

USAAMRDL-TR-75-29

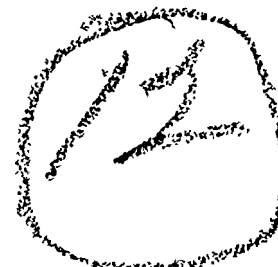

CH-47C FIXED-SYSTEM STALL-FLUTTER DAMPING



413

Boeing Vertol Company
A Division of The Boeing Company
P. O. Box 16858
Philadelphia, Pa. 19142

AD A 0 1 4 8 9 0

August 1975

Final Report for Period February 1974 to March 1975

Approved for public release;
distribution unlimited.

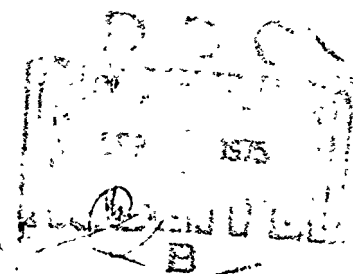

Prepared for
EUSTIS DIRECTORATE
U. S. ARMY AIR MOBILITY RESEARCH AND DEVELOPMENT LABORATORY
Fort Eustis, Va. 23604

UNCLASSIFIED

SECURITY CLASSIFICATION OF THIS PAGE (When Data Entered)

REPORT DOCUMENTATION PAGE		READ INSTRUCTIONS BEFORE COMPLETING FORM
1 REPORT NUMBER 18 USAAMRDL-TR-75-29	2 GOVT ACCESSION NO	3 RECIPIENT'S CATALOG NUMBER
4 TITLE (and Subtitle) CH-47C FIXED-SYSTEM STALL-FLUTTER DAMPING		5 TYPE OF REPORT & PERIOD COVERED Final Report Feb 1974 to Mar 1975
7 AUTHOR(s) Joseph M. Baskin		6 PERFORMING ORG. REPORT NUMBER
9 PERFORMING ORGANIZATION NAME AND ADDRESS Boeing Vertol Company A Division of The Boeing Company P.O. Box 16858, Philadelphia, Pa. 19142		8 CONTRACT OR GRANT NUMBER(s) DAAJ92-74-C-0029
11 CONTROLLING OFFICE NAME AND ADDRESS Eustis Directorate, U.S. Army Air Mobility Research and Development Laboratory, Fort Eustis, Va. 23604		10 PROGRAM ELEMENT, PROJECT, TASK AREA & WORK UNIT NUMBERS 62208A 1F262208AH90 01 009 EK
14 MONITORING AGENCY NAME & ADDRESS (if different from Controlling Office)		12 REPORT DATE Aug 1975
16 DISTRIBUTION STATEMENT (of this Report) Approved for public release; distribution unlimited.		13 NUMBER OF PAGES 32
17 DISTRIBUTION STATEMENT (of the abstract entered in Block 20, if different from Report)		15 SECURITY CLASS (of this report) Unclassified
13 SUPPLEMENTARY NOTES		15a DECLASSIFICATION/DOWNGRADING SCHEDULE
19 KEY WORDS (Continue on reverse side if necessary and identify by block number) CH-47C helicopter Rotor-control system Stall flutter Pitch-link loads Fixed-link loads Pivoting-actuator loads Damping		
20 ABSTRACT (Continue on reverse side if necessary and identify by block number) This program was conducted to evaluate the effect of fixed-system damping on stall-induced control loads. Damping was introduced into the CH-47C aft-rotor control system by connecting the housing portion of the linear damper to the longitudinal-trim system and grounding the piston portion of the damper to the aft transmission. Five damper-rate configurations were evaluated on a helicopter with a gross weight of 40,000 pounds. Data obtained		

DD FORM 1473 1 JAN 73 EDITION OF 1 NOV 65 IS OBSOLETE

UNCLASSIFIED
SECURITY CLASSIFICATION OF THIS PAGE (When Data Entered)

UNCLASSIFIED

SECURITY CLASSIFICATION OF THIS PAGE(When Data Entered)

20. ABSTRACT (Continued)

→ In speed sweeps at five density altitudes to 10,000 feet indicate that the rotating-system loads were reduced by 16 percent and the fixed-system loads were reduced by 22 percent. The program proved that fixed-system damping is effective in reducing stall-induced control loads. Recommendations are presented for reducing these loads by softening the swashplate support as well as by increasing the effectiveness of the fixed-system damper.

UNCLASSIFIED

SECURITY CLASSIFICATION OF THIS PAGE(When Data Entered)

Summary

This program was conducted to determine the degree to which the first torsional mode of the CH-47C rotor blade is coupled to the pitching mode of the swashplate during stall flutter, and to determine whether incorporation of fixed-system damping of this mode would suppress the flutter. Damping was introduced in the longitudinal branch of a CH-47C aft-rotor fixed control system. The design of the damper installation was predicated on a previously conducted analog study which evaluated the fixed-system damping on the four-bladed Boeing Model 347 helicopter, and which has essentially the same control-system mass and stiffness characteristics as the three-bladed CH-47C rotor system. Damper-installation hardware was fabricated and control-system components were instrumented at Boeing Vertol.

Flight testing was conducted by USAAEFA, Edwards AFB at a nominal gross weight of 40,000 pounds; maneuvers included climbs, level-flight speed sweeps, and banked turns at density altitudes ranging from 2,800 feet to 10,000 feet. Four damper configurations were flight tested with damping rates of 200, 380, 500, and 1,050 lb-sec/in. and compared to a baseline flight with no damper. The results indicate that significant reductions in rotating and nonrotating control-component loads were achieved with the 1,050 lb-sec/in. damper. The alternating pitch-link loads were reduced by 16 percent, while in the fixed control system the pivoting actuator loads were reduced by 28.5 percent, and the fixed-link loads reduced by 22 percent.

The damper was well located from the standpoint of its access to the fixed-system motions involved in the flutter mode, but the motions were not sufficient for the complete damping of the flutter. A reduction of stiffness in the swashplate pitching mode would increase the motion of the damper, and correspondingly the damper effectiveness. Previous analytical work also indicates that this softening of the swashplate support would reduce the tendency to flutter.

The steady and vibratory loads in the cyclic-trim linkage are so related that motions across the control system's mechanical free play could be a significant part of the stall-flutter motion, depending on the magnitude of the free play. For this reason it is recommended that future testing include the determination of the effects of control-system free play on the stall-flutter responses.

Preface

The design, fabrication, and testing of the CH-47C aft-rotor fixed-system control damper were performed under contract DAAJ02-74-C-0029 with the Eustis Directorate, U.S. Army Air Mobility Research and Development Laboratory, Fort Eustis, Virginia.

The work was performed under the general direction of Mr. Paul Mirick, Technology Applications Division of the Eustis Directorate. Principal participants at the Boeing Vertol Company were Glidden Doman, program manager, Joseph Baskin, project engineer, Paul Gotchel, Dean Shauger, Joseph Fries, and Richard Moore.

The test aircraft was flown at USAAEFA, Edwards AFB, California, by Captain Louis Kronenberger, project engineer and copilot, and Joseph Watts, pilot. The Edwards support team also included Henry Sanford, SP/6 Bertram Larsen, Charles Benner, and Joseph Lamb. Assistance in the preparation for the safety-of-flight review and recommendations related to the conduct of the flight-test program came from Harry Chambers of Flight Standards, AVSCOM, St. Louis, Missouri.

TABLE OF CONTENTS

<u>Part</u>		<u>Page</u>
	Summary	1
	Preface	2
	List of Illustrations	4
1	Controlling Stall Flutter	5
2	Test-Program Hardware	8
3	Flight Testing	12
4	Data Analysis	20
5	Conclusions	30
6	Recommendations	32

LIST OF ILLUSTRATIONS

<u>Figure</u>		<u>Page</u>
1	Cyclic-Trim Linkage for the CH-47C Helicopter . . .	6
2	Installation of Stall-Flutter Damper on CH-47C Aft Rotor	9
3	Fuse-Joint Test Specimen After Ultimate-Load Pull Test	11
4	Profile of Typical Flight-Test Mission for Flights 1 Through 5	14
5	Test Aircraft for the Fixed-System Stall- Flutter Damper--CH-47C No. 69-17126	15
6	Layout of Data-Acquisition System	16
7	Cockpit Instrument Panel of Test Aircraft With Cruise-Guide Indicator Installed	17
8	Stall Effects of Harmonic Pitch-Link Loads Without Damping ($C_T/\sigma = 0.105$)	21
9	Stall Effects on Harmonic Pitch-Link Loads With a Damper Rate of 500-Lb-Sec/In. ($C_T/\sigma = 0.105$)	22
10	Stall-Induced Rotor Loads From Baseline Flight (No Damper)	23
11	Aft-Rotor Control and Damper Loads for Three Damper Configurations	25
12	Alternating Pitch-Link Loads as Affected by Fixed-System Damping	26
13	Alternating Fixed-Link Loads (Longitudinal Cyclic System) as Affected by Fixed-System Damping	26
14	Alternating Pivoting-Actuator Loads (Collective and Lateral-Cyclic Systems) as Affected by Fixed-System Damping	27
15	Pitch-Link Loads as a Function of Damper Rate ($\mu = 0.25$)	28
16	Fixed-Link Loads as a Function of Damper Rate ($\mu = 0.25$)	29
17	Pivoting-Actuator Loads as a Function of Damper Rate ($\mu = 0.25$)	29

I. Controlling Stall Flutter

THE NATURE AND EFFECT OF STALL FLUTTER

When stall of the retreating-blade tip occurs, helicopters flying at high forward speeds and producing high values of thrust often display high-frequency vibratory blade-pitching moments greater than those attributable to the stalling of the airfoil. Time histories of pitch-link loads and theoretical investigations indicate that the blades can be excited in a growing first-mode torsional oscillation by the progressive stalling, unstalling, and restalling of the outboard portion of the blade. Energy is fed into the motion by aerodynamic moments which are in phase with the pitching motion of the blade.¹ Since the loads induced by stall flutter are usually reacted in the fixed control system, spring deflections and inertial effects in the fixed system may couple with the actions of the blade. If a substantial portion of the total flutter deflection occurs in the nonrotating system, damping introduced below the swashplate can prevent or limit the growth of stall-flutter control-system loads.

FIXED-SYSTEM VERSUS ROTATING-SYSTEM DAMPING

It has been shown that stall-induced control loads can be reduced in the rotating control system by replacing the standard pushrod with a spring-damper pushrod. However, this approach adds weight and the complexity of additional mechanisms in each blade's pitch control.² In addition, the attendant blade-pitch deflections require close matching of the individual spring-dampers and blades to maintain blade track and rotor smoothness. These problems are largely avoided when the damping is placed in the fixed system.

¹ See Gabel, R., and Tarzanin, F., Jr., BLADE TORSIONAL TUNING TO MANAGE LARGE AMPLITUDE CONTROL LOADS, Journal of Aircraft, Vol. 11, No. 8, August 1974, pp. 460-466.

² See Adams, David O., THE EVALUATION OF A STALL-FLUTTER SPRING-DAMPER PUSHROD IN THE ROTATING CONTROL SYSTEM OF A CH-54B HELICOPTER, Sikorsky Aircraft Division, United Aircraft Corporation; USAAMRDL Technical Report 73-55, Eustis Directorate, U.S. Army Air Mobility Research and Development Laboratory, Fort Eustis, Virginia, August 1973.

In fixed-system damping (damper located below the swashplate), the positioning of the damper must be such that the maximum swashplate motion (whether in the pitch, roll, or collective mode) which is related to flutter, will be imparted to the damper. The maximum flutter motion in the CH-47C rotor-control system occurs when the pitch link of the fluttering blade is at or near the roll axis of the swashplate, thus producing maximum motion in the longitudinal trim system. The installation of a damper in the longitudinal system of the CH-47C is mechanically simple, and the fact that the various swashplate motion modes are decoupled makes it possible to reduce the stiffness at the pitching mode to improve the damping activity and still maintain blade track. A stiffness reduction in that mode would also reduce the flutter mode frequency, and analytical studies show that this can be a favorable effect from the standpoint that the blade moves out of the stallable region before completing as many flutter cycles.

CHARACTERISTICS OF THE CH-47C CONTROL SYSTEM

The mechanical arrangement which segregates the pitch and roll restraints of the swashplate is shown in Figure 1. Roll

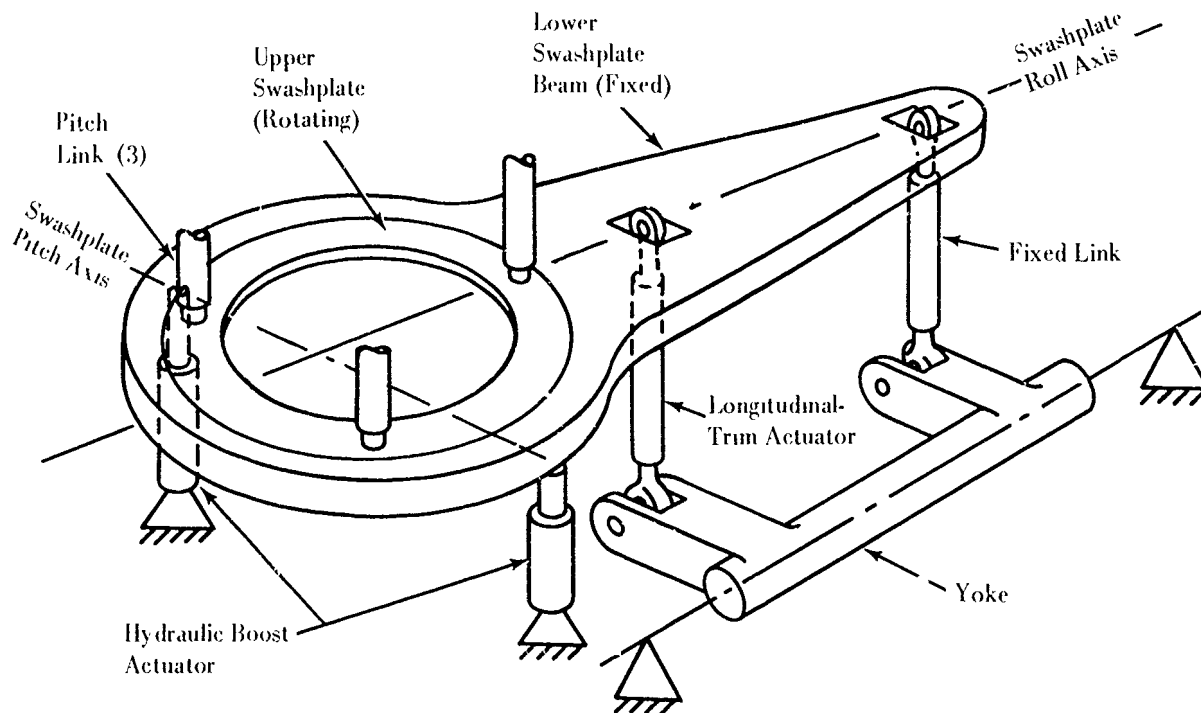

Figure 1. Cyclic-Trim Linkage for the CH-47C Helicopter.

restraint of the swashplate is very stiff (2.2×10^6 in.-lb/rad at the blade) and is damped by the hydraulic boost actuators. The swashplate pitching restraint is considerably softer (1.15×10^6); it consists of linkages which are not tied directly to ground and which introduce longitudinal cyclic control for trim through an electrical screwjack. The absence of damping in the swashplate pitching mode means that this branch of the system can couple with blade torsion without significant damping effect upon freedom of the blade to move in stall flutter. When the blade stalls (at an azimuth angle of 260 to 280 degrees), its pitch link loads this soft, undamped branch of the control system. Thus, the blade can flutter and take the control system along with it in the undamped pitching mode of swashplate motion. Flight-test data on the CH-47C in stall flutter at high forward speed and high rotor thrust suggests that the flutter involves this pitching motion of the swashplate.

Calculation of the blade-pitching amplitude associated with measured stall-flutter loads in the pitch links shows that 23 percent of the flutter deflection occurs in the non-rotating cyclic-trim system. The other 77 percent occurs in the rotating system, principally in the blade itself. Thus, 23 percent of the total spring deflection is accessible in the fixed system, where it can be shunted easily by damping; this is much more practical than trying to shunt the blade torsional deflection. The damping of this fixed-system deflection could conceivably absorb the hysteresis energy of the stall-unstall pitching moments and thus preclude flutter.

ANALOG PITCH-DAMPER SIMULATION

The feasibility of fixed-control-system damping in reducing Chinook pitch-link and fixed-system loads was analyzed by means of an analog simulation of the coupled rotor and swashplate for the Boeing Model 347 helicopter,³ which used four CH-47C blades and the control-system components of a CH-47C helicopter. To ensure the presence of stall flutter, a flight condition with $\mu = 0.405$ and $C_T/\sigma = 0.105$ was simulated.

Results indicate a reduction of flutter loads in the pitch link of about 25 percent for a damper in the cyclic-trim branch of the control system with a damping coefficient of 80

³See Fries, Joseph C., ANALOG ANALYSIS OF PROPOSED FLIGHT TEST PITCH DAMPING, IOM 8-7475-1-648, Boeing Vertol Company internal document, October 1973.

lb-sec/in. and with a predicted stroke of ± 0.050 in. For the simulation the damper was located directly under the fixed-link attachment to the yoke.

The simulation allowed independent blade torsional motions and a rigid swashplate free to pitch, roll, and move collectively. Complex airloading, including unsteady and nonlinear effects, were continually integrated independently along the individual blades as they rotated about the azimuth. The coupled effects of swashplate dynamic motions feeding into the blade aerodynamics were also a salient feature of the simulation.

The swashplate impedance as seen by the rotating blades was accounted for by springs, masses, and dampers distributed in the fixed control system about the azimuth. The results of this simulation, along with the experience gained in handling the complexities of an analysis which simulates real hardware, generated enough incentive to test the postulate that fixed-control-system damping is an effective means of reducing and possibly eliminating stall-flutter loads.

2. Test-Program Hardware

DESIGN CONSIDERATIONS

The analog study of fixed-system damping in the longitudinal branch of the Boeing Vertol Model 347 rotor system was concerned not with how to incorporate the damper into the system but just the representation of the damper in an equivalent electrical circuit. This is one of the problems the designer faces when he is asked to accomplish in hardware what the analyst has already accomplished in equations. Such was the problem with the installation of a damper in the aft rotor control of the CH-47C, which finally evolved to that shown in Figure 2.

No space was available for installing a damper under the fixed-link arm of the yoke, the assembly which connects the yoke to the aft-pylon deck. Consideration was given to using a modified blade-lag damper; since the damper was readily available and adaptable by simply eliminating the preload and change the basic damping rate. However, the damper modification costs were felt to be excessive and so several vendors were contacted to determine availability of off-the-shelf dampers. Sterer Engineering and Manufacturing Company offered a damper that could be easily modified to change its rate.

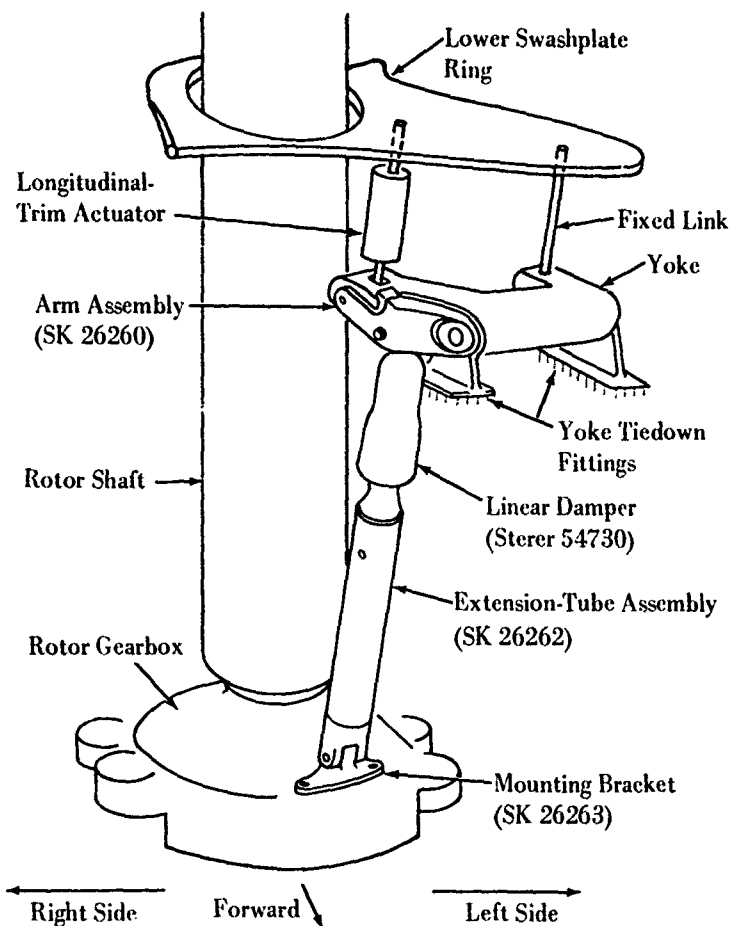

Figure 2. Installation of Stall-Flutter Damper on CH-47C Aft Rotor.

This damper was designed as a linear control-surface flutter damper for the Lockheed L-1011 jet transport. Sterer was selected to supply the damper on the basis of cost as well as on the ease of modification. Initially, three dampers were ordered with rates of 170, 250, and 425 lb-sec/in., based on requirements for operating at 12 cps. The rates required for the CH-47C test were intended to bracket the required value, which was the 347 rate, amplified to account for location differences. One of the dampers Boeing was to purchase and the other two were to be shipped on consignment. Having three dampers available would permit fast removal and replacement at the Edwards flight-test facility.

The dampers which were delivered, however, had rates different from those initially requested--200, 380, and 500 lb-sec/in. These were accepted because it was felt that they provided a sufficiently broad range of damping rates for evaluation. During the aircraft modification and checkout phase of the program, consideration was given to the possibility that

the rate range was not wide enough to cover a load-rate bucket, if it existed. Therefore, before the first flight, a fourth damper was ordered with a rate of 1,050 lb-sec/in., a rate slightly beyond what appeared to be the bottom of a bucket in the results of the analog study.

DESIGN LOADS

Design loads were predicted for two basic conditions. The first condition was limit loads which are produced by the rapid change of collective. This involves a pushdown on the stick to produce a blade-angle change of 16 deg/sec during entry into autorotation, or a pullup on the stick to produce a blade-angle change of 55 deg/sec during an autorotative flare. The second condition was fatigue, and these loads were based on the motions at the damper predicted in the Model 347 analog study. The predicted fatigue loads were amplified by a factor of 2.0 in the analyses of damper-installation structures, with the exception of the fuse joint. Table 1 contains a summary of component margins of safety.⁴

TABLE 1. COMPONENT-STRENGTH SUMMARY					
Part & Number	Material	Strength (psi)		Failure Mode	Margin of Safety
		Fatigue	Ultimate		
Yoke SK 26259	4340 steel	±25,000	147,000*	Bending fatigue	+0.52
Arm Assembly SK 26260	2024-T3 aluminum	±2,000	62,000		+0.52
Ext-Tube Assembly SK 26262-1:				Column stability	+0.72
--Fitting	4340 steel	±35,000	147,000*	Axial & bending fatigue	+0.08
--Tube	2024-T3 aluminum	±2,000	62,000	Axial fatigue	+0.10
Mounting Bracket SK 26262	4340 steel	±10,000	147,000*	Lug-tension fatigue	+0.31
*Minimum					

SAFETY FEATURES

The damper installation was designed with failsafety in mind. Where a component did not have an alternate load path

⁴For stress analyses of damper installation, see Baskin, Joseph M., SAFETY OF FLIGHT ANALYSIS, INVESTIGATION OF CH-47C FIXED SYSTEM STALL FLUTTER DAMPING, D210-10853-1, Boeing Vertol Company, October 1974.

in case of failure, additional material was incorporated and reasonably high margins of safety were maintained, even though the fatigue loads were multiplied by a factor of 2.0, and infinite fatigue lives were predicted on mean- 3σ fatigue-strength data. A fuse joint, shown in Figure 3, was incorporated into

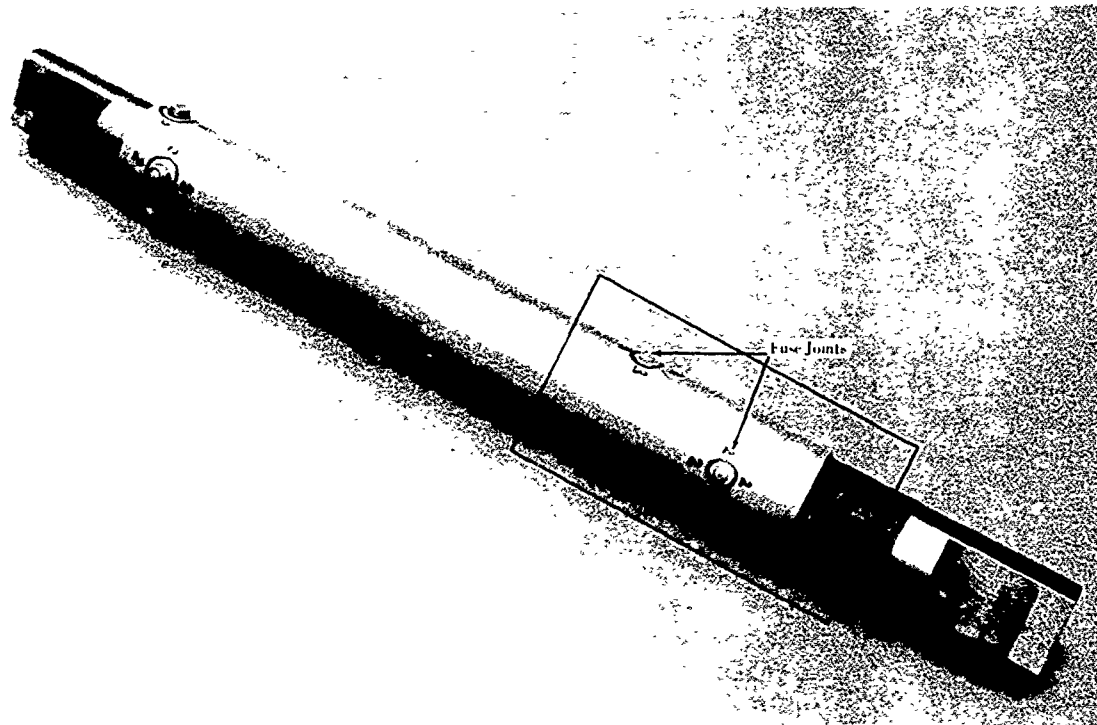

Figure 3. Fuse-Joint Test Specimen After Ultimate-Load Pull Test

the damper extension rod to preclude a damper jam's causing subsequent locking up of the control system and the loss of aircraft control. The fuse consisted of four blind 3/16-in. aluminum rivets tying the upper-end steel fitting (damper rod to damper piston) to the aluminum extension-rod tube. The design of the connection had several criteria:

- The failure of the fuse should not interfere with the slipping of the end fitting relative to the tube.
- The ultimate strength of the joint should be low enough that it would fail prior to the control system's becoming locked. A criterion was established that the ultimate strength should be less than the sum of the stalling loads of two collective-pitch actuators (6,000 pounds per actuator in tension, and 4,000 pounds per actuator in compression).

- The joint should have the sufficient fatigue life to last through 10 hours of flight testing.
- Failure of the fuse would effectively cause the control system to behave as if no damper were present.

The static strength of the joint was calculated to be 4,620 pounds and failed in static test at 4,600 pounds. To prevent the damper assembly from interfering with other aircraft components in case of a failure of the damper system, bungee cord was used to tie both the damper and the extension rod individually to the forward pylon-bulkhead structure.

3. Flight Testing

The flight testing of the fixed-system stall-flutter damper installed in the aft rotor-control system of an Army CH-47C was conducted at Edwards AFB, California. The program was conducted in three phases:

1. A check flight to ensure proper functioning of hardware and data-acquisition package and to check blade track
2. Basic mission profile for evaluation of five damper configurations (damping rates of 0, 200, 380, and 1050 lb-sec/in.)
3. Banked turns, comparing best damping configuration of phase 2 with no damper, repeated to get statistical data.

The program was successfully concluded, with aircraft and data system each proving to be quite reliable. The data acquired was sufficient to show that with the proper damping rate, fixed-system damping on the CH-47C can significantly reduce stall-flutter loads. A description of the data flights 1 through 7 is presented in Table 2.

During the phase-1 check flight, the nominal takeoff gross weight of the aircraft was 34,000 pounds. However, during phases 2 and 3, the aircraft was flown at a takeoff gross weight of from 41,200 pounds to 41,500 pounds and a nominal gross weight of 40,000 pounds. The aircraft center of gravity was located 5 inches aft of the centerline between rotors. Although the test aircraft operated out of Edwards AFB, flight testing was conducted between Mojave Airport and California City. Variations of nondimensional rotor thrust, (C_T/σ) , were

TABLE 2. FLIGHT-TEST CONDITIONS (DATA FLIGHTS)

Run	Press. Alt (ft)	OAT (°C)	Airspeed			C _d /ρ @ Alt Rotor	Maneuver	Run	Press. Alt (ft)	OAT (°C)	Airspeed			C _d /ρ @ Alt Rotor	Maneuver
			IAS (kn)	TAS (kn)	True						IAS (kn)	TAS (kn)	True		
Flight 1 no Damper TOGW: 41,400 lb							3	7,300	13	88	100	.224	-	Climb at 500 fpm	
1	2,560	10	0	0	0	0	4	8,200	13	88	102	.233	-	-	
1A	-	-	-	-	-	-	5	8,200	13	76	88	.201	.113	Level flight	
2	5,800	6	88	96	.220	-	6	8,200	13	92	107	.2451	.113	-	
3	6,800	2.5	88	98	.224	-	7	8,200	13	100	116	.265	.113	-	
4	7,900	0	88	99	.226	-	8	6,500	15	78	88	.201	.105	-	
5	8,900	-3	88	101	.231	-	9	6,500	15	98	111	.254	.105	-	
6	9,900	-5	88	102	.233	-	10	6,500	15	113	128	.292	.105	-	
7	10,000	-6	76	100	.201	.112	11	4,900	13	80	87	.199	.091	-	
8	10,000	-6	95	110	.252	.112	12	4,900	13	101	110	.252	.090	-	
9	10,000	-8	104	121	.277	.111	13	4,900	14	130	142	.352	.090	-	
9A	-	-	-	-	-	-	14	3,900	15	82	88	.201	.089	-	
10	8,000	-1	78	88	.201	.106	15	3,900	15	102	110	.252	.089	-	
11	8,000	-1	98	110	.252	.105	16	3,900	15	136	146	.334	.089	-	
12	8,000	-1	118	133	.304	.105	17	2,540	15	57	60	.137	.086	-	
13	6,000	4	80	88	.201	.099	18	2,540	14	57	59	.135	.086	30-deg banked left turn	
14	6,000	5	101	111	.254	.099	19	2,500	14	77	80	.183	.086	Level flight	
15	6,000	6	129	142	.325	.099	20	2,500	14	96	100	.229	.086	-	
16	5,000	7	82	89	.204	.096	21	2,500	14	96	100	.229	.086	30-deg banked left turn	
17	5,000	8	102	110	.252	.096	22	2,500	14	105	109	.249	.086	Level flight	
18	5,000	8	115	146	.314	.096	23	2,500	14	110	115	.263	.086	-	
19	2,900	10	57	60	.137	.089	24	2,600	15	144	151	.345	.086	-	
20	2,900	11	57	60	.137	.089	Flight 5 Damper rate: 1.050 lb-sec/in TOGW: 41,250 lb								
21	2,960	10	77	80	.183	.089	1	2,420	14	0	0	0	-	Hover	
22	2,900	11	96	100	.229	.089	2	4,800	16	88	96	.220	-	Climb at 500 fpm	
23	2,900	11	96	100	.229	.089	3	5,600	16	88	98	.224	-	-	
24	2,800	11	105	110	.229	.088	4	6,000	19	58	73	.226	-	-	
25	2,800	12	110	115	.263	.089	5	7,000	19	88	101	.231	-	-	
26	2,800	12	146	153	.250	.089	6	6,200	18	78	88	.201	.107	Level flight	
Flight 2 Damper rate: 200 lb-sec/in TOGW: 41,500 lb							7	6,200	18	98	110	.252	.107	-	
1	2,600	10	0	0	0	0	8	6,200	18	110	124	.284	.106	-	
1A	-	-	-	-	-	-	9	4,800	16	80	87	.199	.100	-	
2	5,900	6	88	96	.222	-	10	4,800	16	101	110	.252	.100	-	
3	6,800	4	88	98	.224	-	11	4,800	16	127	139	.318	.100	-	
4	7,700	3	88	99	.226	-	12	4,000	16	82	88	.201	.097	-	
5	8,700	1	88	101	.231	-	13	4,000	16	102	110	.252	.097	-	
6	9,400	0	88	102	.233	-	14	4,000	16	134	144	.329	.097	-	
7	9,500	-1	76	88	.201	.113	15	2,900	14	57	60	.137	.092	-	
8	9,500	0	95	110	.252	.114	16	2,900	14	57	60	.137	.092	30-deg banked left turn	
8A	-	-	-	-	-	-	17	2,900	15	77	80	.183	.092	Level flight	
9	8,000	2	78	88	.201	.107	18	2,800	15	96	100	.229	.092	-	
10	8,000	2	98	111	.254	.107	19	2,800	15	96	100	.229	.092	30-deg banked left turn	
11	8,100	2	112	127	.290	.107	20	2,650	15	105	110	.252	.090	Level flight	
12	5,900	5	80	88	.201	.100	21	2,650	15	110	115	.263	.090	-	
13	5,900	6	101	111	.254	.100	22	2,600	15	144	150	.343	.090	-	
14	5,900	7	130	143	.327	.100	Flight 6 No damper TOGW: 41,250 lb								
15	4,800	7	82	88	.201	.095	1	2,480	15	0	0	0	-	Hover	
16	4,850	7	102	110	.252	.095	2	4,500	20	88	96	.220	-	Climb at 500 fpm	
17	4,850	8	116	147	.336	.095	3	5,200	20	88	98	.224	-	-	
18	2,900	10	57	60	.137	.089	4	6,100	18	88	99	.226	-	-	
19	2,900	10	57	60	.137	.089	5	6,180	18	53	60	.137	.107	30-deg banked left turn	
20	2,900	10	57	60	.137	.089	6	6,500	16	53	60	.137	.107	-	
21	2,900	10	77	80	.183	.089	7	6,500	16	53	60	.137	.107	-	
22	2,900	10	96	100	.229	.089	8	6,460	16	53	60	.137	.107	-	
23	2,900	11	96	100	.229	.089	9	6,460	16	89	100	.229	.107	-	
24	2,900	12	105	110	.252	.089	10	6,450	16	89	100	.229	.107	-	
25	2,900	11	110	115	.263	.089	11	6,420	16	89	100	.229	.107	-	
26	2,900	12	145	152	.348	.089	12	6,460	16	89	100	.229	.107	-	
Flight 3 Damper rate: 380 lb-sec/in TOGW: 41,450 lb							13	2,400	10	57	59	.135	.089	-	
1	2,620	16	0	0	0	0	14	2,420	10	57	59	.135	.089	-	
1A	-	-	-	-	-	-	15	2,440	10	57	59	.135	.089	-	
2	5,300	10	88	96	.220	-	16	2,440	10	57	59	.135	.089	-	
3	6,500	6	88	98	.224	-	17	2,400	10	96	100	.229	.089	-	
4	7,600	3	88	99	.226	-	18	2,400	10	96	100	.229	.089	-	
5	8,600	1	88	101	.231	-	19	2,380	10	96	100	.229	.089	-	
6	9,500	1	88	103	.236	-	20	2,400	10	96	100	.229	.089	-	
7	9,500	2	76	88	.201	.108	Flight 7 Damper rate: 1.050 lb-sec/in TOGW: 41,200 lb								
8	9,560	2	96	112	.256	.108	1	2,600	25	0	0	0	-	Hover	
8A	-	-	-	-	-	-	2	4,300	20	88	96	.220	-	Climb at 500 fpm	
9	7,800	3	78	88	.201	.104	3	5,500	18	88	98	.224	-	-	
10	7,800	4	98	111	.254	.104	4	6,500	15	88	99	.226	-	-	
11	7,920	5	115	131	.300	.104	5	6,600	15	89	100	.229	.107	30-deg banked left turn	
12	5,800	7	80	88	.201	.099	6	6,500	15	89	100	.229	.107	-	
13	5,800	7	101	111	.254	.099	7	6,400	15	89	100	.229	.107	-	
14	5,800	8	130	143	.327	.099	8	6,400	15	89	100	.229	.107	-	
15	4,500	10	82	88	.201	.096	9	6,400	15	89	100	.229	.107	-	
16	4,500	10	102	110	.252	.096	10	2,500	23	96	102	.233	.094	-	
17	4,500	12	116	147	.336	.096	11	2,500	23	96	102	.233	.094	-	
18	3,000	15	57	60	.137	.089	12	2,500	23	96	102	.233	.094	-	
19	3,000	15	57	60	.137	.089	13	2,520	24	96	102	.233	.094	-	
20	3,000	15	57	60	.137	.089	14	2,550	23	96	102	.233	.094	30-deg banked right turn	
21	3,000	15	77	80	.183	.089	15	2,600	23	96	102	.233	.094	-	
22	3,000	16	96	100	.229	.089	16	2,600	23	96	102	.233	.094	-	
23	3,000	16	96	100	.229	.089	17	2,550	23	96	102	.233	.094	-	
24	3,000	16	105	110	.252	.089	18	2,500	23	96	102	.233	.094	40-deg banked left turn	
25	3,000	16	110	115	.263	.089	19	2,500	24	96	102	.233	.094	-	
26	3,000	16	145	153	.350	.089	20	2,500	24	96	102	.233	.094	-	
Flight 4 Damper rate: 500 lb-sec/in TOGW: 41,200 lb							21	2,500	24	96	102	.233	.094	-	
1	2,500	14	0	0	0	0	22	2,500	24	96	102	.233	.094	40-deg banked right turn	
2	6,200	14	88	98	.224	-	23	2,500	24	96	102	.233	.094	-	
Flight 5 no Damper TOGW: 41,400 lb							24	1,500	24	96	102	.233	.093	-	
3	7,300	13	88	100	.224	-	25	2,							

achieved by flying airspeed speed sweeps at density altitudes ranging from 2,800 feet to 10,000 feet. The aircraft was operated within the limits agreed upon during the safety-of-flight review and summarized in the safety-of-flight release, dated 10 October 1974, and its subsequent amendment.

MISSION PROFILE

Figure 4 illustrates the mission profile flown for the five damper configurations. It was initially expected that the top of the profile would be at 12,000 feet density altitude. However, it became apparent on the baseline flight (flown with no damper) that 10,000 feet density altitude would be the maximum test altitude. The turbine-inlet temperature reached the temperature limit for continuous operation at that altitude during the climb portion of the mission. Limits for continuous operation were not to be exceeded during this test program.

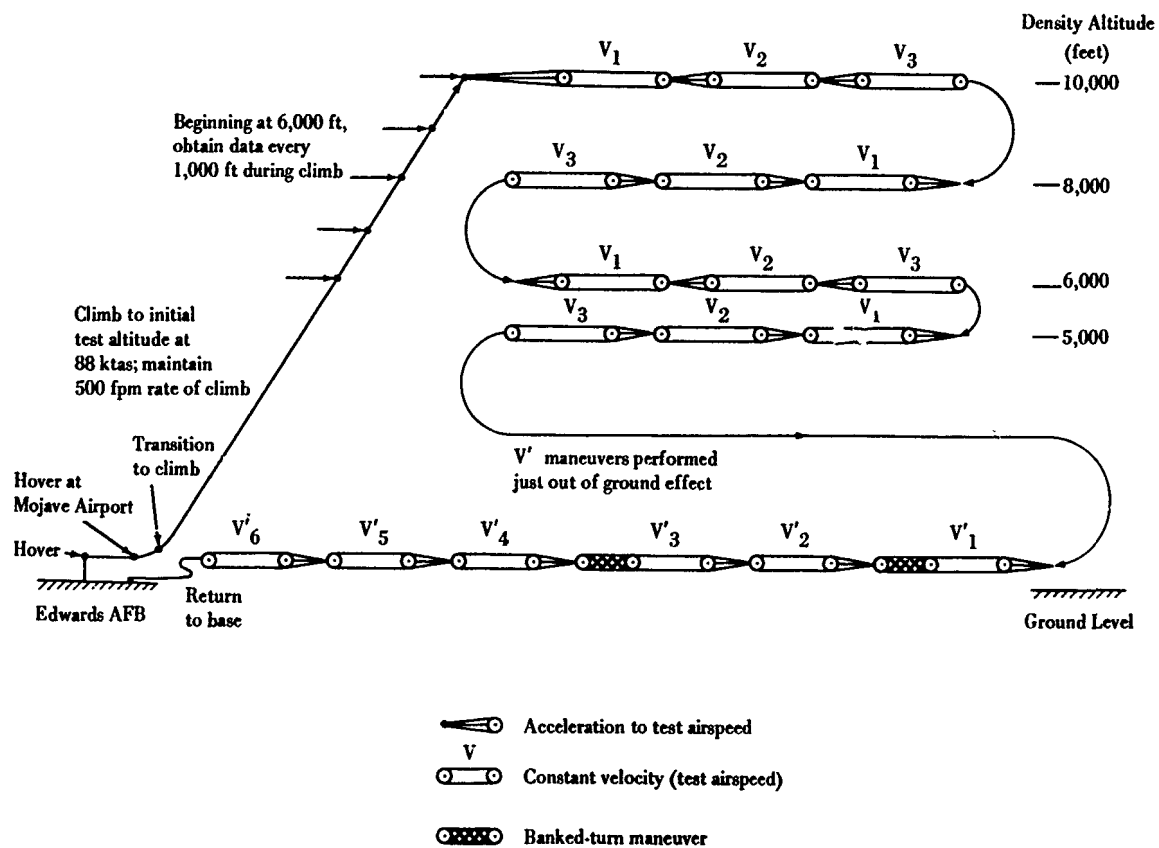

Figure 4. Profile of Typical Flight-Test Mission for Flights 1 Through 5.

DESCRIPTION OF AIRCRAFT

The test aircraft was a CH-47C Chinook based at Edwards AFB and flown during the program by USAAEFA pilots and crew. A description of the aircraft is presented below, and a photograph in Figure 5.

Helicopter type	CH-47C
Aircraft number	69-17126
Engine manufacturer	Avco/Lycoming
Engine type (2)	T55-L-11A
Maximum power	3,750 shp, sea level, standard
Maximum continuous power .	3,000 shp, sea level, standard
Test gross weight	40,000 lb
Rotor configuration	Tandem, fully articulated
Blades per rotor	3
Rotor speed	235 rpm
Blade type	Constant chord, NACA 23010 modified
Rotor radius	30 ft
Blade twist (theoretical).	Linear, 9.15 deg
Blade chord	25.25 in.

The desired gross weight was achieved by using lead-shot ballast and fuel management.



Figure 5. Test Aircraft for the Fixed-System Stall-Flutter Damper--
CH-47C No. 69-17126.

INSTRUMENTATION

All measurements with the exception of fuel quantity and outside air temperature were recorded by an onboard magnetic-tape data-acquisition system. No telemetry was used during this program. The parameters measured and the instrumentation code numbers are presented in Table 3; Figure 6 shows the location of the instrumentation. The cockpit instrument panel is shown in Figure 7, which also shows the cruise-guide indicator installed for the test program.

TABLE 3. AIRCRAFT INSTRUMENTATION					
Instr Code No.	Parameter Measured	Units	Instr Code no.	Parameter Measured	Units
6240	Airspeed	kn	2129	Aft swashplate to struc pos	in.
6131	Altitude	ft	5490*	Flutter-damper load	lb
1350	Accelerometer, c.g., vertical	g	2130*	Flutter-damper pos	in.
5460	Aft pivoting-actuator load	lb	5491*	Extension-tube bending, 0-deg	lb-in.
2123	Aft pivoting-actuator pos	in.	5493*	Extension-tube bending, 90-deg	lb-in.
5461	Aft swiveling-actuator load	lb	3674	Cruise-guide indicator output	v
2121	Aft swiveling-actuator pos	in.	3604	Aft rotor l/rev	-
5487	Aft cyclic-trim actuator load	lb	148 ²	Vertical accel, aft xmsn	g
2128	Cyclic-trim-actuator to struc pos	in.	1484	Lateral accel, aft xmsn	g
5481	Aft fixed-link load	lb	1485	Longitudinal accel, aft xmsn	g
2127	fixed-link to struc pos	in.			
5451	Aft yellow pitch-link load	lb			

*Instrumentation attached to damper. Damper and its extension tube assembly were not in aircraft for baseline flight.

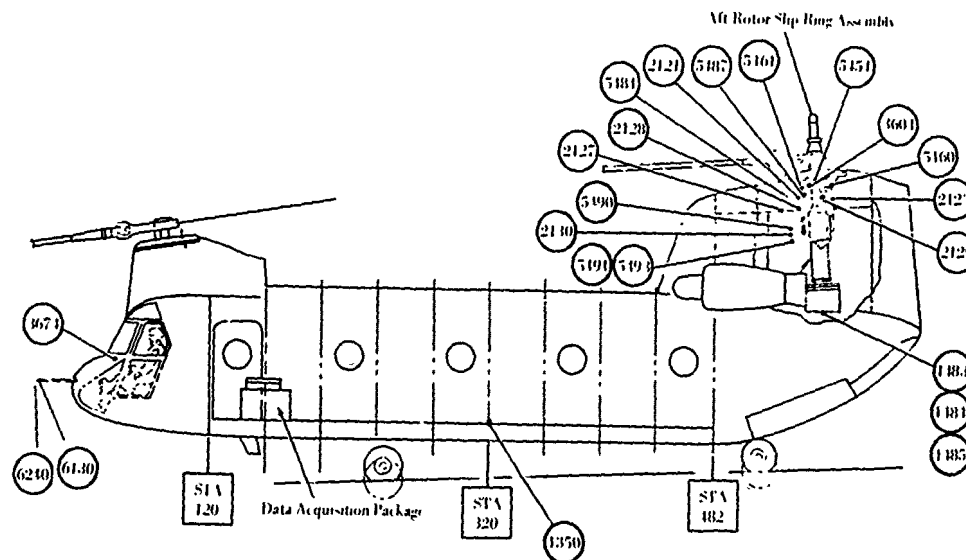

Figure 6. Layout of Data-Acquisition System.

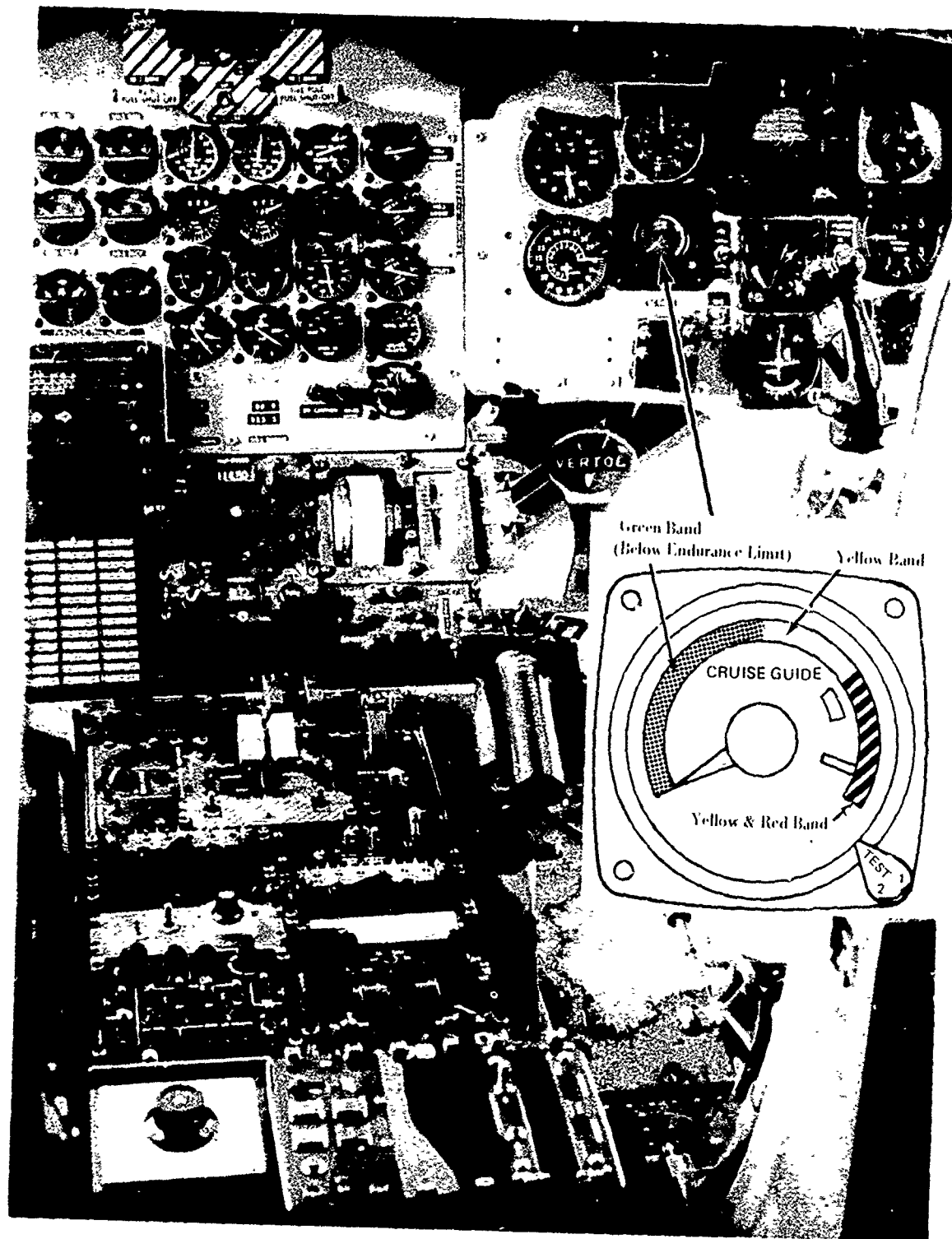

Figure 7. Cockpit Instrument Panel of Test Aircraft
With Cruise-Guide Indicator Installed.

DESCRIPTION OF CRUISE GUIDE SYSTEM

The cruise-guide indicator gives the pilot a visual indication of occurrence of fatigue damage on the upper-control components of the helicopter. The system measures the alternating loads in two rotor-control components, the aft fixed link and the aft pivoting actuator. The loads are converted into percentages of a monitor load level chosen for each of the two components. The higher of these two percentages is displayed to the pilot and copilot continuously. The monitor load levels are determined so that with a 100-percent load level indicated on the cockpit display unit, the alternating load in any fatigue critical component protected by the system does not exceed its endurance limit during level flight with programmed trim.

The system consists of two strain-gage bridges, a cockpit indicator, and the necessary interconnecting wiring. Cockpit readout is accomplished by means of a pointer and dial indicator. The face of the dial is divided into three areas, green, yellow, and yellow with red stripes. The green zone extends from 9 percent to 100 percent of the monitor load level, the yellow from 100 percent to 150 percent, and the striped zone from 150 percent to 200 percent. The intent is that all level flight should be conducted with the pointer in the green zone. If it moves into the yellow zone, airspeed should be reduced until the pointer returns to the green zone. It is expected that normal maneuvers may cause the pointer to move into the yellow zone, but if the striped area is reached, airspeed or maneuver severity should be reduced such that the pointer does not exceed the yellow zone.

Installation of the cruise-guide system on the test aircraft was required so that the pilot would have a visual display of critical rotor-component alternating loads in order that fatigue limits would not be exceeded during the test.

DATA ACQUISITION

Five flights were made following the typical mission profile of Figure 4, with each flight concerned with the evaluation of one of five fixed-system damper configurations. Data was acquired during hover at Mojave Airport, during transition to climb, during the climb at the indicated altitudes, during the speed sweeps at each test altitude, and during the turns conducted at near ground level. Even though most flights were conducted in the early morning hours, temperature inversions and gusts were encountered which made data analysis somewhat difficult. Data bursts were of 15 to 20 seconds duration.

STALL-FLUTTER-DAMPER FLIGHT TESTS

The order of the tests was selected to minimize the fatigue loading on the fuse joint and thereby maintain a high probability that the program would be completed without incident. Therefore, the program started with the baseline configuration (no damper) and proceeded through the first five flights, changing to the next-higher-stiffness damper after each flight. Damper loads were well below the design damper load, so increased confidence was gained as the program continued. When the first five flights were completed, a review of the data indicated that the stiffest damper, with a rate of 1,050 lb-sec/in. produced the best results.

Flights 6 and 7 were flown to obtain statistical data on the effectivity of the best damper configuration in a series of 30-degree and 40-degree banked turns. Four turns were made for each set of flight conditions, which included variations in flight speed, altitude, and bank angle for both the baseline configuration and the 1,050 lb-sec/in. damper configuration.

The dampers were easily removed and replaced; the change time was about one-half to three-quarters of an hour.

In general, the cruise guide indication remained in the green zone (up to 100 percent of endurance limit of critical rotor component), throughout the flight program with the exception of the encounter with rotor lift stall experienced during flights 1 and 2. Higher C_T/σ values could have been achieved had the turbine inlet temperature limits been exceeded.

SPECIAL NOTE ON TEST-FLIGHT 5

During the post flight inspection of the damper installation, it was found that a shoulder bushing in the upper damper attachment had failed, with the shoulder portion separated from the sleeve. A stress analysis of the installation revealed that the preloading of the bolt at the installation put bending stresses at the inboard end of the shoulder sufficient to cause yielding. The preload call-out was reduced to about half of the previous value. The bushing was replaced and the program continued without incident.

Since the damper's axial motion had not been hindered or impeded by the bushing failure, it was decided that flight 5 need not be repeated.

4. Data Analysis

All flight data, with the exception of fuel quantity, pressure altitude, and outside air temperature, were recorded by the onboard data-acquisition system. The exceptions were visually monitored on the pilot's instrument panel and recorded on the pilot's run card. Each run, or data point, is identified in Table 2.

The magnetic-tape data was displayed on oscillograph paper after each flight to assess the quality of the data and to compare the results with the previous flight's data, on a run-for-run basis. That is to say, comparisons of configuration loads were made for the same C_T/σ and μ . Playback paper speed was 1 in./sec, therefore the waveforms were not discernible. However, stall-flutter spiking was clearly definable. In essence, the stripouts at the Edwards AFB facility were basically for troubleshooting and to give on-the-spot indications of progress. Noise in the data in the form of a 0.63Ω as well as low-amplitude hash made full use of the stripout data impractical.

The stripout process was repeated at Vertol, but on a selected-parameter basis and at a much slower paper speed for study of waveforms. The selected parameters included all measured actuator and link loads and deflections. All the load parameters and the 1Ω were stripped out at a paper speed of 8 in./sec for all level-flight conditions only. Because all flights in the Edwards area included some turbulence, it was decided that harmonic analyses as well as the general parametric studies involving load amplitude, advance ratio, and rotor thrust would have to utilize selected data. Such data would be for unaccelerated level flight. A specific rotor cycle from each run was selected for analysis by using the cruise-guide trace and the cg accelerometer trace as guides for meeting the criterion stated above. The harmonic analyses not only included the reference rotor cycle, but the three preceding and three succeeding rotor cycles. Harmonic analyses were performed on both load and deflection data, converting the magnetic-tape data into a digitized form and then performing a Fourier analysis on the digitized data. The computer output included not only the harmonic coefficients but also phase angles up to 12Ω .

RESULTS OF HARMONIC ANALYSES

The harmonic-load analyses indicate that a significant change in the harmonic makeup of the loads occurred going from the unstalled to the stalled condition. Figure 8 shows the

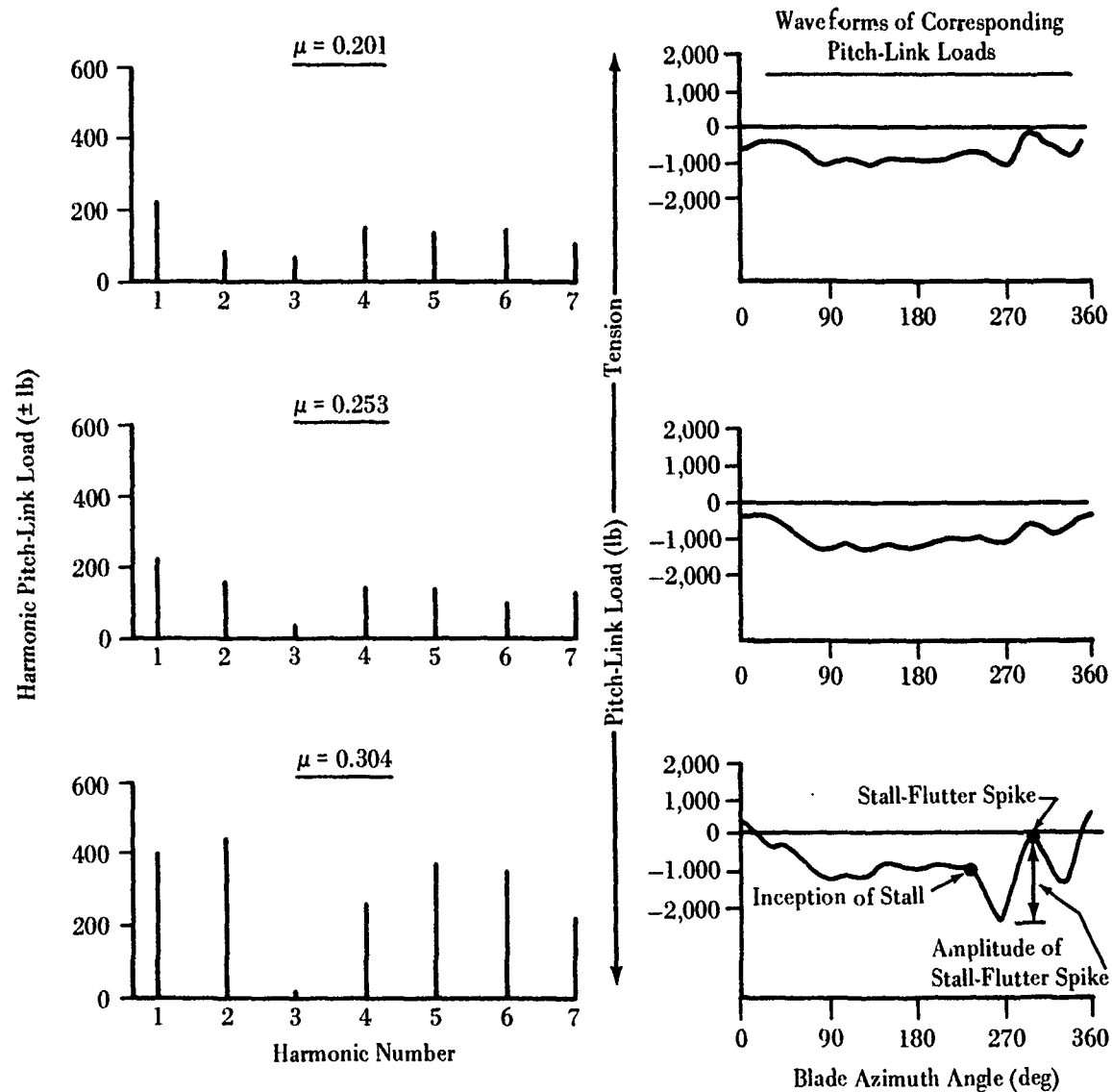

Figure 8. Stall Effects of Harmonic Pitch-Link Loads Without Damping ($C_T/\sigma = 0.105$).

change in the harmonic pitch-link loads for the baseline configuration as the rotor penetrates into the stall regime. Along with the harmonic loads are the corresponding waveforms obtained directly from the flight tapes. Very little change in the harmonic content can be discerned as the flight speed increases from $\mu = 0.20$ to 0.25, the most significant change being the doubling of the 2Ω loading. As the flight speed increased to $\mu = 0.304$, the rotor definitely encountered stall flutter, as seen in the accompanying waveform. The harmonic analysis indicates significant changes in all harmonics, with the most dramatic being in 1Ω , 2Ω , 5Ω , and 6Ω loads. The 1Ω

and 2Ω increases are much greater than would be expected based on a μ^2 trend, because of a combination of μ^2 effect along with the aft movement of the aerodynamic center during the stalling process. The large changes of 5Ω and 6Ω loads are due to the Fourier representation of the 5.7Ω flutter-mode response.

A comparison of the harmonic loads and waveforms for the no-damping configuration shown in Figure 8 with the 500 lb-sec/in. damper configuration data displayed in Figure 9 indicates that damping does not significantly alter the magnitude of the pitch link's harmonic loads, even in the stall-flutter regime. This was typical for all damper configurations.

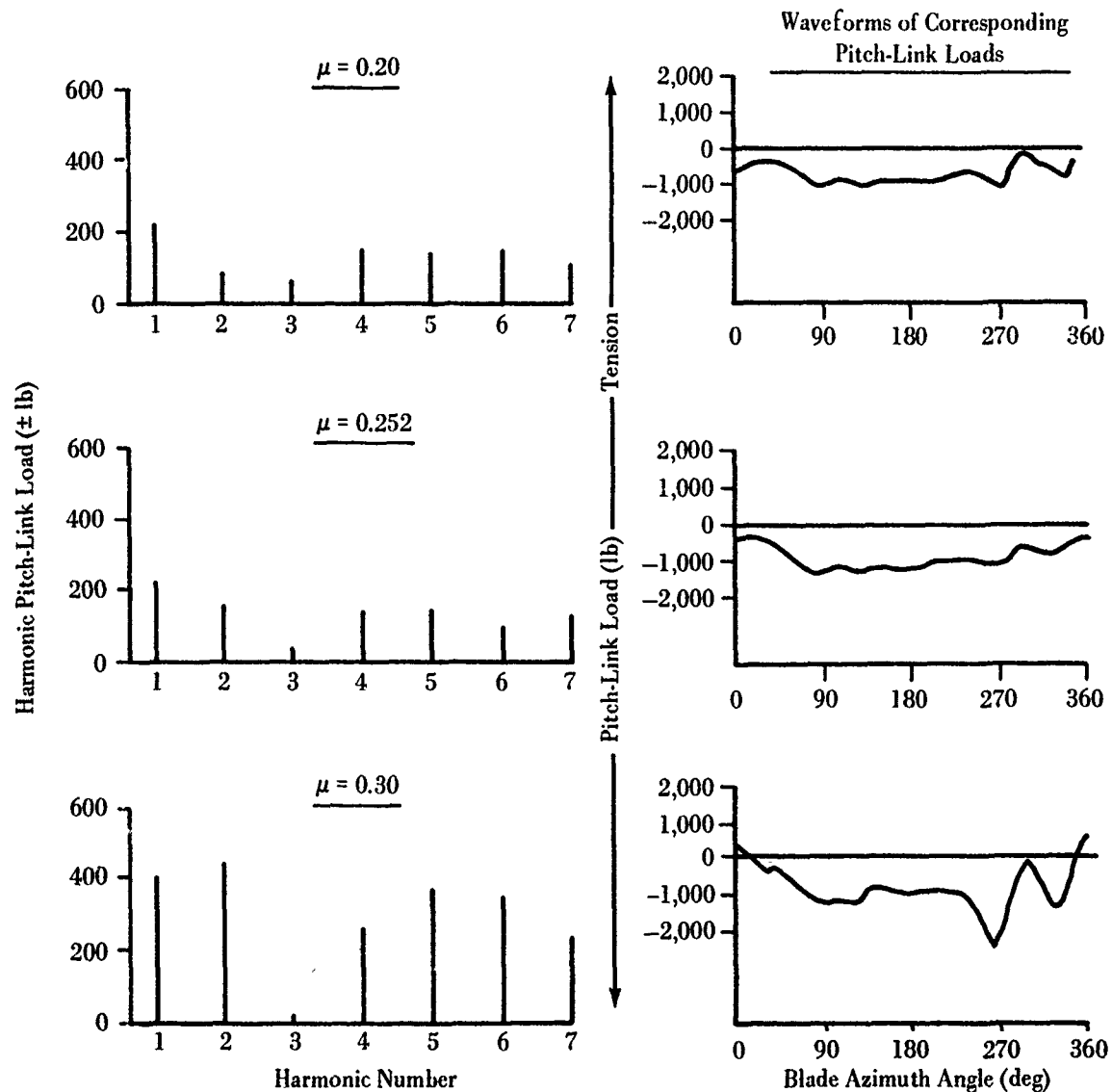

Figure 9. Stall Effects on Harmonic Pitch-Link Loads With a Damper Rate of 500 Lb-Sec/In. ($C_T/\sigma = 0.105$).

The use of harmonic analyses to understand the free-vibration portion of the stall-flutter response can be misleading, especially since the response is at the first-torsional-mode frequency of the blade-control system, and is a noninteger. The fact that this noninteger response is transient and the other blades of the rotor are just acting under forced-aerodynamic loadings ensures the passage of this loading directly to the fixed control system without significant filtering. The use of a spectral analyzer is required to identify the non-integer harmonic loads which are generated in the flutter mode.

ROTATING-SYSTEM LOADS INTO FIXED-SYSTEM LOADS

The relationship of the 5.7Ω pitch-link-load peaks, which are indicative of the stall-induced rotor loads, to the azimuthal locations of the swashplate support structures can be seen in Figure 10 for the baseline damper configuration.

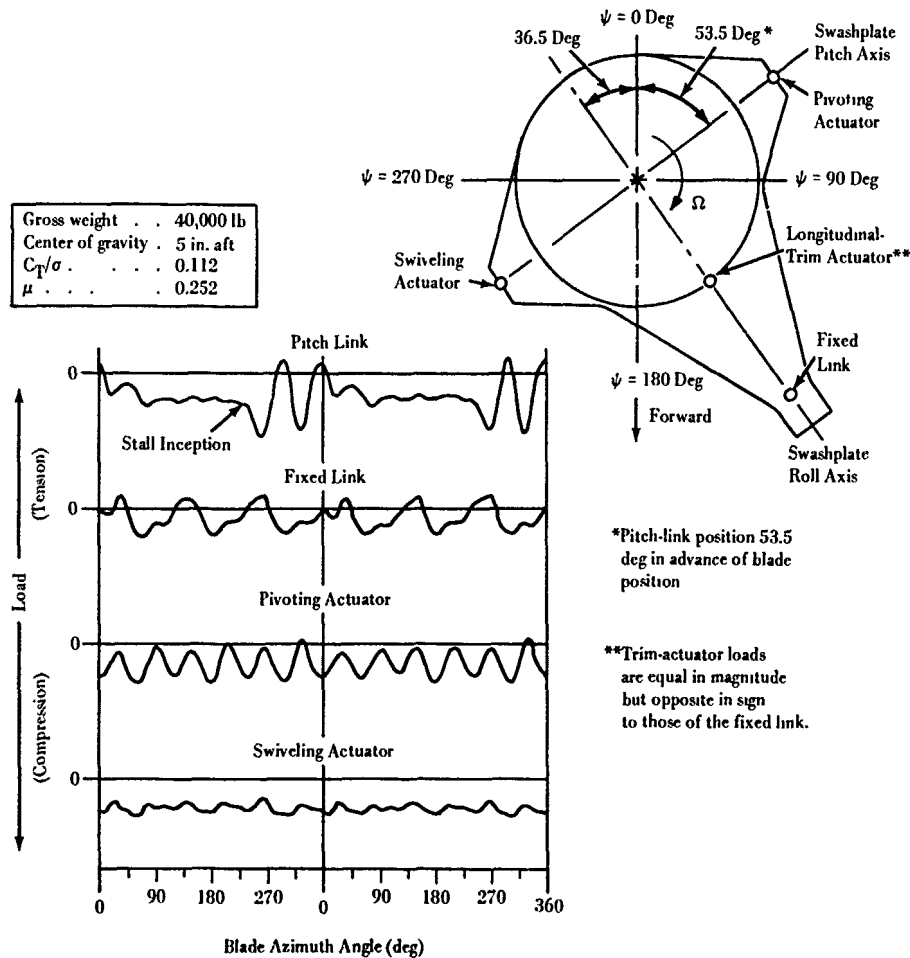

Figure 10. Stall-Induced Rotor Loads From Baseline Flight (No Damper).

The first pitch link load peak after stall inception occurs just before the arrival of the pitch link over the roll axis of the swashplate, thus producing a corresponding peak load in the fixed link and longitudinal-trim actuator. From stall inception to the first peak, the aerodynamic center moved from approximately 1/4 chord (just before stall) to the extreme aft position during the stall process. The azimuthal motion of the blade between the first and second load peaks is about 63 degrees, which is equivalent to a 5.7Ω system natural frequency. It should be kept in mind that as the blade continues to rotate, the control-system support stiffness is varying. Thus, the system frequency can be expected to vary with azimuthal position, increasing as the blade moves away from the longitudinal branch of the swashplate support.

The incorporation of the fixed-system damper into the longitudinal branch of the control system appears to have been a good choice of location, based on the load time histories in Figure 10. Since the blade first stalls at an azimuth of about 260 degrees and unstalls at about 295 degrees, the pitch link has moved from 313.5 degrees to 348.5 degrees, still quite close to the roll axis of the swashplate (pitch link leads blade by 53.5°). Thus the damper does have good access to the initial motions in the stall-flutter mode.

INCREASED DAMPING RATE REDUCES CONTROL LOADS

The effect of damper rate on the stall-induced dynamic loads in both the rotating- and fixed-control system components can be seen in Figure 11, which shows the load waveforms measured in the respective components for a rotor thrust of approximately $C_T/\sigma = 0.107$ and operating at an advance ratio of 0.25. It is quite clear that as the damping rate increases, the load amplitudes decrease. The data of Figure 11 are directly related to the data points of Figures 12, 13, and 14.

It is also clear from Figure 11 that the noninteger frequency loading (specifically that at 5.7Ω) from the pitch link is not filtered by the swashplate, and is transmitted directly to the components of the lower, fixed control system.

DAMPER-RATE EFFECTS ON PITCH-LINK LOADS

The summary plot of Figure 12 shows the effect of damper rate on the alternating (peak to peak) pitch-link loads at a rotor advance ratio of $\mu = 0.25$ for several rotor thrust conditions. It is clear that for flight at a rotor thrust of

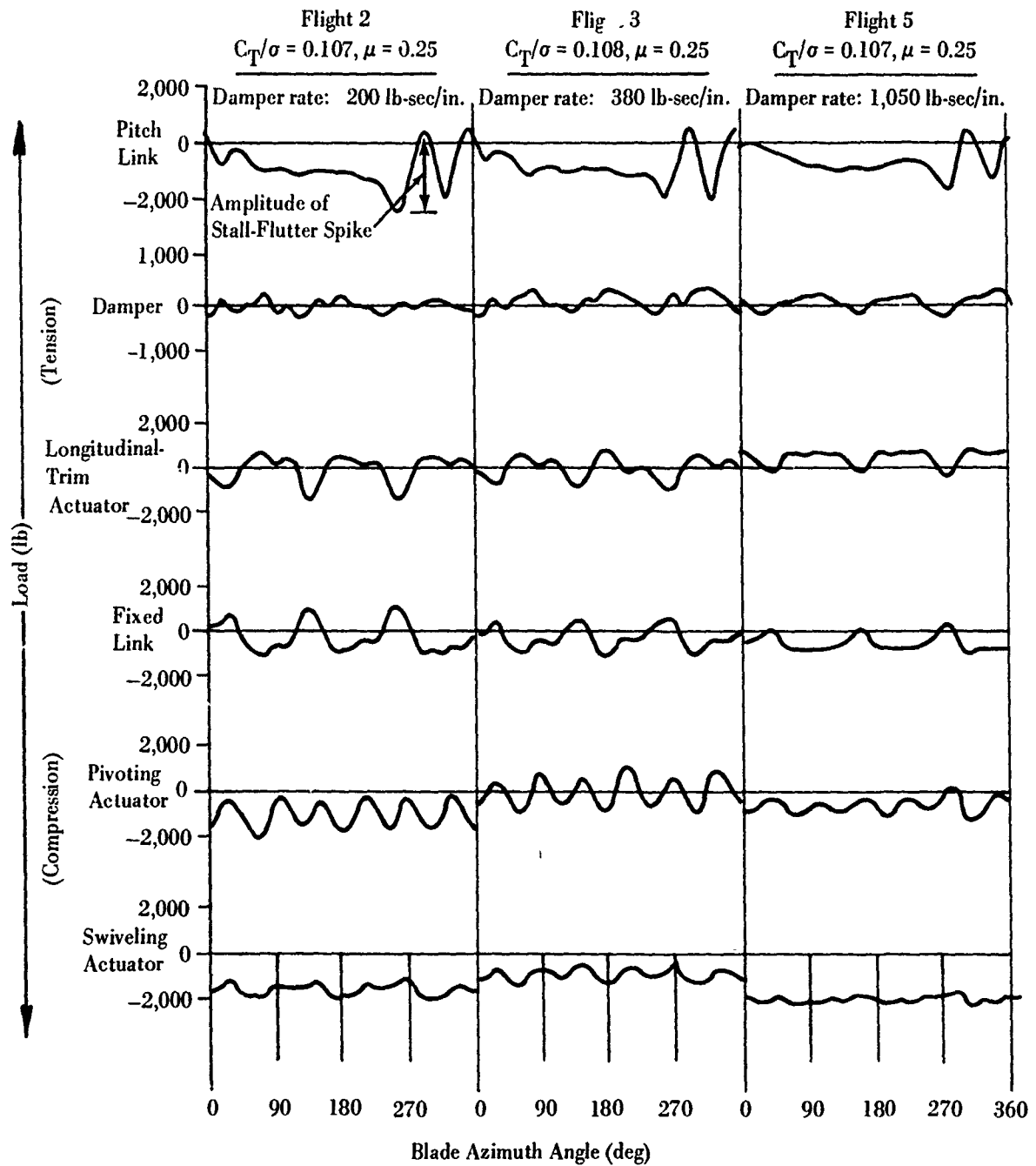

Figure 11. Aft-Rotor Control and Damper Loads for Three Damper Configurations.

$C_T/\sigma = 0.112$, the damper requirement is for a rate of greater than about 500 lb-sec/in. in order to realize a pitch link load reduction. If the damper rate is 1,050 lb-sec/in., pitch-link load reduces from $\pm 1,640$ lb to $\pm 1,390$ lb.

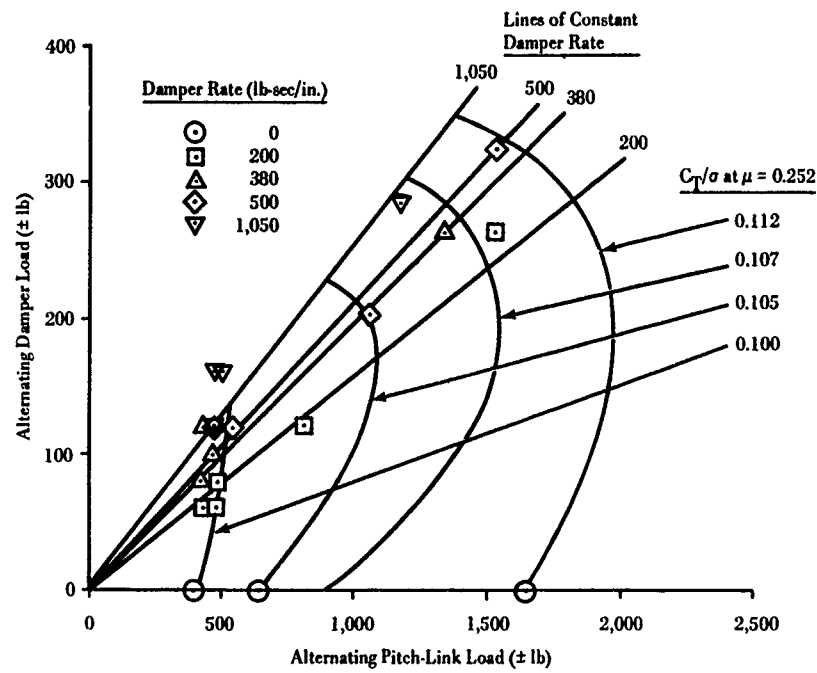

Figure 12. Alternating Pitch-Link Loads as Affected by Fixed-System Damping.

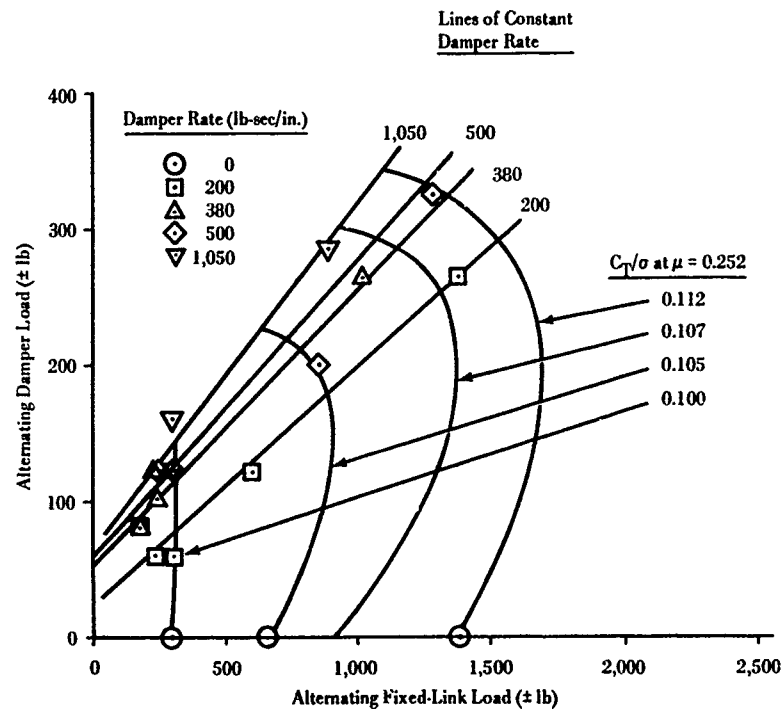

Figure 13. Alternating Fixed-Link Loads (Longitudinal Cyclic System) as Affected by Fixed-System Damping.

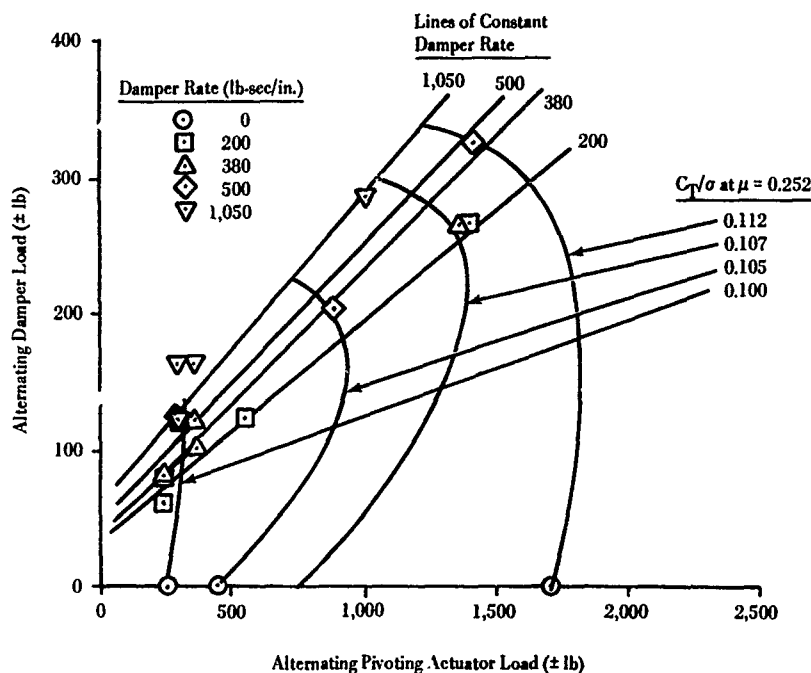

Figure 14. Alternating Pivoting-Actuator Loads (Collective and Lateral-Cyclic Systems) as Affected by Fixed-System Damping.

The effect of damping rate on pitch-link loads can be summarized as shown in Figure 15, as well as for the fixed link and pivoting actuator loads in Figures 16 and 17. Here we can see that when the rotor goes into deep stall, the effectiveness of the damper improves, primarily because of the increased motions which are experienced by the damper. In the case of $C_T/\sigma = 0.112$, the 1,050 lb-sec/in. damper reduced the alternating pitch-link loads by 16 percent. It is clear that the flutter spike has been substantially reduced. As in the case of the 500 lb-sec/in. damper configuration, the reduction was 22 percent. It should be noted that the predicted trend for the alternating pitch loads of the Model 347 analog study was substantiated during the flight-test program, even though the analog study was for one value of C_T/σ .

If there is a so-called bucket in the load-damping rate plot of Figure 15, it was not reached during this program, although the form of the curves indicates that the loads have just about reached the lowest values to be achieved for the dampers tested.

DAMPER-RATE EFFECTS ON FIXED-SYSTEM LOADS

Figures 13 and 14 illustrate the effects of the fixed-system damper rates on the principal link alternating loads,

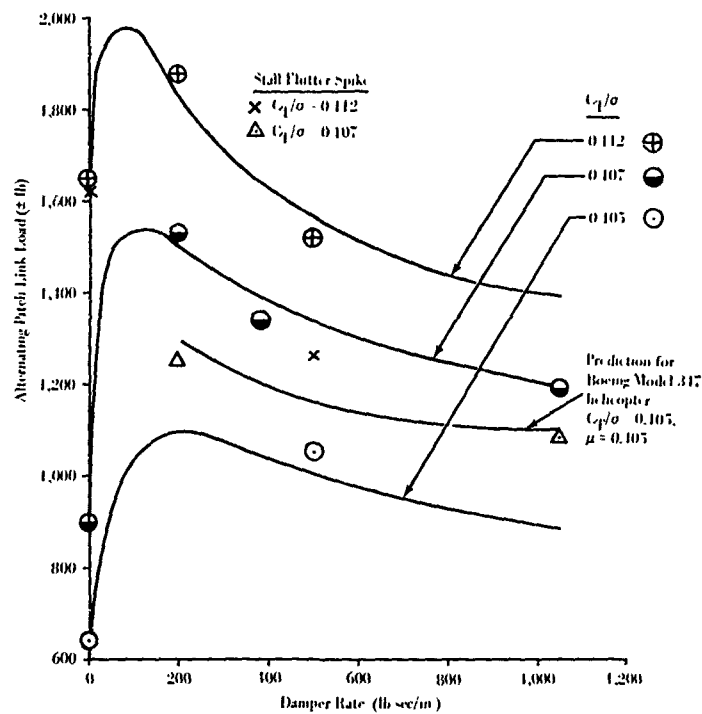

Figure 15. Pitch-Link Loads as a Function of Damper Rate ($\mu = 0.25$).

where the fixed link is representative of the longitudinal cyclic-pitch control system and the pivoting actuator which is in the lateral cyclic-control system as well as the collective control system. Referring to Figure 10, it should be noted that the pitch-link-load peak following stall occurs about 20 degrees before the arrival of the pitch link at the pivoting-actuator azimuthal location. In the case of $C_T/\sigma = 0.112$, the 1,050 lb-sec/in. damper reduced the fixed-link loads by 23 percent and the pivoting-actuator loads by 28.5 percent.

CONTROL-SYSTEM DEFLECTIONS

Harmonic analyses of the motions of the fixed-control-system components indicated that the washplate was moving as a rigid body on its support springs (actuators of both collective and cyclic control systems). They also indicate that the stall-flutter modal motions are principally in the cyclic-trim branch of the fixed control system. These findings are additional evidence (see comments relative to Figure 10) that the damper was installed in the proper azimuthal location.

MECHANICAL FREE PLAY

The steady and vibratory loads in the cyclic-trim linkage are so related that motions across the control system's

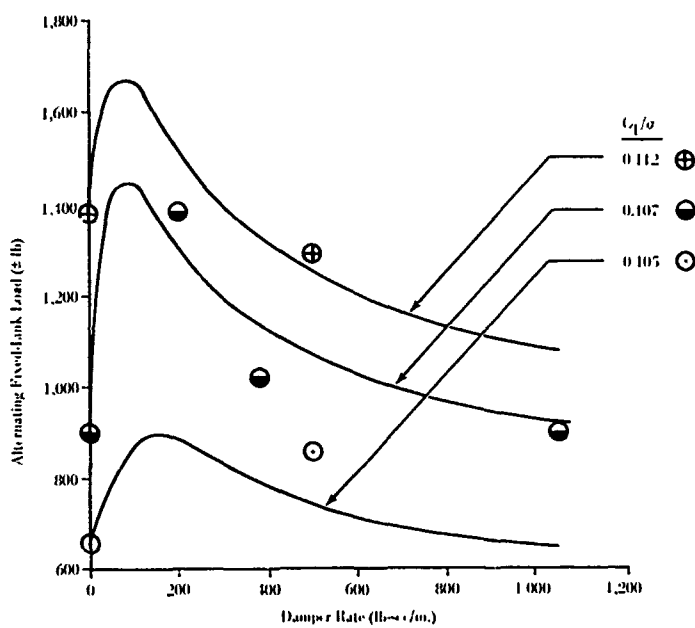

Figure 16. Fixed-Link Loads as a Function of Damper Rate ($\mu = 0.25$).

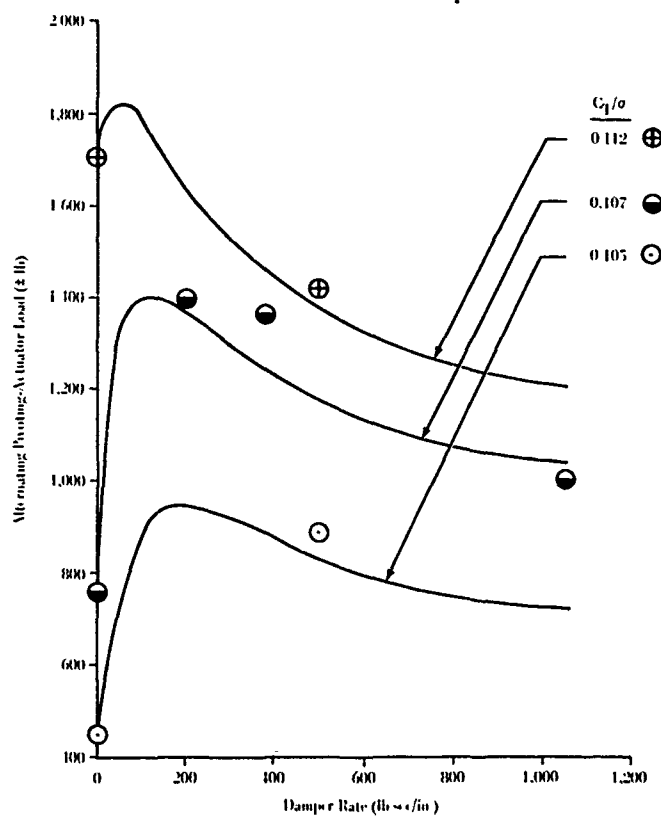

Figure 17. Pivoting-Actuator Loads as a Function of Damper Rate ($\mu = 0.25$).

mechanical free play could be a significant part of the stall-flutter motion, depending on the magnitude of the free play. Direct correlation between stall flutter response and the magnitude of the free play is difficult and can best be determined by a flight test comparison of free play versus no free play.

UNANALYZED DATA

The detailed flight-test program included flight conditions other than level flight--climb at best climb speed to altitude, obtaining data at specified altitude levels, as well as 30-degree and 40-degree banked turns at moderate and relatively high speeds. This data has not been analyzed because of the time necessary to analyze the level-flight data. This data would not change the conclusions of this report but would add to the existing large bank of data.

5. Conclusions

- A damper installed in the stationary portion of the CH-47C helicopter's aft-rotor control system can be effective in reducing stall-flutter loads in the control system.
- A damper in the fixed control system of the CH-47C helicopter has no adverse effects on blade track or stability of the control system within the range of damper rates evaluated in this program. There are no indications that increased damping would produce such effects.
- Increased damper rates reduce control loads. The maximum load reductions achieved in this program using a 1,050 lb-sec/in. damper were . . .
 - Pitch link by 16 percent
 - Longitudinal cyclic control (fixed link) by 23 percent
 - Lateral cyclic pitch and collective controls (pivoting actuator) by 28.5 percent.

- The dampers would have been more effective if the control-system deflections at the dampers had been larger. Softening of the control spring in the longitudinal branch would produce the desired effect. Care would have to be exercised so that undesirable stability characteristics are not introduced.
- The azimuthal location of the dampers was good.
- No bottom of a load-damping rate bucket was found. However, the lowest loads were, for all practical purposes, approached within the range of configurations tested.
- All basic motion modes of the rotating and nonrotating rotor-control system are involved in the stall-flutter mechanism.
- The frequency of the stall-flutter dynamic responses of the rotor is a noninteger multiple of rotational speed, and the flutter loads pass through the swashplate without significant filtering.
- The blade-control system torsional-response frequency (stall-flutter frequency) varies with azimuth angle, increasing as the blade moves away from the longitudinal branch of the swashplate support.
- The depth of stall (proportion of blade that has stalled) has a decided effect on the amplitude of the stall-flutter loads. Depth of stall is not clearly revealed in the measured component load waveforms, but it is felt that it is reliably indicated by the azimuthal location of the first peak after stall inception.
- The effect of control system mechanical free play, or lash, on the inception and degree of severity of stall flutter can be important, but cannot be assessed from the data obtained in this program.
- Spectral analyses are required to trace the stall-flutter loading and its effects throughout the control system and that harmonic analyses are inapplicable.
- Flight tests were not limited by stall-flutter loads, but by engine turbine-inlet temperature.

6. Recommendations

- A test program should be initiated in which the effects of control-system stiffness on stall-flutter responses loads could be evaluated. Previous analytical work indicates that this softening of the swashplate support will reduce the tendency to flutter. It has also been shown in this program that a reduction of stiffness will increase the effectiveness of a fixed-system damper. Thus the envisaged test program should be conducted on a CH-47C and should include the installation and flight evaluation of a variable-stiffness fixed link, in conjunction with several fixed-system-damper rates.
- The effects of control-system mechanical free play on stall-flutter response should be quantified. Free play in the control system effectively changes the impedance of that system since masses are moving through larger displacements than would result from elastic deformation of control components. Aside from the impedance effects, the free play also produces nonlinear spring effects. Even though a direct correlation between stall-flutter response and the magnitude of free play is difficult, a simple flight test of free play-no free play should be conducted on a CH-47 control system to determine if there is any measurable difference in control loads when the rotor is in the stall-flutter mode.
- A study program should be conducted which will optimize CH-47C control-system stiffness and damper combinations. Such a program should have as its goal the minimizing of stall-flutter effects on control loads.
- Based on the results of the previous recommended study program, the best-compromise control system should be defined for the CH-47C helicopter, taking into consideration the effects of changes on aircraft flying qualities. The program should cover design of hardware, strength substantiation of all rotor-control hardware as affected by redesign, and analyses to show effects of control changes on aircraft performance limits and flying qualities.
- A program should be initiated to continue the study of the data obtained in this program, with the main objective being the definition of rotor-thrust based on the measured dynamic response loads of the control system. This would permit the significance of each rotor cycle of data to be quantified. Ultimately this would mean a reduction in aircraft flight time to obtain required data, since every rotor cycle could then be considered a data point.