

AD-A022 348

VIBRATION AND TEMPERATURE SURVEY PRODUCTION
CH-47C HELICOPTER

Emmett J. Laing, et al

Army Aviation Engineering Flight Activity
Edwards Air Force Base, California

September 1975

DISTRIBUTED BY:

NTIS

National Technical Information Service
U. S. DEPARTMENT OF COMMERCE

092138

USAAEFA PROJECT NO. 70-15-6

DA022348

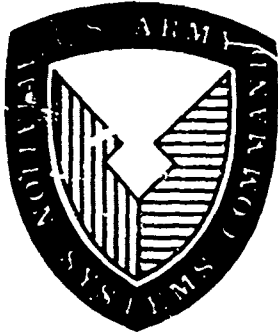

**VIBRATION AND TEMPERATURE SURVEY
PRODUCTION CH-47C HELICOPTER**

FINAL REPORT

**EMMETT J. LAING
PROJECT OFFICER/ENGINEER**

**MICHAEL A. HAWLEY
CPT, TC
US ARMY
PROJECT ENGINEER**

**RAYMOND B. SMITH
PROJECT ENGINEER**

**JAMES C. O'CONNOR
CPT, CE
US ARMY
PROJECT PILOT**

**LOUIS KRONENBERGER JR
CPT, TC
US ARMY
PROJECT PILOT**

SEPTEMBER 1975

200
MAR 29 1976
111

Approved for public release; distribution unlimited.

**UNITED STATES ARMY AVIATION ENGINEERING FLIGHT ACTIVITY
EDWARDS AIR FORCE BASE, CALIFORNIA 93523**

REPRODUCED BY
**NATIONAL TECHNICAL
INFORMATION SERVICE**
U.S. DEPARTMENT OF COMMERCE
SPRINGFIELD, VA. 22161

DISCLAIMER NOTICE

The findings of this report are not to be construed as an official Department of the Army position unless so designated by other authorized documents.

DISPOSITION INSTRUCTIONS

Destroy this report when it is no longer needed. Do not return it to the originator.

TRADE NAMES

The use of trade names in this report does not constitute an official endorsement or approval of the use of the commercial hardware and software.

A

UNCLASSIFIED

SECURITY CLASSIFICATION OF THIS PAGE (When Data Entered)

REPORT DOCUMENTATION PAGE		READ INSTRUCTIONS BEFORE COMPLETING FORM
1. REPORT NUMBER USAAEFA PROJECT NO. 70-15-6	2. GOVT ACCESSION NO.	3. RECIPIENT'S CATALOG NUMBER
4. TITLE (and Subtitle) VIBRATION AND TEMPERATURE SURVEY PRODUCTION CH-47C HELICOPTER	5. TYPE OF REPORT & PERIOD COVERED FINAL REPORT 18 July - 20 September 1974	
	6. PERFORMING ORG. REPORT NUMBER USAAEFA PROJECT NO. 70-15-6	
7. AUTHOR(s) EMMETT J. LAIN, CPT MICHAEL A. HAWLEY, RAYMOND B. SMITH, CPT JAMES C. O'CONNOR, CTP LOUIS KRONENBERGER JR	8. CONTRACT OR GRANT NUMBER(s)	
9. PERFORMING ORGANIZATION NAME AND ADDRESS US ARMY AVIATION ENGINEERING FLIGHT ACTIVITY EDWARDS AIR FORCE BASE, CALIFORNIA 93523	10. PROGRAM ELEMENT, PROJECT, TASK AREA & WORK UNIT NUMBERS 738017.A50 Q-0191 GH 3GH EJ3H004100 EJEJ	
11. CONTROLLING OFFICE NAME AND ADDRESS US ARMY AVIATION ENGINEERING FLIGHT ACTIVITY EDWARDS AIR FORCE BASE, CALIFORNIA 93523	12. REPORT DATE SEPTEMBER 1975	
	13. NUMBER OF PAGES 220 217	
14. MONITORING AGENCY NAME & ADDRESS (if different from Controlling Office)	15. SECURITY CLASS. (of this report) UNCLASSIFIED	
	15a. DECLASSIFICATION/DOWNGRADING SCHEDULE NA	
16. DISTRIBUTION STATEMENT (of this Report) Approved for public release; distribution unlimited.		
17. DISTRIBUTION STATEMENT (of the abstract entered in Block 20, if different from Report)		
18. SUPPLEMENTARY NOTES		
19. KEY WORDS (Continue on reverse side if necessary and identify by block number) Vibration and temperature measurement tests CH-47C helicopter Vibration Cabin temperature Component failure rates		
20. ABSTRACT (Continue on reverse side if necessary and identify by block number) Vibration and temperature measurement tests were conducted on a production model CH-47C helicopter to define the vibration and temperature environment for the instruments, avionics, pilot station, and selected component parts for representative flight conditions. Testing was performed by the United States Army Aviation Engineering Flight Activity at Edwards Air Force Base, California, between 18 July 1974 and 20 September 1974. The testing consisted of 16 flights totaling 19.3 productive test hours. Vibration data were recorded from		

(Continued)

UNCLASSIFIED

SECURITY CLASSIFICATION OF THIS PAGE (When Data Entered)

20. Abstract

63 accelerometer locations for 55 flight conditions and narrow band spectral analyses were performed on the vibration data. The results of the spectral analyses were summarized by use of statistical methods. Instrument and avionics vibrations were primarily low-frequency and were caused by the rotor. High-frequency instrument and avionics vibrations were also present. The highest vibration levels were recorded at the tach generators. The highest cabin temperatures were recorded under static conditions and decreased in forward flight. There were four shortcomings: amplification of vibrations at CH-47C driving frequencies by the vibration isolation mounts on the ARC-134 and ARC-54 radios, amplification of vibrations below 40 hertz by the pilot seat pad, excessive vibration levels at the pilot station in excess of the limits of military specification MIL-H-8501A, and an excessively high Wet Bulb Globe Temperature index at the pilot station under normal operating conditions.

ia

UNCLASSIFIED

SECURITY CLASSIFICATION OF THIS PAGE (When Data Entered)

PREFACE

The United States Army Air Mobility Research and Development Laboratory, Eustis Directorate, Fort Eustis, Virginia, provided data reduction, technical support through a contract with Northrop Corporation, Electronics Division, Palos Verdes Peninsula, California. The United States Army Air Mobility Research and Development Laboratory also provided instrumentation installation, calibration, and maintenance support. The dental work required to construct the pilot's bite block was provided by the Air Force Flight Test Center Dental Laboratory, Edwards Air Force Base, California. Wet Bulb Globe Temperature measurement equipment was obtained from the United States Army Medical Equipment Research and Development Laboratory, Fort Totten, New York. Technical advice on the measurement of pilot vibrations was obtained from the United States Army Aeromedical Research Laboratory, Fort Rucker, Alabama.

TABLE OF CONTENTS

	<u>Page</u>
INTRODUCTION	
Background	4
Test Objective	4
Description	6
Test Scope	5
Test Methodology	5
RESULTS AND DISCUSSION	
General	8
Vibration Data	8
Helicopter Vibration Sources	8
Data Relevancy	8
Data Presentation	8
Instrument and Avionics Vibration	14
Comparison with the Military Standard	14
Isolation Mount Characteristics	17
Pilot Station Vibrations	17
Selected Component Vibration Characteristics	20
Temperature Data	22
Component Air Temperatures	22
Wet Bulb Globe Temperature Index	24
CONCLUSIONS	
General	26
Shortcomings	26
RECOMMENDATIONS	28

Page

APPENDIXES

A. References	29
B. Aircraft Description	30
C. Test Instrumentation	37
D. Test and Data Analysis Methods	71
E. Test Data	79
F. Glossary	212

DISTRIBUTION

INTRODUCTION

BACKGROUND

1. The failure rates of helicopter components such as instruments, avionics, gearboxes, bearings, and pumps have hindered mission accomplishment and have increased the logistic support effort required to keep Army helicopters at the necessary level of operational capability. It is suspected that many component failures result from an excessive vibration and temperature environment and that the helicopter vibration and temperature environment may degrade crew performance. However, there are insufficient data available to verify these suspicions. To obtain the data necessary to define the vibration and temperature environment of helicopter components and the crew stations, the United States Army Aviation Engineering Flight Activity (USAAEFA) was directed (ref 1, app A) by the United States Army Aviation Systems Command (AVSCOM) to conduct a vibration and temperature survey on present-day Army helicopters.

2. This report on the CH-47C helicopter is the last of six reports which define the vibration and temperature environment of the OH-58A (ref 2, app A), UH-1H (ref 3), CH-54B (ref 4), OH-6A (ref 5), AH-1G (ref 6), and CH-47C helicopters.

TEST OBJECTIVE

3. The objective of the entire environmental test project was to determine quantitative vibration and temperature environment data for all present-day Army helicopters. The objective of the CH-47C environmental survey was to determine the vibration and temperature environment of the CH-47C instruments, avionics, selected components, and the crew stations under all normal operating conditions.

DESCRIPTION

4. The CH-47C helicopter is a dual-engine, turbine-powered, tandem-rotor aircraft designed to provide air transportation for cargo, troops, and weapons within the combat area. The helicopter is powered by two Lycoming T55-L-11 gas turbine engines mounted in separate nacelles on the aft fuselage. The maximum power rating (10 minute) of the T55-L-11 engine is 3750 shaft horsepower (shp). The engines are derated to 3000 shp for CH-47C installation because of transmission torque limits. The engines drive two fully articulated three-bladed rotors in tandem through a combining transmission, drive shafting, and reduction transmissions. A gas turbine auxiliary power unit is used to provide hydraulic and electrical power for engine starting and other ground operations when the rotors are not turning. The helicopter is equipped with four nonretractable landing gear. A cargo hook is provided with a maximum load capacity of 20,000 pounds. The cockpit compartment has seats and controls for the pilot and copilot. Five spring-mass

type vibration absorbers are mounted in the aircraft. Two absorbers pretuned to 243 rotor rpm are mounted in the aft pylon and three self-tuning absorbers are mounted in the forward fuselage: one in the nose and one each under the pilot and copilot seats. The cockpit instruments are rigidly mounted. Selected avionics items are mounted on vibration isolators. The avionics equipment on the test aircraft (serial number 69-17126) were as specified in the operator's manual (ref 7, app A), except for the exclusions listed in appendix B. Detailed aircraft information may be found in the operator's manual and appendix B.

TEST SCOPE

5. Vibration data were recorded during steady and maneuvering flight from 54 triaxial accelerometer locations, 8 biaxial accelerometer locations, and 1 uniaxial location for 55 flight conditions. Three configurations were tested: light, 27,600 pounds; heavy internal load, 37,900 pounds; and sling load, 38,100 pounds. The vibration absorbers were operating for all testing. The flight conditions tested are listed in table 1 and the various configurations are presented in appendix B. Temperature data were recorded at 20 locations in flight and during static hot soaks in the sun. The nose of the helicopter was pointed toward the sun for all temperature measurements. The accelerometer and thermocouple locations are described in appendix C and photographs are presented in appendix C. A total of 16 flights, consisting of 19.3 productive testing hours, were conducted at Edwards Air Force Base, California. Data were compared with vibration data previously obtained on other helicopters. The flight restrictions and operating limitations were as specified in the operator's manual. The flight conditions and configurations used for all previous helicopter environmental testing are contained in the previously published reports on each helicopter (refs 2 through 6, app A).

TEST METHODOLOGY

6. The test CH-47C helicopter was instrumented to record vibration data on a frequency multiplexed-frequency modulated (FM-FM) magnetic tape system. One hundred seventy-nine channels of acceleration vibration data were recorded from accelerometers mounted on the instrument panel, avionics, crew stations, and other selected components. The instrumentation was limited to recording data from 12 accelerometers simultaneously with 8 manual switching groups. This switching enabled a total of 96 channels of vibration data to be recorded for each flight condition. To record the total of 179 channels, the accelerometers were relocated and all flight conditions were repeated. Twenty channels of temperature data were hand-recorded from a single display by manually switching to the desired transducer. The parameters required to define the flight condition were hand-recorded from calibrated ship's standard instruments.

Table 1. CH-47C Vibration Test Conditions.¹

Test	Conditions	Average Gross Weight (lb)	Configuration	Average Density Altitude (ft)	Average Temperature (°C)
Hover	In ground effect, out of ground effect	27,600	Light	4080	27.8
		38,100	Sling load	4400	27.3
		37,900	Heavy internal load	4060	29.0
Level flight	V_H (140 KCAS) ² , $0.9V_H$, $0.8V_H$, $0.7V_H$, V_{loiter} (78 KCAS)	27,600	Light	5340	29.1
	V_H (102 KCAS), $0.9V_H$, $0.8V_H$, $0.7V_H$	38,100	Sling load	5180	28.2
	V_H (125 KCAS), $0.9V_H$, $0.8V_H$, $0.7V_H$, V_{loiter} (78 KCAS)	37,900	Heavy internal load	5220	28.3
Climb	V_{best} R/C (75 KCAS); V_{cruise} R/C (100 KCAS)	27,600	Light	6600	24.4
	V_{best} R/C (75 KCAS)	38,100	Sling load	6670	27.1
	V_{best} R/C (75 KCAS); V_{cruise} R/C (100 KCAS)	37,900	Heavy internal load	6400	25.6
Descent	V_{min} R/D (75 KCAS); V_{500} fpm R/D (105 KCAS)	27,600	Light	6600	24.4
		38,100	Sling load	6670	27.1
		37,900	Heavy internal load	6400	25.6
Takeoff	Normal (A), confined (B); from IGE hover	27,600	Light	4080	27.8
		38,100	Sling load	4400	27.3
		37,900	Heavy internal load	4060	28.0
Landing	Normal (A), steep (B); to IGE hover	27,600	Light	4080	27.8
	Normal (A); to IGE hover	38,100	Sling load	4400	27.3
	Normal (A), steep (B); to IGE hover	37,900	Heavy internal load	4060	28.0
Maneuvering flight	15° and 30° bank angle turns at V_H , constant altitude	27,600	Light	5340	29.1
		38,100	Sling load	5180	28.2
		37,900	Heavy internal load	5220	28.3
Ground run	Ground-idle (110 rpm); flight-idle (245 rpm)	27,600	Light	4080	27.8
		37,900	Heavy internal load	4060	28.0

¹Coordinated flight maintained at level flight, climb, descent, and maneuvering flight test conditions.

Rotor speed: 245 rpm.

²All abbreviations are defined in appendix F.

7. A total of 9845 vibration data records were recorded and narrow-band spectral analyses were performed on 9674 of these data records. To present the results of the spectral analysis in a form which could be more easily comprehended than the 9674 spectral analysis plots, a statistical method of summarizing the data on a digital computer (referred to as data compression) was developed. The data were compressed by selecting groups of the 9674 spectra analysis plots and summarizing each of these groups in two compressed data plots. These two compressed data plots show the maximum acceleration and the mean plus 3-standard-deviation (3-sigma) acceleration with the mean acceleration in the form of a frequency spectrum similar to the individual spectral analysis plots. The mean plus 3-sigma acceleration value is that acceleration below which 99.87 percent of all data recorded fell. Data compression was accomplished by taking the acceleration value at each of the 500 frequencies which were output by the spectral analyzer for all spectral analysis plots in a compression group and finding the maximum and minimum acceleration, the mean acceleration, and the mean plus 3-sigma acceleration. For all mean and mean plus 3-sigma compressions presented in this report, all axes are combined with no regard given to the direction of vibration. The axis is considered for the maximum acceleration compressions and a table is provided with the maximum acceleration compression plots which lists the flight condition, accelerometer location, and axis at which each maximum acceleration occurred. The equations used to calculate the mean and standard deviation and a block diagram of the spectral analysis and data compression systems are presented in appendix D.

8. The flight conditions selected for the vibration testing were selected to cover all normal flight conditions encountered in operational use of the CH-47C helicopter. The first pass of the data compression grouped the data according to flight condition. The second and third data compression passes combined all of the flight conditions in proportion to the number of columns each flight condition occupies in the data array (figs. 1 through 3, app E). For example, landings comprise 5 of 55 columns or 9.1 percent of the data which, in the compressions that combine flight conditions, represents a flight during which 9.1 percent of the flight time is spent in landings. The first-pass data compressions may be used to combine flight conditions in any proportion desired.

RESULTS AND DISCUSSION

GENERAL

9. The CH-47C instrument and avionics vibrations were primarily sinusoidal, with a random variation of amplitude with time at each discrete frequency. The primary sources of low-frequency vibration were the rotors, with a maximum mean plus 3-sigma acceleration of 0.66g at the rotor 6-per-rotor-revolution (6/rev) frequency of 24.5 hertz (Hz). High-frequency vibrations were also recorded at the instrument panel and avionics locations with a maximum mean plus 3-sigma acceleration value of 1.2g at a frequency of 1572 Hz. The amplitude limits of military specification MIL-STD-810B (ref 9, app A) were not exceeded for any test conditions, but the upper frequency limits of MIL-STD-810B were exceeded for all test conditions. Three shortcomings related to the CH-47C vibration environment were found: amplification of ARC-134 and ARC-54 rotor-induced vibrations by the avionics vibration isolation mounts; amplification of vibrations below 40 Hz by the pilot seat pad; and excessive pilot station vibrations above the limits of military specification MIL-H-8501A (ref 10). Vibrations above the rotor 1/rev frequency were attenuated by the pilot's body. The maximum mean plus 3-sigma vibration level recorded was 45g at 1572 Hz at the tach generators. The highest component temperature rise was 36.7°C above the outside air temperature at the right engine tach generator in hovering flight. The results of this test project indicate the following: Data in this and previous environmental test reports should be applied to revising the appropriate military environmental specifications; the upper frequency limit of 500 Hz of MIL-STD-810B should be extended; and improved vibration isolation for instruments and avionics should be provided.

VIBRATION DATA

Helicopter Vibration Sources

10. There are three primary sources of vibration in present-day gas turbine-powered helicopters: the main and tail rotors; all other rotating components; and, if the helicopter is armed, gunfire. The rotor-induced vibrations are of a low frequency, with the fundamental frequency equal to the rotor speed. In present-day helicopters, the main rotor speed ranges from about 3 to 8 Hz with the rotor speed generally decreasing with increasing rotor diameter. A vibration occurring at the main rotor fundamental frequency is referred to as the 1/rev. The rotor also induces harmonic vibrations at frequencies which are integral multiples of the number of rotor blades multiplied by the fundamental rotational frequency. Thus, a two-bladed rotor with a fundamental frequency of 5 Hz induces vibrations at frequencies of 5 Hz (1/rev), 10 Hz (2/rev), 20 Hz (4/rev), 30 Hz (6/rev), etc., and a three-bladed rotor at frequencies of 5 Hz (1/rev), 15 Hz (3/rev), 30 Hz (6/rev), 45 Hz (9/rev), etc. Normally, main rotor induced-vibrations beyond the 10th harmonic, 100 Hz for a two-bladed rotor, are not significant. Rotor-induced vibrations at harmonics of

the rotor fundamental frequency are the predominant helicopter low-frequency vibrations and are primarily caused by dissymmetry of lift over the rotor disc which excites rotor blade structural modes. Vibrations are induced by all other rotating components in the helicopter. The frequencies range from the fundamental rotational frequency of the component up to gear tooth, ball-bearing, and turbine-blade-passage frequencies which may range as high as 20 to 30 kilohertz. Gunfire-induced vibrations are caused by recoil forces transmitted through the gun mount and by muzzle blast pressures. They have a fundamental frequency equal to the gun rate of fire and harmonics of this fundamental up to about the 20th harmonic. Typically, the highest vibration level will be at one of the gunfire harmonic frequencies. Fundamental gunfire frequencies range up to about 70 Hz.

Data Relevancy

11. Qualitative pilot evaluation indicates that there is a wide variation in the vibration level of different helicopters of the same model due to differences in the mechanical condition of each helicopter. Thus, if vibration levels are to be measured which are representative of those encountered in a particular model of helicopter, then a sample of several units of this model of helicopter must be tested. All of the data in this report are from one CH-47C helicopter, serial number 69-17126, which began the test program with 1937 flight hours.

Data Presentation

12. The data were summarized in three data compression passes and in 8 transmissibility compressions. Each data compression is presented as two plots: maximum acceleration recorded versus frequency, and mean with mean plus 3-sigma acceleration versus frequency. The mean plus 3-sigma acceleration values best represent the test data, since accelerations in excess of the mean plus 3-sigma limit were recorded less than 0.13 percent and would be only rarely encountered in operational use of the helicopter. The data grouping used in each compression pass is summarized in table 2, with details of the data compression shown in the data arrays (figs. 1 through 3, app E). In the data array, each square represents a spectral analysis data point. The numbers assigned to each group of squares in the data array represent a compression group, with squares having like numbers belonging to the same compression group. This compression group number is written on each compressed data plot for identification. The transmissibility compressions combine all axes and flight conditions for the input and output accelerometer locations of interest. The specific locations compressed are indicated on each transmissibility plot.

13. The instrument and avionics third-pass compression results are presented in table 3 and in figures A and B in the body of this report. The second-pass compressions are presented in appendix E for all accelerometer locations. Only the instruments, avionics, and pilot station compressions are presented in appendix E for the first-pass conditions. The first-pass compressions for the other locations are available from USAAEFA. For the second and third compression passes, a table is presented with the plot of the maximum accelerations which

Table 2. Data Compression Grouping.

Compression Pass	Group ¹	Group Elements (Location Number)	Number of Group Elements	Number of Compressions
1st	Equipment	Instrument panel (1, 2, 3, 4, 5, 6, 7) Avionics (8, 9, 10, 11, 14) SAS electronics (12, 13) Pilot input (15, 16, 17, 18, 19) Pilot (20, 21) Tach generators (22, 23) Forward transmission mounts (24, 25, 26, 27) Aft transmission mounts (28, 29, 30, 31) Hanger bearings (32, 33, 34, 35, 36, 37, 38) Hydraulic actuators (39, 40, 41, 42) Gearboxes (43, 44, 45) Right alternator (46) Right engine mounts (47, 48, 49) Right engine (50, 51, 52) Hydraulic pumps (53, 54) Ramp control (55) Lights (56, 57, 58) Cargo floor (59, 60) Dzeus fastener (61) Battery compartment latch (62) Fuel drain (63)	21	147
	Flight conditions ²	Hover Level flight Climb Descent Takeoff and landing Maneuvering Ground run	7	
2nd	Equipment	Same as 1st pass	21	21
	Flight conditions	All	1	
3rd	Equipment	Instruments and avionics (1, 2, 3, 4, 5, 6, 7, 8, 9, 10, 11, 14)	1	1
	Flight conditions	All	1	

¹All axes combined for all compressions.

²Flight conditions described in detail in table 1.

Table 3. Instrument and Avionics Maximum Accelerations for Figure A.

Frequency (Hz)	Flight Condition	Configuration	Axis	Location Number	Amplitude (\pm g)	Source
12	Ldg A	Heavy	V	9	0.66	Rotor 3/rev
24	Ldg A	Sling load	H	7	1.1	Rotor 6/rev
48	V_{min} R/D	Sling load	H	6	0.99	Rotor 12/rev
124	T/O B	Sling load	V	1	1.0	Rotor drive shaft
1248	T/O B	Sling load	L	10	0.38	---
1480	V_{best} R/C	Sling load	L	8	1.3	---
1508	Hover OGE	Sling load	V	10	2.2	---
1572	LF ($0.7V_H$)	Light	V	10	2.3	Forward transmission lower stage planetary gear mesh
1640	V_{500} fpm R/D	Sling load	V	10	1.99	---
1712	LF ($0.8V_H$)	Light	V	10	0.48	---

Abbreviations are defined in appendix F.

FIG. A
COMPRESSED VIBRATION DATA MAXIMUM ACCELERATION

CH-47C USR S/N 58-17126
A/C CONFIG-COMB CLEAN SLING AND INTERNAL LOAD
COMBINED FLT CONDITIONS
INSTR. PANEL / HYDRAVICAL LOW FREQ EQUIP COMPL AXIS-SENSOR LOC 1 THROUGH 14
COMPRESSION PASS NO. 8 VIB PLOT 169

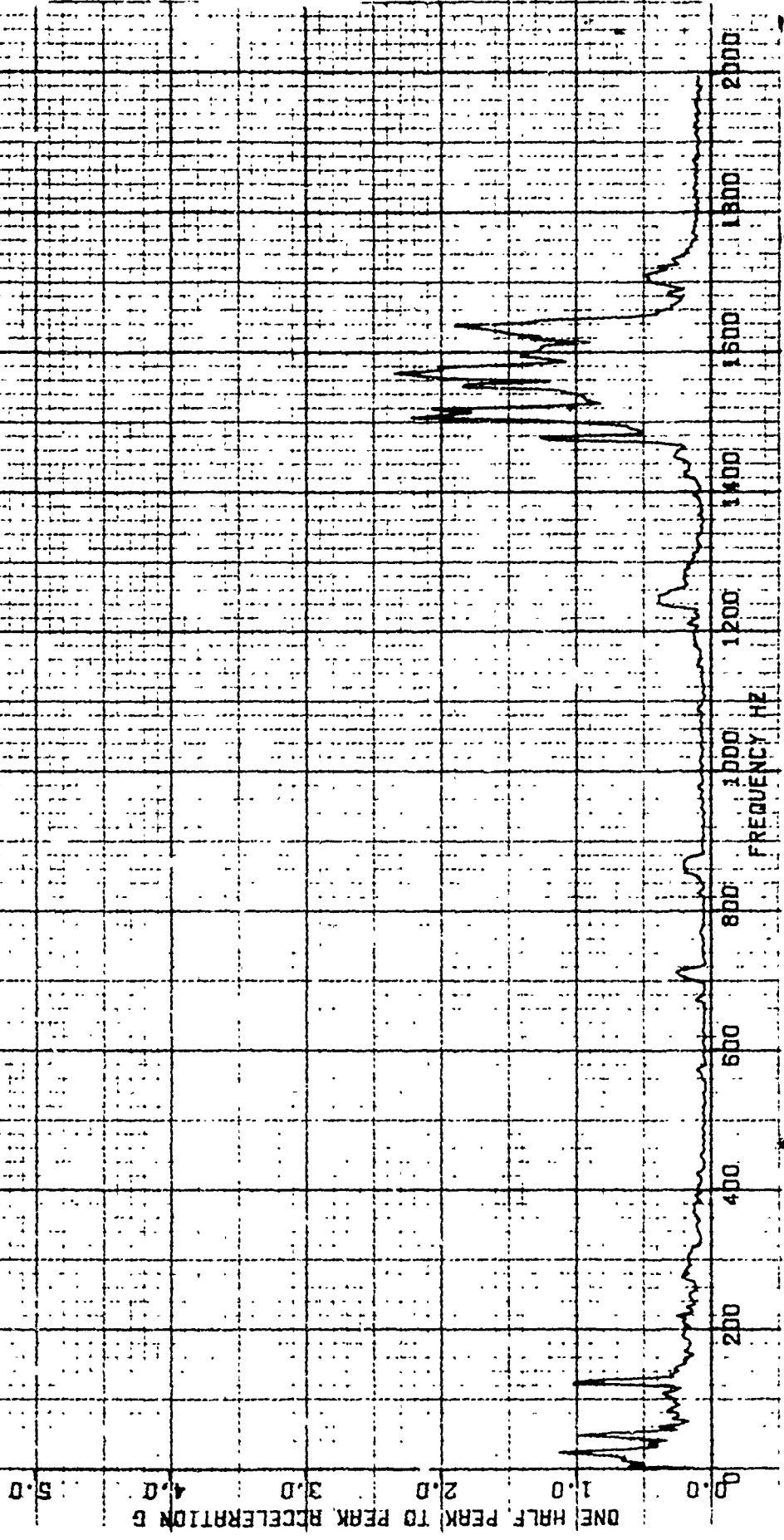

FIG 8
COMPRESSED VIBRATION DATA

CH-47C USA 8/N 69-17126
A/C CONFIG-COMB CLEAN, SLING AND INTERNAL LOAD
COMBINED FLT CONDITIONS
INSIR PANEL/AVIONICS LOW FREQ EQUIP COMB AXIS-SENSOR LOC 1 THROUGH 14
COMPRESSION PASS NO. 8 VIB PLOT 169

MEAN ACCELERATION
MEAN PLIN 8 SIGNIF UPPER ACCELERATION LIMIT

ONE HALF PEAK TO PEAK ACCELERATION G
0.0 1.0 2.0 3.0 4.0 5.0

FREQUENCY HZ
200 400 600 800 1000 1200 1400 1500 1800 2000

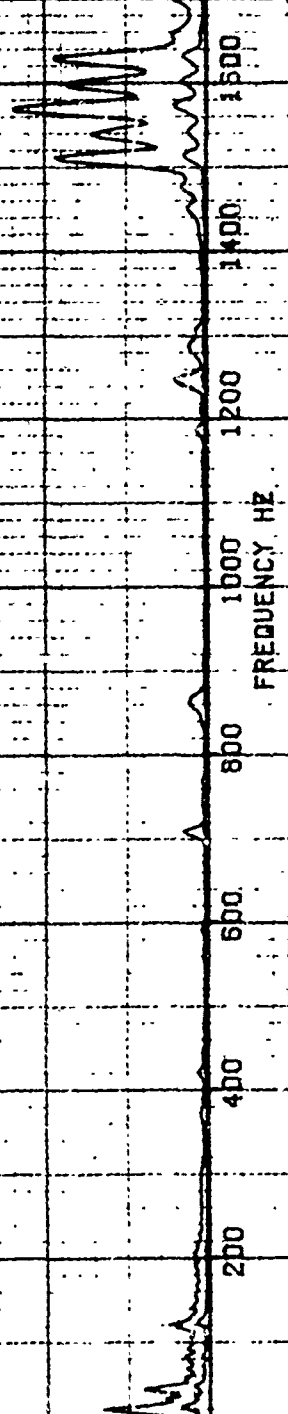

lists the accelerometer location, axis, and flight condition at which each significant peak acceleration occurred. The acceleration values which are presented in this report are one-half of the peak-to-peak value. The individual spectral analysis data, on 9-track digital computer magnetic tape, are available from USAAEFA.

Instrument and Avionics Vibration

14. Instrument and avionics vibration data were gathered from 14 triaxial accelerometer locations at the test conditions shown in table 1. Accelerometer locations and photographs are provided in appendix C. Third-pass data compressions which combine all instrument and avionics locations for all flight conditions are presented in figures A and B in the body of this report. Second-pass compressions are presented in figures 4 through 9, appendix E, and first-pass compressions are presented in figures 46 through 87.

15. The data were found to be primarily sinusoidal, with a random variation of acceleration amplitude with time at each discrete frequency. This random variation was usually less than 30 percent of the mean value and was apparently due to small changes in variables such as light turbulence or small control inputs. Table 4 lists the primary CH-47C vibration sources and their frequency at the main rotor test speed of 245 rpm. The main rotor was the primary low-frequency source. A maximum mean plus 3-sigma acceleration value of 0.66g at the main rotor 6/rev frequency of 24.5 Hz was recorded (fig. B). A peak acceleration value of 1.1g at the main rotor 6/rev frequency was recorded along the longitudinal axis at the upper right corner of the instrument panel during an approach to a hover with a sling load (fig. A). In addition to the main rotor-induced low-frequency vibrations, medium-frequency vibrations were caused by the engine and drive shafts. High-frequency vibrations were also recorded at the instrument panel and avionics locations. A maximum mean plus 3-sigma acceleration value of 1.2g was recorded at a frequency of 1572 Hz. A peak acceleration value of 2.3g at 1572 Hz was recorded along the vertical axis at the ARC-134 radio mount during level flight at 0.7V_H in the light configuration (fig. A). The forward transmission was identified as the source of these vibrations, since the vibration frequencies corresponded to the forward transmission gear mesh frequencies. These high-frequency vibrations are unlikely to cause instrument or avionics damage because of their low energy level.

Comparison with the Military Standard

16. Figure C shows a laboratory vibration test curve for equipment installed in helicopters taken from figure 514.1-3 of MIL-STD-810B. The ordinate is converted from units of vibration amplitude as the curve is presented in MIL-STD-810B, to units of acceleration to be compatible with the data presented in this report. The significant mean plus 3-sigma acceleration limits from figure B are plotted on this specification curve with previously acquired OH-58A vibration data (ref 2, app A), UH-1H vibration data (ref 3), CH-54B vibration data (ref 4), OH-6A vibration data (ref 5), and AH-1G vibration data (ref 6). This specification curve does not limit helicopter instrument and avionics vibration levels but gives vibration levels to be

Table 4. CH-47C Vibration Sources.
Main rotor speed: 245 rpm

Source		Frequency (Hz)
Main rotore	Fundamental	4.1
	3/rev	12.3
	6/rev	24.5
	9/rev	36.8
	12/rev	49.0
	15/rev	61.3
	18/rev	73.5
	21/rev	85.7
Engine shaft	Fundamental	267
Gas producer (100%)		317
Power turbine		267
Engine cross shaft		217
Main rotor drive shaft		128
N ₁ tach generator		71
NR tach generator		73
Alternator		133
Main transmission lower stage planetary gear mesh	1580	

FIGURE C

LABORATORY VIBRATION TEST CURVES FOR EQUIPMENT INSTALLED IN HELICOPTERS

FROM MIL-STD-883B, FIG 514.1-3

MEAN PLUS 3-SIGMA ACCELERATION, ALL INSTRUMENTS AND AVIONICS, ALL AXES, ALL CONDITIONS

SYMBOL	HELICOPTER
○	OH-58A
□	UH-1H
△	CH-53B
◇	OH-6A
◻	AH-1G
◼	CH-47C

NOTE: SHADED SYMBOLS DENOTE WEAPONS FIRING
 OPEN SYMBOLS DENOTE NON WEAPONS FIRING
 FLAGS DENOTE EQUIPMENT IN AFT FUSELAGE

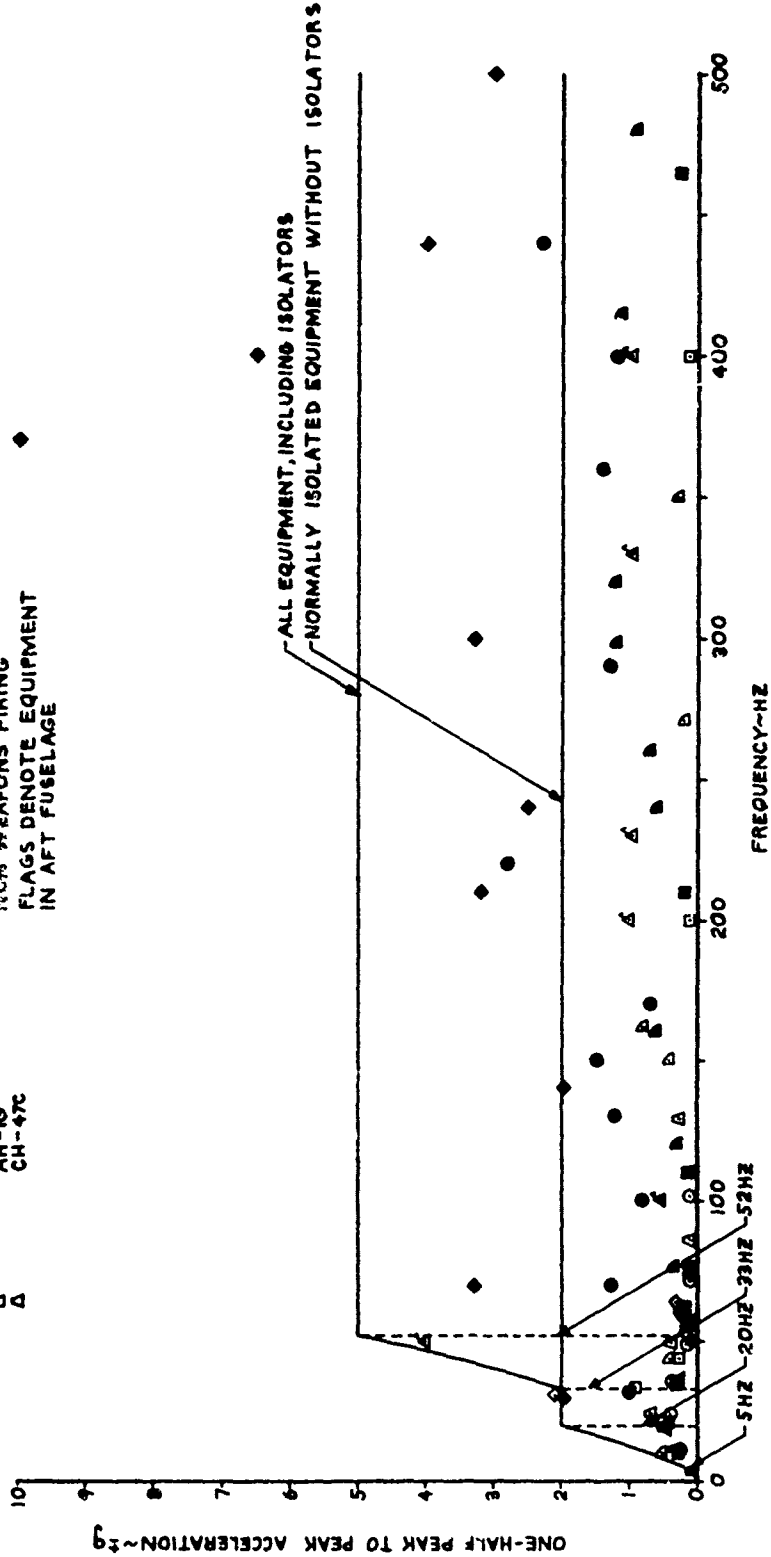

used for laboratory qualification of instruments and avionics for helicopter use. A data compression composed of only equipment mounted on isolators was not calculated, since the lower curve of figure C assumes that the vibration isolators will reduce vibrations above a frequency of 33 Hz, which was not the case for the vibration isolators tested. All CH-47C instrument and avionics mean plus 3-sigma vibration levels were well below the test curve of MIL-STD-810B. Instrument and avionics vibrations at frequencies above the MIL-STD-810B upper frequency limit of 500 Hz were recorded for all test conditions. The upper frequency limit of MIL-STD-810B should be extended to include all significant instrument and avionics vibration encountered during helicopter operation.

Isolation Mount Characteristics

17. The transmissibility of the vibration isolation mounts on the ARC-134 VHF radio and the ARC-54 FM radio was evaluated at the CH-47C driving frequencies. Transmissibility was determined by measuring the input and output accelerations across the isolation mounts and calculating the ratio of output to input acceleration. The input and output accelerations used were those determined from the average of all axes and all flight conditions. This ratio is plotted as a data point at each driving frequency in figure D. The ARC-134 isolation mounts amplified vibrations at the rotor 3/rev frequency and below. Frequencies above the rotor 3/rev were attenuated. The isolation mounts on the ARC-54 radio amplified vibrations below approximately 100 Hz. This amplification by the ARC-54 mounts is undesirable, since most of the avionics low-frequency rotor-induced vibrations are below 100 Hz. Frequencies above 100 Hz were attenuated. Amplification of vibrations at CH-47C driving frequencies by the instrument and avionics vibration isolation mounts is a shortcoming. Improved vibration isolation for instrument and avionics components should be provided.

Pilot Station Vibrations

18. Pilot station vibrations were measured at the thrust grip, cyclic grip, right pedal foot rest, seat structure, seat pad, bite block, and helmet at the conditions shown in table 1. A description and photographs of accelerometer locations are presented in appendix C. The second-pass data compressions are presented in figures 10 through 13, appendix E, and the first-pass data compressions are presented in figures 88 through 116. The pilot for which these data were recorded weighed 165 pounds and was 67 inches tall.

19. The transmissibility of the seat pad was evaluated by calculating the ratio of the seat pad acceleration to the seat structure accelerations at CH-47C driving frequencies. These ratios are plotted in figure E. Seat pad acceleration was measured by attaching an accelerometer to the bottom of a 10-inch by 6-inch by 0.020-inch aluminum plate on which the pilot sat. The accelerations used were those determined from the average of all axes for the seat pad and seat structure. Results indicate that the seat pad amplified seat structure vibrations below approximately

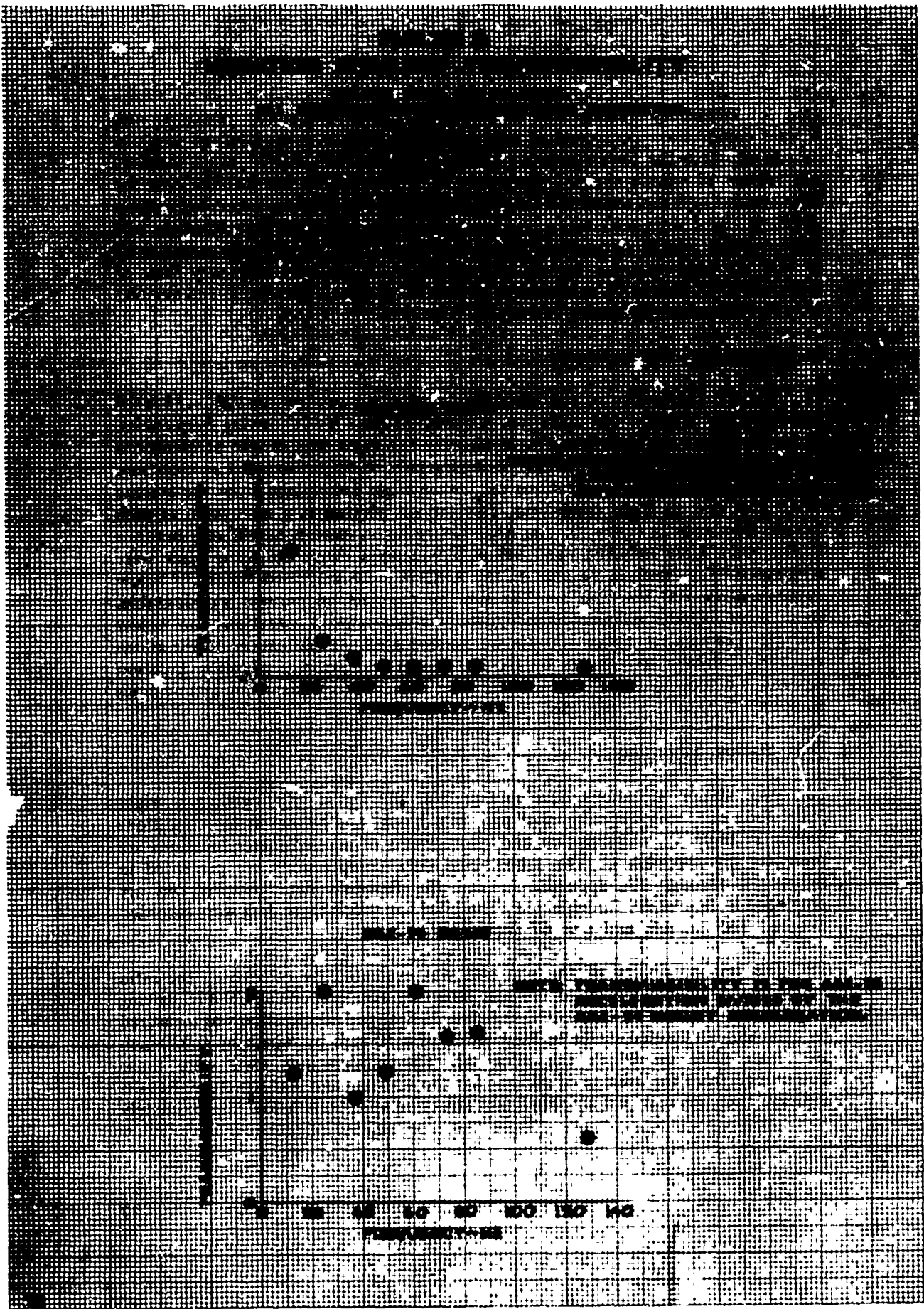

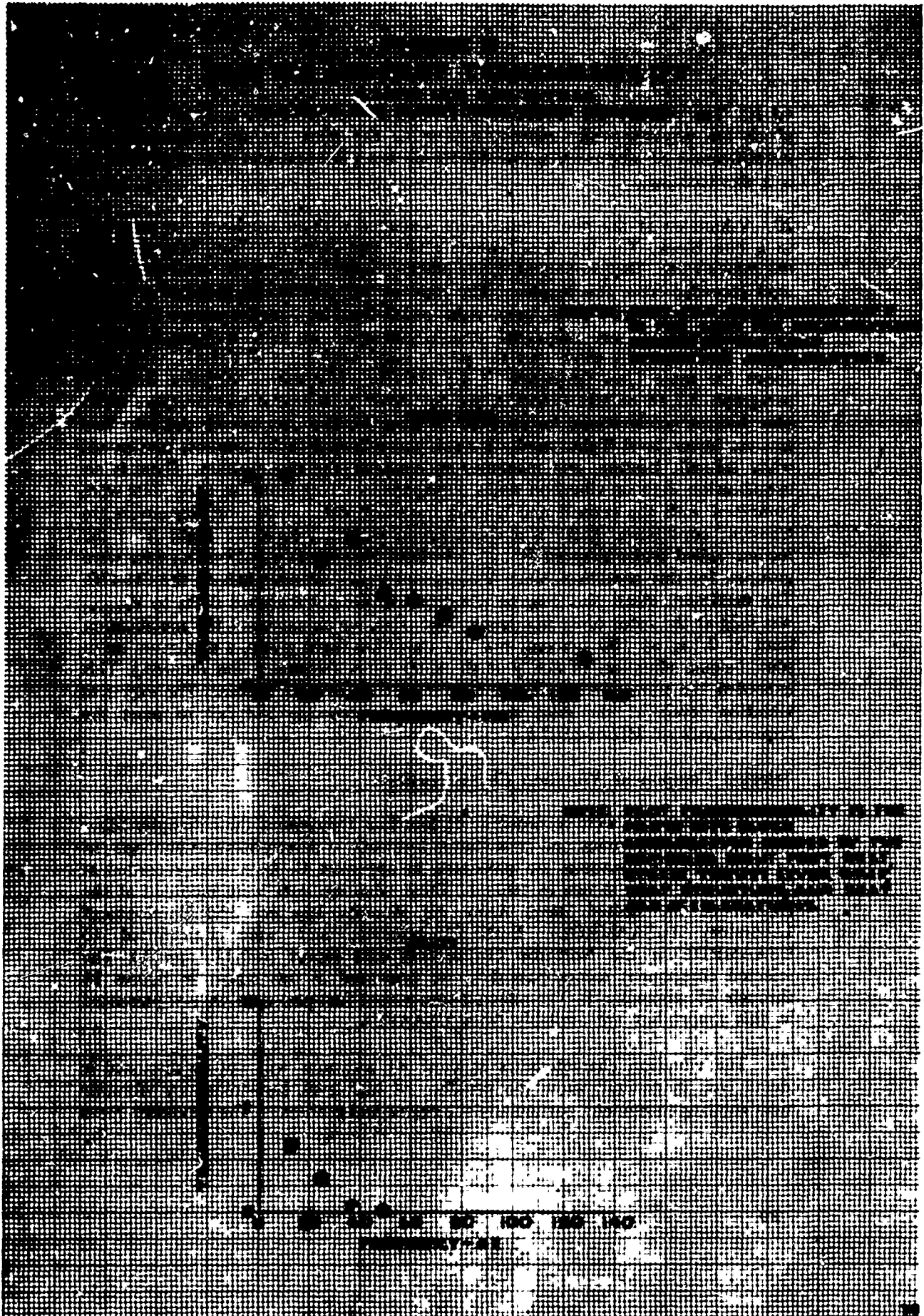

40 Hz. The primary seat structure vibrations are below 40 Hz and the vibrations which are physiologically most annoying to the pilot are also below 40 Hz. Amplification of vibrations below 40 Hz by the pilot seat pad is undesirable and is a shortcoming.

20. Vibrations at the pilot's head were measured with an accelerometer attached to a bite block. The bite block was a plastic and aluminum form shaped to fit the pilot's teeth. The pilot held the bite block securely in his mouth when vibrations were recorded from this location. The ratio of the bite block acceleration to the combined thrust grip, cyclic grip, right pedal foot rest, seat structure, and seat pad accelerations was calculated and is presented as pilot transmissibility in figure E. The results show that the pilot's body attenuates all CH-47C vibrations above the rotor 1/rev frequency of 4.1 Hz. The crew station vibration limits of paragraph 3.7.1b of MIL-H-8501A are compared to the pilot seat structure mean plus 3-sigma accelerations for all axes in figure F. The data are divided into two groups: hover, level flight, climb, descent, and sideward flight compose one group, while takeoff, landing, and maneuvering compose the other group. There is no specification limit on vibration levels during maneuvering flight, so these data were combined with the takeoff and landing transition data, since most maneuvers are transient conditions. There is a specification vibration limit for flight from the recommended cruise airspeed (V_{cruise}) to limit airspeed (V_{limit}) but no data were grouped for this condition, since V_{cruise} and V_{limit} are identical on the CH-47C. The maximum mean plus 3-sigma vibration for 30-knot rearward flight to V_{cruise} was 0.3g at the rotor 6/rev frequency (24.5 Hz), which exceeded the specification limit of 0.15g by 100 percent. For the transition flight group, a maximum mean plus 3-sigma vibration of 0.62g at the rotor 6/rev frequency was recorded. This exceeded the transition specification limit of 0.3g by 107 percent. The excessive vibration levels at the pilot station are a shortcoming and fail to meet the requirements of MIL-H-8501A.

Selected Component Vibration Characteristics

21. Vibration data were recorded at 41 locations throughout the helicopter other than instrument, avionics, and crew station locations. A description and photographs of accelerometer locations are presented in appendix C. Data were recorded at the test conditions shown in table 1. These vibration data were recorded at the request of the United States Army Air Mobility Research and Development Laboratory (USAAMRDL), Eustis Directorate, and were transmitted to USAAMRDL in the Northrop Corporation data report (ref 11, app A). The selected component second-pass data are presented in this report in figures 14 through 45, appendix E. The selected component first-pass data are not presented in this report but are available from USAAEFA.

22. The vibration characteristics at these 41 locations will not be discussed in detail but, in general, show the presence of high-level, high-frequency vibration near rotating equipment, particularly the engine and gearboxes. The maximum mean

FIGURE F
COMPARISON WITH MIL-H-8801A CREW STATION VIBRATION LIMITS

CH-47C USA S/N 68-17188
 ALL AXES COMBINED, MEAN PLUS 3-SIGMA ACCELERATION

SYMBOL

○

□

FLIGHT CONDITION

TAKEOFF-LANDING-MANEUVERING

HOVER-LEVEL FLIGHT-CLIMB-DESCENT

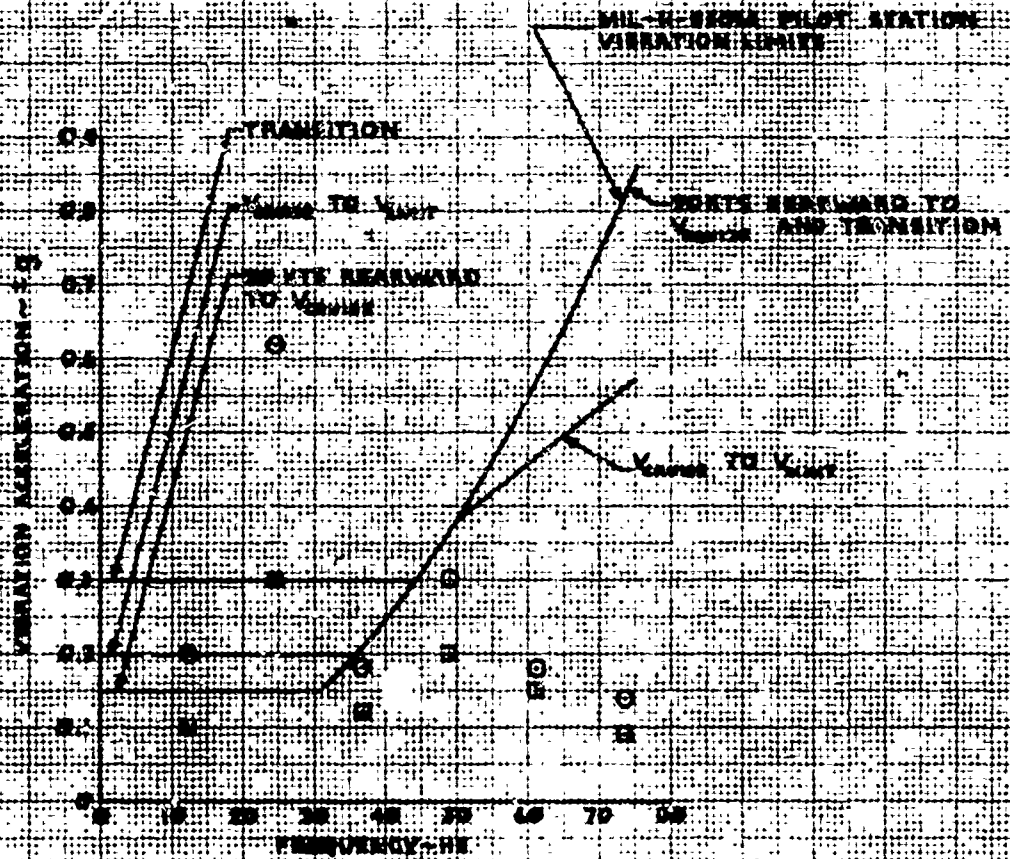

plus 3-sigma vibration acceleration level recorded was 45g at 1572 Hz at the tach generators (fig. 15, app E). The main transmission was identified as the source of these vibrations, since the vibration frequencies correspond to the main transmission gear mesh frequencies.

TEMPERATURE DATA

Component Air Temperatures

23. Component part surrounding air temperatures were recorded at 20 locations described in table 3, appendix C, and shown in photographs in appendix C. Temperatures were recorded for static hot soaks in the sun, level flight between 80 and 135 knots calibrated airspeed (KCAS), and in-ground-effect (IGE) and out-of-ground-effect (OGE) hover. The nose of the helicopter was pointed toward the sun for all temperature measurements. Temperature data for all conditions are presented in table 5. Detailed static temperature data for locations with a temperature rise of $\geq 12^{\circ}\text{C}$ or greater are presented in figures 116 through 122, appendix E. Temperature rise was determined by subtracting the outside air temperature from the component temperature of interest.

24. Solar radiation had a significant effect on both static and in-flight temperatures. In-flight data were obtained over a range of solar radiation values by recording data at different times of day from morning until afternoon. About 10 minutes were required for in-flight temperatures to stabilize at steady-state values. The in-flight temperature data presented in table 5 were obtained by averaging the temperature data over the range of solar radiation values tested. Static temperatures required about 2 hours to stabilize. This long stabilization time required that temperatures be recorded around noon when solar radiation was nearly constant for a 2-hour period. To determine static temperatures for values of solar radiation and ambient air temperature different than those tested, an analytical method was used which is described in appendix D. Figures 116 through 122, appendix E, are the results of this analytical method, with representative solar radiation values (refs 12 and 13, app A) also shown.

25. Static temperature data for the cabin and avionics locations are tabulated at a solar radiation value of 350 BTU/hr-ft^2 and outside air temperature of 45°C in table 5. These results show that the highest instrument and avionics temperatures were recorded in the forward cabin area occur under static conditions. Forward cabin temperatures decreased in flight due to increased air circulation. The high forward cabin static temperatures are due to the large windshield and window area in the forward section of the fuselage, which allows solar radiation to enter. The highest temperature rise recorded was 36.7°C at the right engine tach generator during hover.

Table 5. Average Temperature Rise.¹
CH-47C USA SN 69-17126

Location Number	Location Name	Average Temperature Rise (~°C)		
		Hover ²	Level Flight ²	Static ³
1	Instrument panel back	8.4	7.7	18.5
2	Cockpit	5.1	6.5	33.5
3	Avionics bay, upper	4.2	6.4	11.6
4	Avionics bay, lower	6.5	8.1	7.2
5	Controls closet	7.4	5.4	12.9
6	Hanger bearing No. 5	27.0	28.7	—
7	Mid cargo compartment	15.0	14.4	21.7
8	Battery compartment	9.8	11.1	11.6
9	Right electronics compartment	5.3	5.6	27.8
10	Rotor tach generator	21.4	23.1	8.2
11	Right engine tach generator	36.7	27.2	1.9
12	Right 90-degree gearbox	19.0	18.5	10.3
13	Combining gearbox	24.8	24.2	11.9
14	Aft transmission, forward compartment	23.5	14.4	11.8
15	Aft transmission, aft compartment	24.4	20.1	9.5
16	Forward transmission	8.1	10.9	21.2
17	Auxiliary power unit area (APU OFF)	3.6	3.8	10.6
18	Transmission oil cooler	1.6	2.4	11.0
19	Hanger bearing No. 1	14.5	15.3	19.0
20	Hanger bearing No. 3	27.3	27.9	—

¹Average temperature rise calculated by subtracting outside air temperature from each location temperature.

²Average solar radiation of 333 BTU/hr-ft².

³Data standardized to a solar radiation of 350 BTU/hr-ft². Outside air temperature of 45°C.

Wet Bulb Globe Temperature Index

26. The Wet Bulb Globe Temperature (WBGT) index, as described in reference 14, appendix A, was recorded in flight. A sensing unit consisting of a dry bulb thermometer, wet bulb thermometer, and black globe thermometer was located at the pilot station and exposed to the sun during this test. The sensing unit was obtained from the United States Army Medical Equipment Research and Development Laboratory, Fort Totten, New York, and is shown in photo 50, appendix C.

27. The WBGT index is used to describe the effect of the temperature environment on the human body. It is determined by adding 70 percent of the naturally convected wet bulb temperature, 20 percent of the black globe temperature, and 10 percent of the dry bulb temperature. Temperatures are measured in degrees Fahrenheit. The following criteria for application of the WBGT index are proposed in Department of the Army Technical Bulletin TB MED 175 (ref 13, app A):

a. When the WBGT index reaches 82°, discretion should be used in planning heavy exercise for unseasoned personnel.

b. When the WBGT reaches 85°, strenuous exercises, such as marching at standard cadence should be suspended for unseasoned personnel during their first three weeks of training. At this temperature training activities may be continued on a reduced scale after the second week of training.

c. Outdoor classes in the sun should be avoided when the WBGT exceeds 85°.

d. When the WBGT reaches 88°, strenuous exercise should be curtailed for all recruits and other trainees with less than 12 weeks training in hot weather. Hardened personnel, after having been acclimatized each season, can carry on limited activity at WBGT of 88° to 90° for periods not exceeding 6 hours a day.

The highest WBGT index value recorded in flight was 74.7°F at an outside air temperature of 87.8°F, a relative humidity of 15 percent, and a solar radiation value of 333 BTU/hr-ft². At an average solar radiation of 333 BTU/hr-ft², the cabin temperature was 7.2°F above the outside air temperature and the globe temperature was 9.7°F above the cabin temperature. Using these temperature differentials and a psychrometric chart (app D), the WBGT index for the CH-47C can be calculated for any combination of outside air temperatures and relative humidity at a solar radiation of 333 BTU/hr-ft². For an outside air temperature of 100°F and a relative humidity of 50 percent, the WBGT index would be 93.2°F at the pilot station. This calculation is described in appendix D. A WBGT index of 93.2°F is well in excess of the maximum discussed in the above criteria, and it is likely that a WBGT index higher than 93.2°F would be recorded under certain

conditions. Conditions of outside air temperature, relative humidity, and solar radiation higher than these will give a correspondingly higher WBGT index. An excessively high WBGT index at the pilot station is likely to be encountered during normal operation of the CH-47C helicopter and is a shortcoming.

CONCLUSIONS

GENERAL

28. Analysis of the test results obtained during this evaluation resulted in the following conclusions:

a. The CH-47C instrument and avionics vibrations were primarily sinusoidal, with a random variation of acceleration amplitude with time at each discrete frequency (para 15).

b. The primary sources of low-frequency vibrations were the rotors, with a maximum mean plus 3-sigma acceleration of 0.66g measured at the rotor 6/rev frequency of 24.8 Hz (para 15).

c. The primary sources of high-frequency vibrations were the transmission gears, with a maximum mean plus 3-sigma acceleration of 1.2g at 1572 Hz (para 15).

d. The amplitude limits of MIL-STD-810B were not exceeded for any test conditions; however, the frequency limits were exceeded for all flight conditions (para 16).

e. The pilot's body attenuated all CH-47C vibrations above the rotor 1/rev frequency of 4.1 Hz (para 20).

f. The maximum mean plus 3-sigma vibration level recorded was 45g at 1572 Hz at the tach generators (para 22).

g. The highest instrument and avionics temperatures were recorded in the cabin area under static conditions and decreased in forward flight (para 25).

h. The highest average temperature rise was 36.7°C above the outside air temperature at the right engine tach generator (para 25).

i. There were no deficiencies and four shortcomings noted during the testing.

SHORTCOMINGS

29. The following shortcomings were identified:

a. Amplification of vibrations at CH-47C driving frequencies by the ARC-134 and ARC-54 isolation mounts (para 17).

- b. Amplification of vibrations below 40 Hz by the pilot seat pad (para 19).
- c. Excessive vibration levels at the pilot station in excess of the limits of MIL-H-8501A (para 20).
- d. Excessively high WBGT index at the pilot station under normal operating conditions (para 27).

RECOMMENDATIONS

30. The shortcomings should be corrected (para 29).
31. The data in this report and previous environmental test reports should be applied to revising the appropriate military environmental specifications.
32. The upper frequency limit of 500 Hz of MIL-STD-810B should be extended (para 16).
33. Improved vibration isolation mounts for instrument and avionics components should be provided (para 17).

APPENDIX A. REFERENCES

1. Letter, AVSCOM, AMSAV-EF, 31 August 1971, subject: AVSCOM Test Request No. 70-15, Instrument Panel, Avionics Compartment and Crew Station Environmental Study.
2. Final Report, USAASTA, Project No. 70-15-1, *Instrument Panel and Avionics Compartment Environmental Survey, Production OH-58A Helicopter*, September 1972.
3. Final Report, USAASTA, Project No. 70-15-2, *Vibration and Temperature Survey, Production UH-1H Helicopter*, January 1973.
4. Final Report, USAASTA, Project No. 70-15-3, *Vibration and Temperature Survey, CH-54B Helicopter*, March 1973.
5. Final Report, USAASTA, Project No. 70-15-4, *Vibration and Temperature Survey, Production OH-6A Helicopter*, August 1973.
6. Final Report, USAAEFA, Project No. 70-15-5, *Vibration and Temperature Survey, Production AH-1G Helicopter*, March 1974.
7. Technical Manual, TM 55-1520-227-10, *Operator's Manual, Army Model CH-47B and CH-47C Helicopters*, 3 August 1973.
8. Test Plan, USAASTA, Project No. 70-15, *Helicopter Vibration and Environmental Survey*, July 1971.
9. Military Standard, MIL-STD-810B, *Environmental Test Methods*, 15 June 1967.
10. Military Specification, MIL-H-8501A, *Helicopter Flying and Ground Handling Qualities; General Requirements For*, 7 September 1961, amended 3 April 1962.
11. Test Data Reduction Report, Northrop Corporation Electronics Division, NORT-75-218, *Environmental Vibration Survey, CH-47C Helicopter-Chinook*, February 1975.
12. Publication, Institut Royale Meteorologique de Belgique, *Donnes du Rayonnement Solair a Leopoldville, Periode 1953-1962*, 1965.
13. Publication D2-90577-2, R. A. Atlas and B. N. Charles, *Summary of Solar Radiation Characteristics, Tabular Summaries*, December 1964.
14. Department of the Army Technical Bulletin, TB MED 175, *The Etiology, Prevention, Diagnosis, and Treatment of Adverse Effects of Heat*, 25 April 1969.

APPENDIX B. AIRCRAFT INFORMATION

DIMENSIONS AND DESIGN DATA

Overall Dimensions

Aircraft length (rotors turning) 99 ft
Height (over rotor blades at rest) 18 ft, 7.8 in.

Rotor Data

Number of blades 6 (3 per rotor)
Diameter 60 ft
Rotor spacing (distance between center line of rotors) 39 ft, 2 in.
Blade chord (constant) 25.25 in.
Solidity 0.067

Gear Ratios

Engine shaft to cross shaft 1.23:1
Cross shaft to rotor drive shaft 1.70:1
Rotor drive shaft to rotors 30.72:1

Operating Limitations

Engine power (10 minutes) 3750 shp or
PTIT of 840°C
Engine power (30 minutes) 3750 shp or
PTIT of 787°C
Engine power (continuous) 3300 shp or
PTIT of 748°C
Rotor speed (power ON) 232 to 250 rpm
Rotor speed (power OFF) 214 to 261 rpm
Maximum airspeed (sea level) 174 knots
Maximum gross weight 46,000 lb
Maximum fuel 7150 lb

Transmission Ratings

Dual-engine operation.
Normal and maximum 5850 shp
78 percent Q

Single-engine operation:

Maximum

3750 shp
97 percent Q

The following avionics equipment was
not installed in the test aircraft:

T366A/ARC emergency VHF command transmitter
AN/ARC-102 high-frequency radio set
TSEC KY-28 voice security equipment
YG-1054 proximity warning

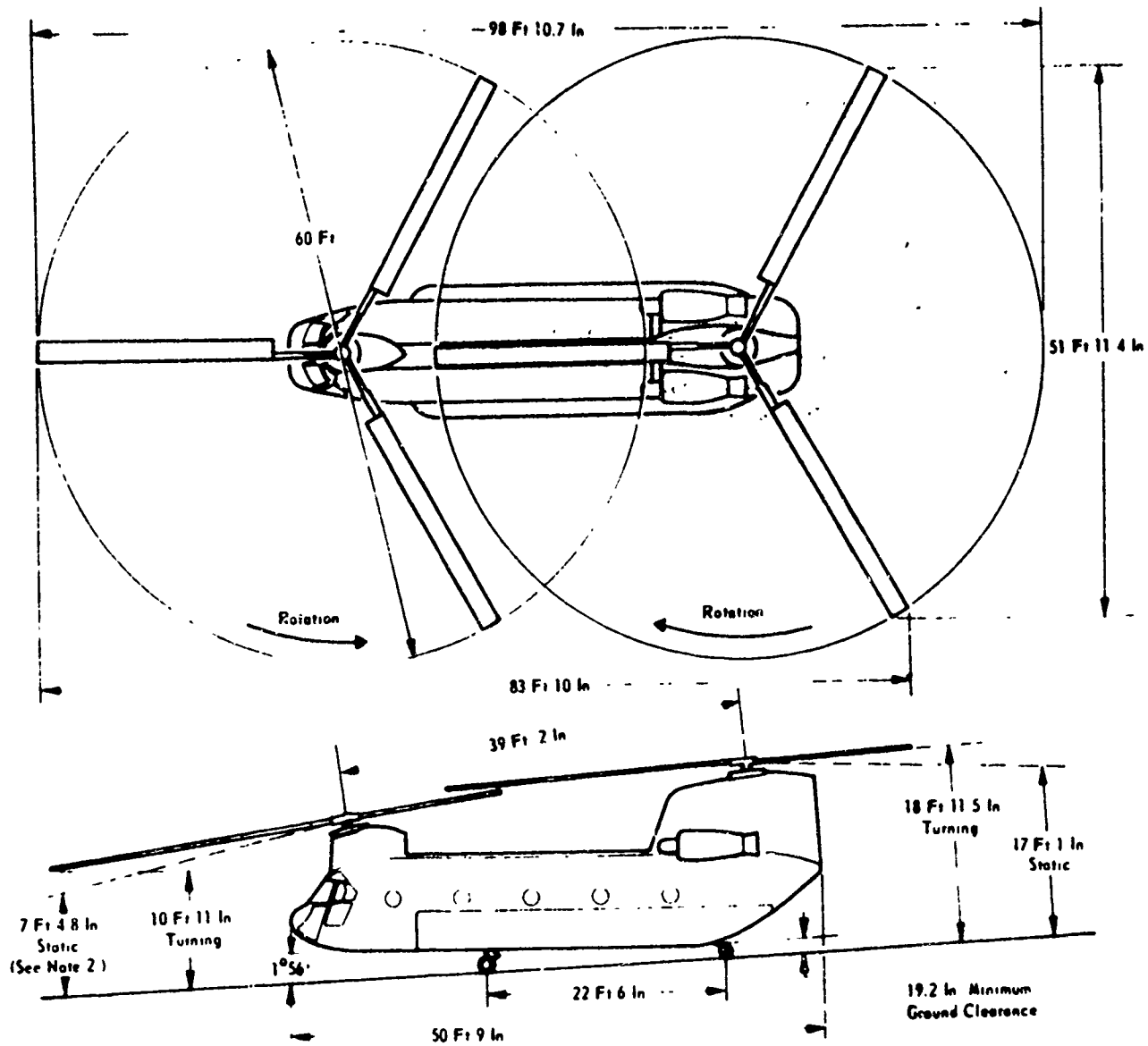
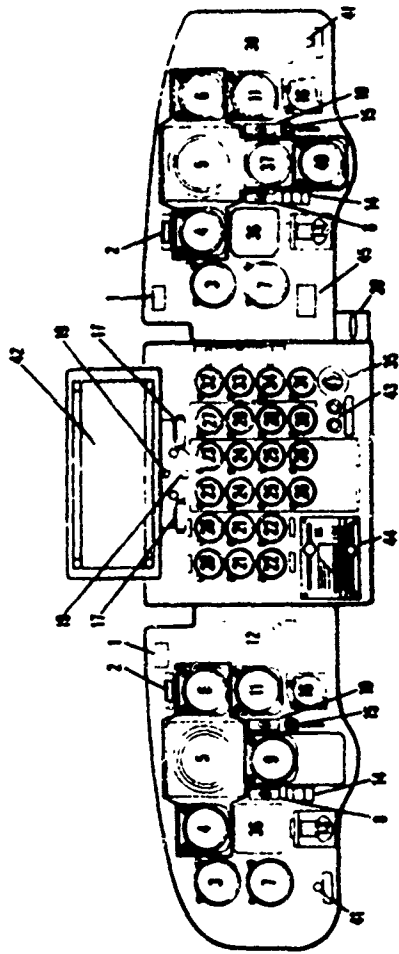

FIGURE 1. HELICOPTER DIAGRAM

FIGURE 2.
INSTRUMENT PANEL CONFIGURATION. CH-47C S/N 69-17126



- | | |
|--|--|
| <ul style="list-style-type: none"> 1. Radio call plate (2) 2. Master caution light (2) 3. Torquemeter (2) 4. Airspeed indicator (2) 5. Attitude indicator (2) 6. Altimeter (2) 7. Rotor tachometer (2) 8. Attitude indicator (VGI) switch (2) 9. Radio magnetic indicator (ID-250A/ARN) 10. Compass slaving switch (2) 11. Vertical velocity indicator (2) 12. Copilot's checklist 13. Turn-and-slip indicator (2) 14. Radio magnetic indicator plate (2) 15. Marker beacon light (2) 16. Clock (2) 17. Fire control handle (2) 18. Fire extinguisher agent switch 19. Fire detector test switch 20. Ac Loadmeters (2) 21. Dc Loadmeters (2) 22. Longitudinal cyclic trim indicators (2) 23. Gas producer tachometers (2) | <ul style="list-style-type: none"> 24. Power turbine inlet temperature indicators (2) 25. Engine oil temperature indicators (2) 26. Engine oil pressure indicators (2) 27. Transmission oil pressure indicator 28. Transmission oil pressure selector switch 29. Transmission oil temperature indicator 30. Transmission oil temperature selector switch 31. Fuel quantity indicator 32. Flight control hydraulic pressure indicator (No. 1) 33. Flight control hydraulic pressure indicator (No. 2) 34. Utility hydraulic pressure indicator 35. Fuel quantity selector switch 36. Blank panel 37. Gyrosyn compass indicator (ID-998/ASN) 38. Pilot's checklist 39. Parking brake handle 40. Course indicator (ID-1347) 41. Cockpit air knobs (2) 42. Flight log display (not installed) 43. KY-28 and IFF indicator lights 44. Vne computer 45. Interphone switch panel connection placard |
|--|--|

Table 1. Light Test Configuration.

Item	Weight (lb)	Longitudinal Fuselage Station (in.)	Longitudinal Moment (in.-lb)
Basic aircraft	21,507	345.4	7,428,800
Average fuel	5,233	316.3	1,655,000
Instrumentation	200	140.0	28,000
Pilot	165	74.5	12,293
Copilot	155	74.5	11,548
Engineer	160	104.9	16,784
Crew chief	180	180.0	32,400
Test conditions	27,600	332.8 (aft)	9,184,825

Table 2. Heavy Internal Load Configuration.

Item	Weight (lb)	Longitudinal Fuselage Station (in.)	Longitudinal Moment (in.-lb)
Basic aircraft	21,507	345.4	7,428,800
Average fuel	5,503	316.2	1,740,000
Instrumentation	200	140.0	26,000
Pilot	165	74.5	12,293
Copilot	155	74.5	11,548
Engineer	160	104.9	16,784
Crew chief	180	180.0	32,400
Ballast	1,100	175.0	192,500
Ballast	3,950	282.0	1,113,900
Ballast	4,980	405.0	2,016,900
Test conditions	37,900	332.3 (aft)	12,593,125

Table 3. Sling Load Test Configuration.

Item	Weight (lb)	Longitudinal Fuselage Station (in.)	Longitudinal Moment (in.-lb)
Basic aircraft	21,507	345.4	7,428,800
Average fuel	5,733	315.7	1,810,000
Instrumentation	200	140.0	28,000
Pilot	165	74.5	12,293
Copilot	155	74.5	11,548
Engineer	160	10 .9	16,784
Crew chief	180	180.0	32,400
Sling load (high density)	10,000	331.0	3,310,000
Test conditions	38,100	332.0 (aft)	12,649,825

APPENDIX C. TEST INSTRUMENTATION

GENERAL

1. Flight test instrumentation was installed, calibrated, and maintained by instrumentation personnel of USAAEFA and USAAMRDL. This instrumentation was used to record vibration data, temperature data, and flight condition parameters. A list of the instrumentation components is presented in table 1.

VIBRATION INSTRUMENTATION

2. An FM-FM magnetic tape system was used to record the vibration data. A block diagram of the instrumentation system is presented in figure 1. Data were recorded over a frequency range of 3 to 2000 Hz for all flight conditions. The transducers were miniature triaxial, biaxial, and uniaxial piezoelectric accelerometers which were mounted at 61 locations throughout the aircraft for a total of 179 channels of vibration data. The instrumentation was limited to recording data from 12 accelerometers simultaneously. To record more than 12 channels of data, an eight-position manual switching network was employed and each flight condition was recorded for each switch position, for a maximum data capacity of 96 channels. To obtain the total of 179 channels of vibration data, the accelerometers were relocated after completion of all test conditions and the test conditions were repeated. The maximum capacity of the instrumentation system is 96 channels without accelerometer relocation and 192 channels with one relocation. Accelerometers were bonded to the component of interest with the accelerometer axis aligned to the component axis. The mounting locations of each accelerometer are shown in photos 1 through 40. Table 2 lists the accelerometer locations, accelerometer type, and amplitude range.

3. The vibration instrumentation was calibrated to determine the amplitude sensitivity and frequency response of the total data system. A frequency sweep was performed on each accelerometer with an electrodynamic shaker. Each accelerometer was mounted back to back with a calibrated reference accelerometer and the charge sensitivity, picocoulomb/g, and frequency response of the test accelerometer determined by comparison with the reference accelerometer. The airborne data recording system was calibrated by means of a charge source. For each channel, the charge source was set to simulate a given acceleration value by reference to the accelerometer charge sensitivity determined by the shaker calibration, and the airborne data system output was recorded. The ground station was calibrated separately from the airborne system, and the two system scale factors were combined to obtain an overall data system scale factor. It is estimated that the accuracy of the total vibration measurement system, both airborne and ground units, is within ± 10 percent of the true acceleration amplitude.

Table 1. Instrumentation Component Description

Nomenclature	Manufacturer	Quantity	Model Number
Piezoelectric accelerometer (triaxial)	Endevco	31	2228C
Piezoelectric accelerometer (uniaxial)	Endevco	3	2226C
Line driver	MB Electronics	89	9402216
Amplifier	MB Electronics	12	N400
Switching relays	Potter and Brumfield	24	JDT27DD1
FM rack	Electro Mechanical Research	2	---
FM rack voltage code oscillator (VCO)	Electro Mechanical Research	12	307A-02
FM rack mixing amplifier	Electro Mechanical Research	2	311A-02-1
FM rack reference oscillator	Electro Mechanical Research	2	313A-01
Tape recorder	Ampex Corporation	1	10-286
Time code generator	Electro Mechanical Research	1	CL24D-27.6A
Thermocouple switch (24 channels)	Thermo Electric	1	33113
Thermocouple indicator	Newport Laboratories	1	2600
Thermocouple wire (iron-constantan)	Series J	---	---
Thermal radiometer	Teledyne Geotech	1	TCH-188-01

FIGURE 1
AIRBORNE DATA SYSTEM

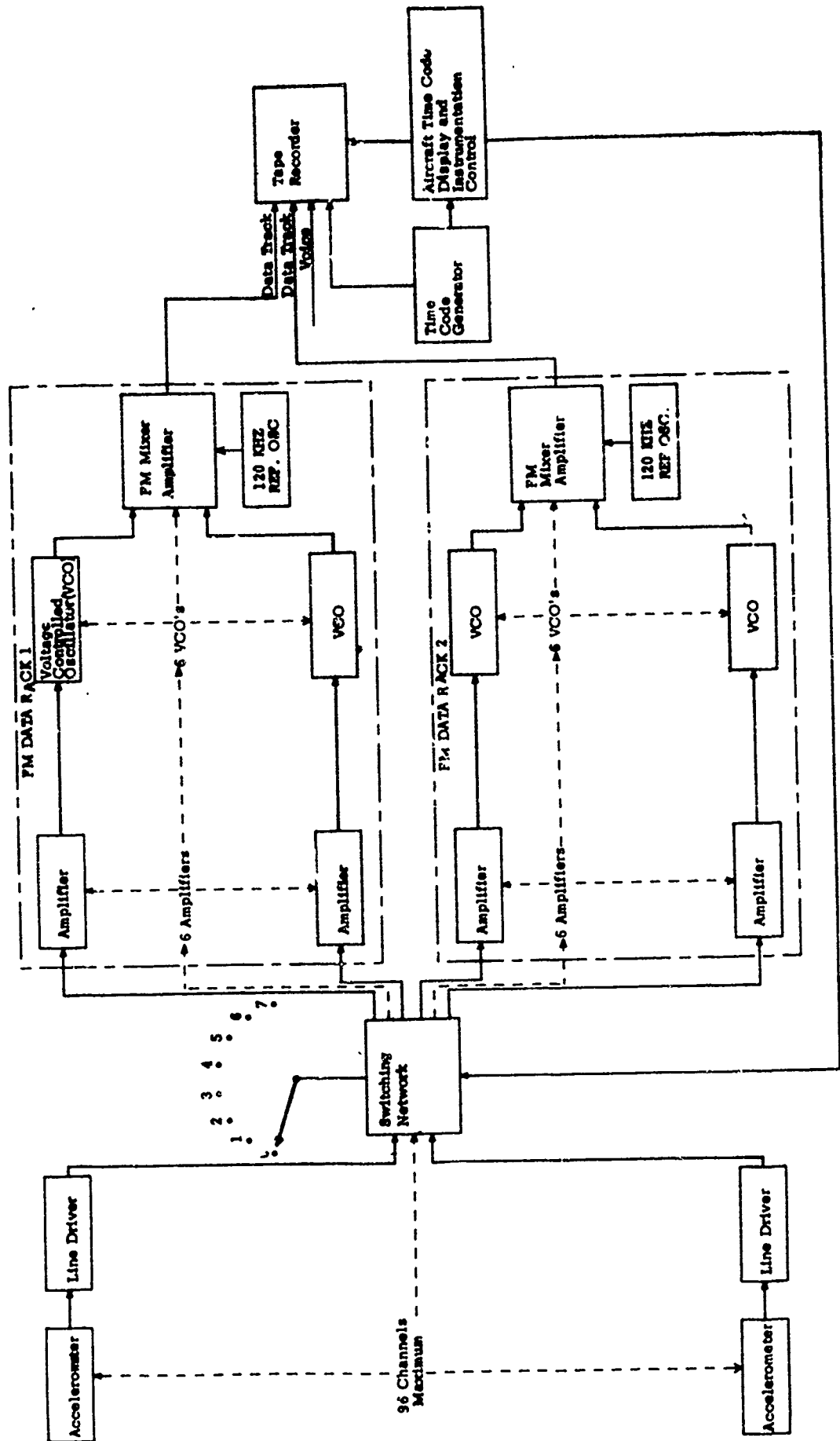

Table 2. Accelerometer Locations.¹

Location	Location Number	Fuselage Station (in.)	Water Line (in.)	Buttline (in.)	Axis	Full-Scale Acceleration Range (\pm g)
Instrument panel	1	48.3	6.6	L 29.8	3	5
	2	47.9	7.9	L 16.4	3	5
	3	48.3	6.6	L 5.1	3	5
	4	47.7	8.9	R 5.5	3	5
	5	48.3	6.6	R 17.3	3	5
	6	49.7	2.2	R 21.5	3	5
	7	47.7	8.9	R 29.8	3	5
Avionics						
ARC-54 mount	8	115.6	-7.2	L 39.0	3	5
ARC-54 radio	9	115.6	-6.4	L 39.0	3	5
ARC-134 mount	10	115.6	-7.2	L 31.9	3	5
ARC-134 radio	11	115.6	-6.4	L 31.9	3	5
Attitude gyro	12	111.4	5.5	L 15.8	3	5
SAS box	13	118.2	19.0	L 22.2	3	5
Transponder controls	14	70.3	-8.1	L 2.34	3	5
Pilot						
Seat pad plate	15	75.7	-7.7	R 22.4	3	5
Seat structure	16	73.7	-12.8	R 22.4	3	5
Pilot foot rest	17	46.2	-14.9	R 29.8	2	5
Thrust control grip	18	65.2	-1.1	R 12.6	1	5
Cyclic grip	19	60.7	0	R 22.2	3	5
Pilot helmet (SPH-4)	20	—	—	—	3	2
Micro block	21	—	—	—	3	2
Rotor tach generator	22	101.2	46.4	R 0.85	3	50
Right engine tach generator	23	492.4	60.3	R 59.0	3	50
Forward transmission mounts						
Forward	24	83.3	46.4	0	3	10
Left	25	94.1	49.6	L 17.9	3	10
Right	26	112.4	53.2	0	3	25
Aft	27	94.1	49.6	L 17.9	3	10
Aft transmission mounts						
Right forward	28	546	49.0	R 10.2	3	25
Left forward	29	548	49.0	L 10.2	3	25
Left aft	30	571	49.0	L 10.2	3	17
Right aft	31	571	49.0	R 10.2	3	17
Drive shaft hanger bearings						
No. 1	32	157.8	56.9	0	2	50
No. 2	33	207.9	56.9	0	2	50
No. 3	34	258.3	56.9	0	2	50
No. 4	35	310.0	56.9	0	2	50
No. 5	36	359.9	56.9	0	2	50
No. 6	37	408.4	56.9	0	2	50
No. 7	38	504.1	56.9	0	2	50
Control closet SAS actuator	39	106.9	24.7	L 19.6	3	5
Control closet lower boost actuator	40	111.2	12.4	L 19.6		17
Forward transmission swashplate actuator	41	76.7	58.6	L 11.3	3	75
Aft transmission swashplate actuator	42	562.3	115.0	L 14.9	3	17
Engine 90-degree gearbox	43	465.6	57.1	R 39.8	3	17
Combining gearbox input	44	461.9	65.2	R 8.5	3	17
Combining gearbox	45	465.1	69.2	0	3	50
Right alternator	46	583.6	56.7	R 6.2	3	17
Right engine						
Right mount	47	480.5	66.0	R 61.1	3	50
Left mount	48	483.0	56.9	R 35.4	3	17
Aft mount	49	501.1	53.7	R 60.7	3	17
Forward	50	483.7	69.0	R 39.8	3	17
Mid	51	500.9	77.1	R 49.0	3	75
Aft	52	515.6	75.4	R 48.6	3	17
APU hydraulic pump	53	592.9	48.6	0	3	17
Aft transmission hydraulic motor	54	580.1	49.8	0	3	17
Ramp control	55	497.5	-13.0	R 41.5	3	5
Aft pylon anticollision light	56	588.0	114.4	0	3	50
Belly anticollision light	57	296.8	-42.6	0	3	5
Formation light	58	193.2	64.1	0	3	50
Forward cargo floor	59	163.1	-29.8	0	3	5
Aft cargo floor	60	362.0	-29.8	0	3	5
Debus fastener	61	471.3	63.0	R 34.7	3	50
Battery compartment latch	62	177.0	-19.2	L 50.1	3	5
Fuel drain	63	261.8	-54.5	L 57.5	3	10

¹All accelerometers are Endevco triaxial accelerometers, Type 2228C.

TEMPERATURE INSTRUMENTATION

4. Temperature data were recorded by mounting thermocouples at 20 locations throughout the helicopter. The temperatures were displayed on one temperature indicator which was switched to the desired thermocouple. Table 3 lists the locations of the thermocouples and the temperature measurement equipment is described in table 1. Thermocouple location photographs are presented in appendix C. Solar radiation was recorded on the ground with a calibrated radiometer. Outside air temperature was recorded with a laboratory thermometer for static temperature measurements and with the ship's outside air temperature indicator for in-flight temperature measurement.

FLIGHT CONDITION PARAMETERS

5. The parameters listed in table 4 were hand-recorded from the ship's standard instruments to determine the flight condition. The readability for each instrument listed in table 4 was determined by dividing the smallest increment marked on the dial by 5.

Table 3. Thermocouple Locations.

Location	Loca- Number	Fuselage Station (in.)	Water Line. (in.)	Bu st line (in.)
Instrument panel back	1	43.0	5.3	0
Cockpit	2	75.8	46.9	0
Avionics bay, upper	3	106.3	5.3	L 36.0
Avionics bay, lower	4	110.3	-22.2	L 36.0
Controls closet	5	105.4	14.1	L 19.6
Hanger bearing No. 5	6	79.9	57.3	0
Mid cargo compartment	7	380.3	46.6	0
Battery compartment	8	175.9	-12.4	L 57.1
Right electronics compartment	9	175.9	-12.4	R 62.4
Rotor tach generator	10	101.2	46.6	L 1.06
Right engine tach generator	11	492.0	60.1	R 62.2
Right 90-degree gearbox	12	465.8	57.1	R 39.4
Combining gearbox	13	457.9	69.9	0
Aft transmission, forward	14	541.8	66.9	0
Aft transmission, aft	15	585.0	63.9	0
Forward transmission	16	130.6	85.2	0
APU area	17	607.6	57.5	0
Transmission oil cooler	18	178.8	114.2	0
Hanger bearing No. 1	19	157.8	57.3	0
Hanger bearing No. 3	20	258.3	57.3	0

Table 4. Flight Condition Parameters.

Parameter	Range of Interest	Readability
Airspeed	25 to 180 knots	±1.0 knot
Altitude	Zero to 10,000 feet	±4.0 feet
Outside air temperature	Zero to 30°C	±0.4°C
Main rotor speed	230 to 250 rpm	±2.0 rpm
Gas producer speed	60 to 110 percent	±0.2 percent
Fuel quantity	Zero to 7000 pounds	± 10 pounds

INSTRUMENTATION PHOTOGRAPHS

INDEX

<u>Accelerometer Location Number</u>	<u>Photograph Number</u>
1, 2, 3	1
4, 5, 6, 7	2
8, 9, 10, 11	3
12	4
13	5
14, 18	6
15, 16	7
17	8
19	9
20, 21	10
22	11
23	12
24, 25, 26, 27	13
28, 29, 30, 31	14
33, 34, 35, 36, 37, 38	15
39	16
40	17
41	18
42	19
43	20
44	21
45	22
46	23
47	24
48	25
49	26
50	27
51	28
52	29
53	30
54	31
55	32
56	33
57	34
58	35
59	36
60	37
61	38
62	39
63	40

Thermocouple Location
Number

Photograph
Number

1	2
2	41
3	4
4	42
5	17
6, 19, 20	15
7	43
8	44
9	45
10	11
11	12
12	20
13	22
14	46
15	31
16	47
17	48
18	49
Wet Bulb Globe Temperature sensor	50

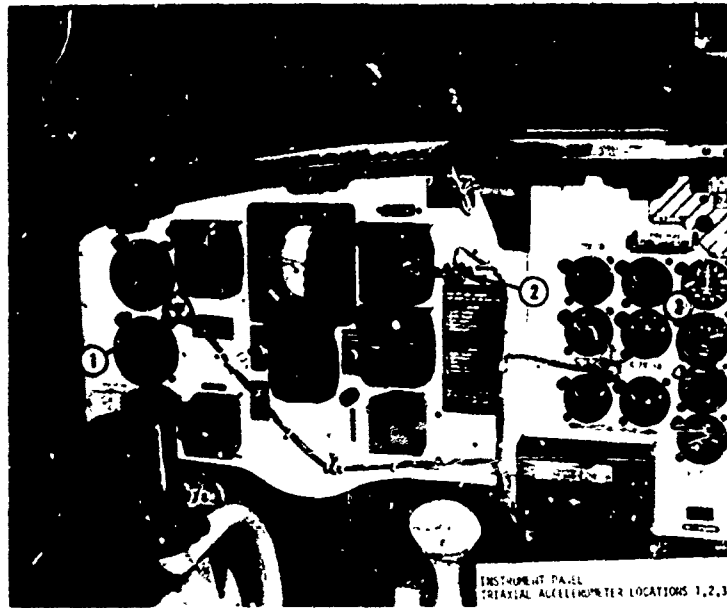

Photo 1.

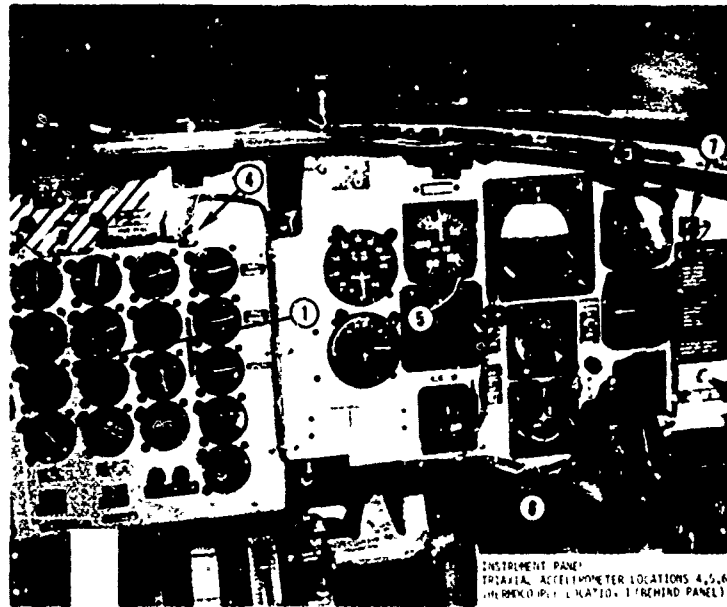

Photo 2.

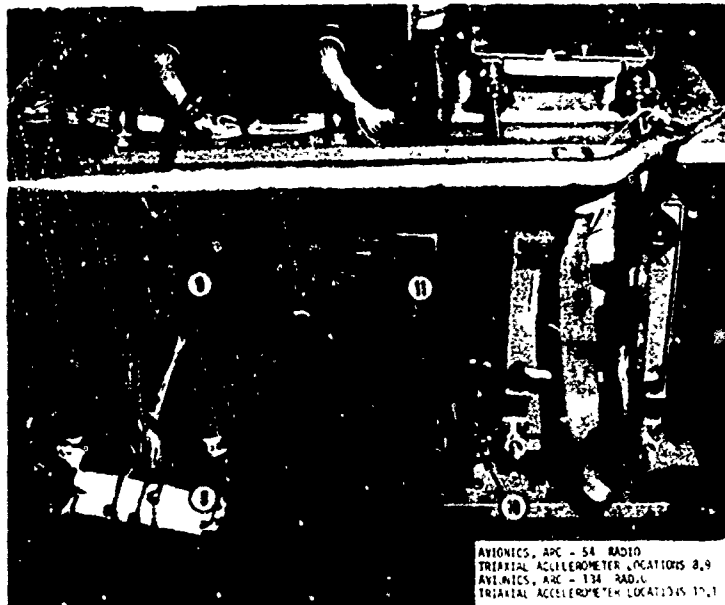

Photo 3.

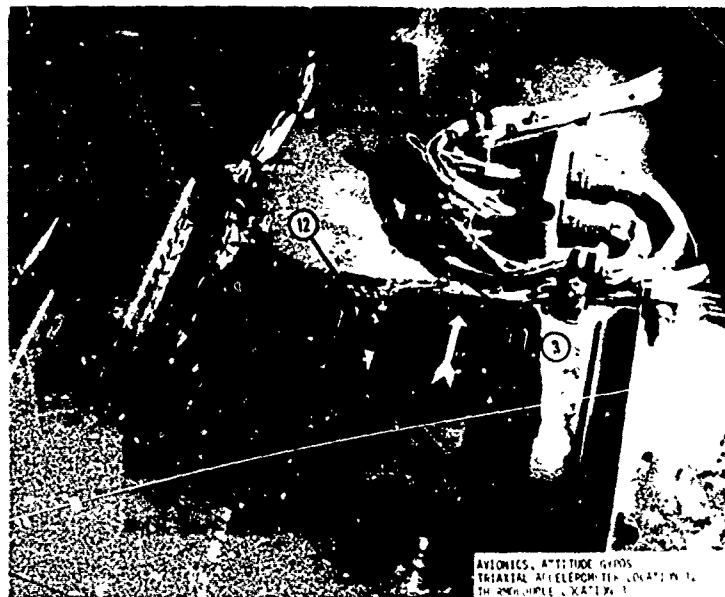
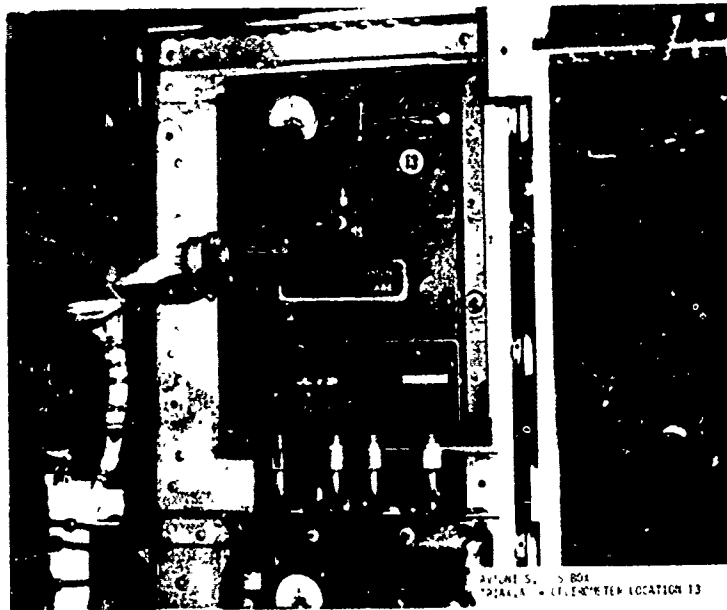

Photo 4.



AVIONICS BAY
PIKALIA - TELETYPE LOCATION 13

Photo 5.



AVIONICS TRANSFER CONTROL PANEL
PIKALIA - TELETYPE LOCATION 13
PILOT DATA CONTROL UNIT
PIKALIA - TELETYPE LOCATION 13

Photo 6.

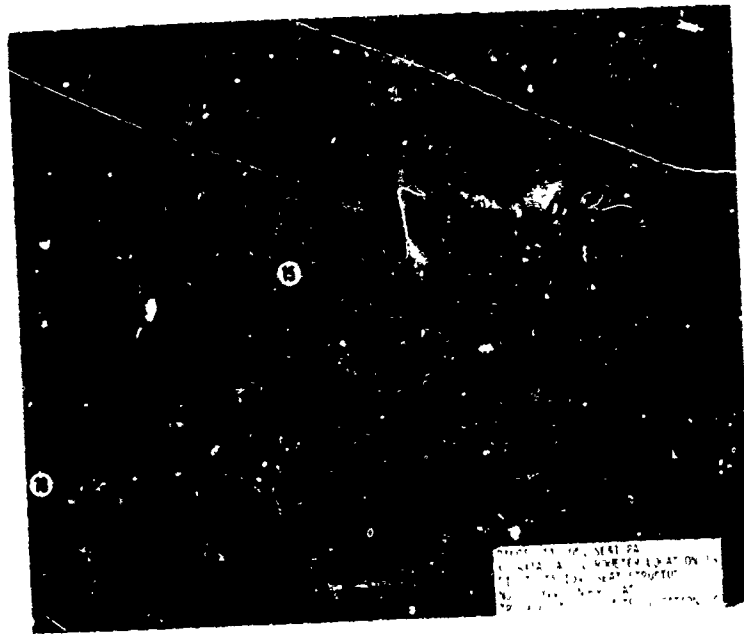

Photo 7.

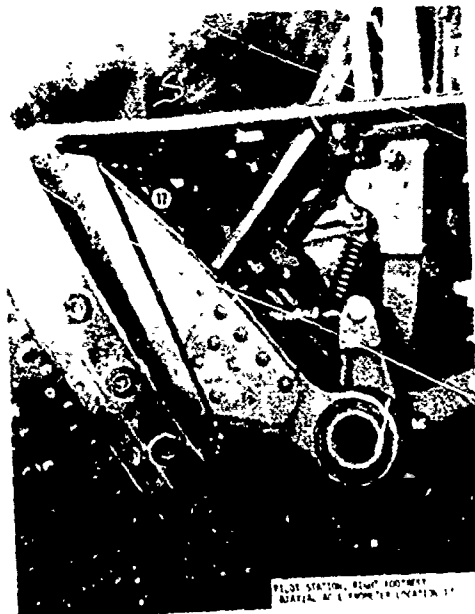
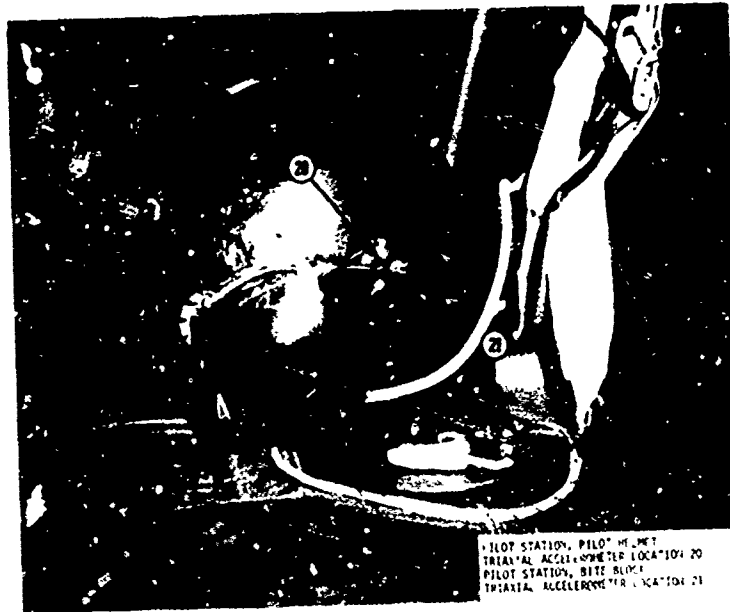

Photo 8.



PILOT STATION, CYCLIC GRIP
TRIAXIAL ACCELEROMETER LOCATION 19

Photo 9.



PILOT STATION, PILOT HELMET
TRIAXIAL ACCELEROMETER LOCATION 20
PILOT STATION, BITE BLOCK
TRIAXIAL ACCELEROMETER LOCATION 21

Photo 10.

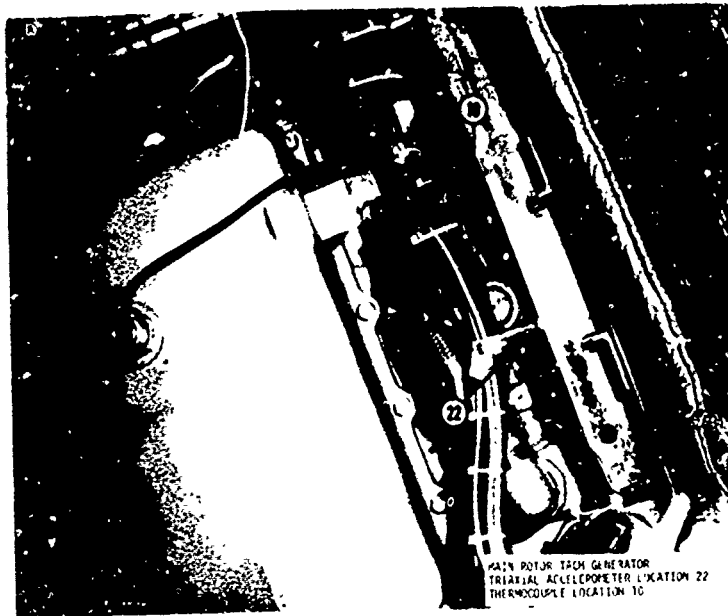
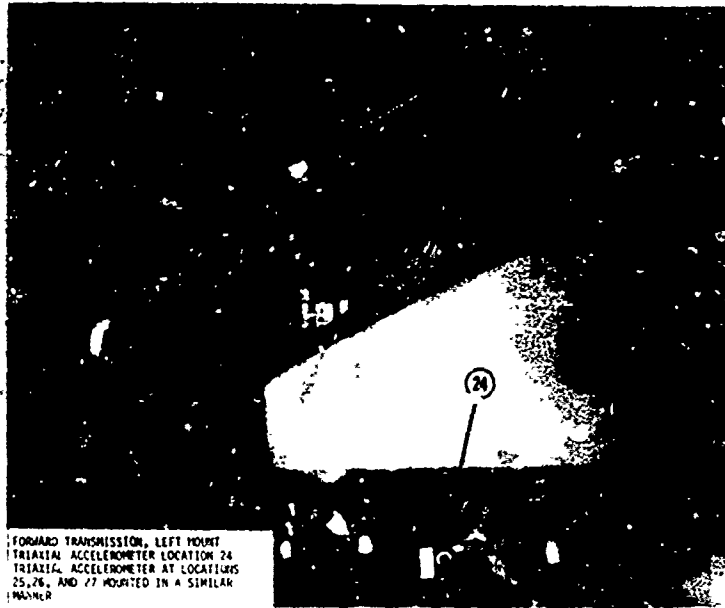

Photo 11.



Photo 12.



FORWARD TRANSMISSION, LEFT HOULT
TRIAIAL ACCELEROMETER LOCATION 24
TRIAIAL ACCELEROMETER AT LOCATIONS
25, 26, AND 27 MOUNTED IN A SIMILAR
MANNER

Photo 13.



FFT TRANSMISSION, LEFT HOULT
TRIAIAL ACCELEROMETER LOCATION 25
TRIAIAL ACCELEROMETER AT LOCATION
26, 27, AND 28 MOUNTED IN A SIMILAR
MANNER

Photo 14.

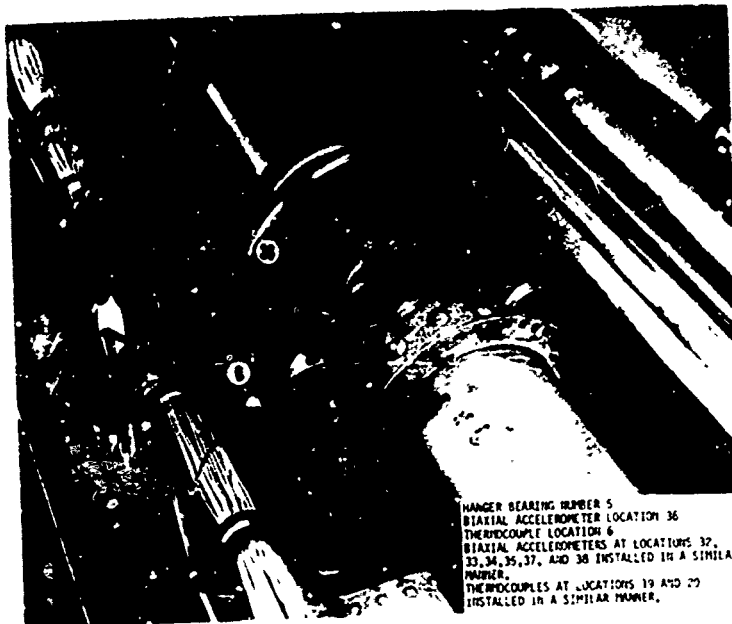

HANGER BEARING NUMBER 5
 BIAXIAL ACCELEROMETER LOCATION 36
 THERMOCOUPLE LOCATION 6
 BIAXIAL ACCELEROMETERS AT LOCATIONS 32,
 33, 34, 35, 37, AND 38 INSTALLED IN A SIMILAR
 MANNER.
 THERMOCOUPLES AT LOCATIONS 19 AND 29
 INSTALLED IN A SIMILAR MANNER.

Photo 15.

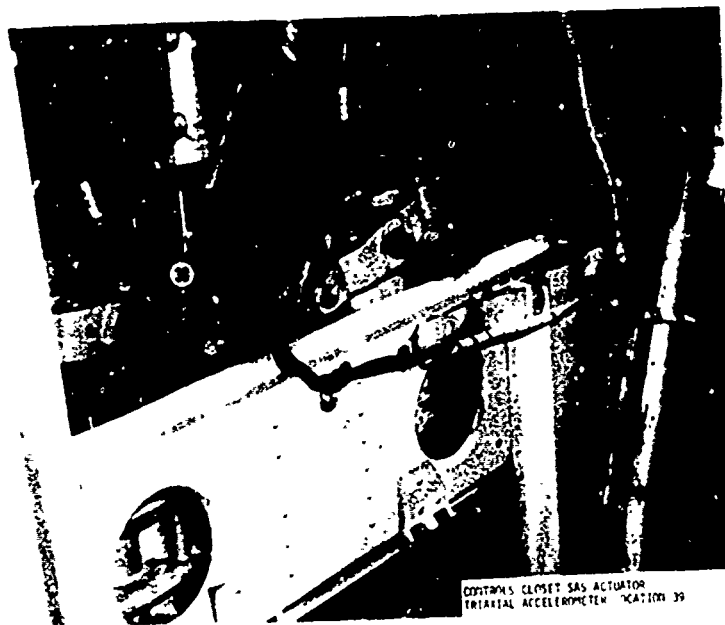

OPTIMUM CLOSEST SAS ACTUATOR
 TRIAXIAL ACCELEROMETER LOCATION 39

Photo 16.



Photo 17.

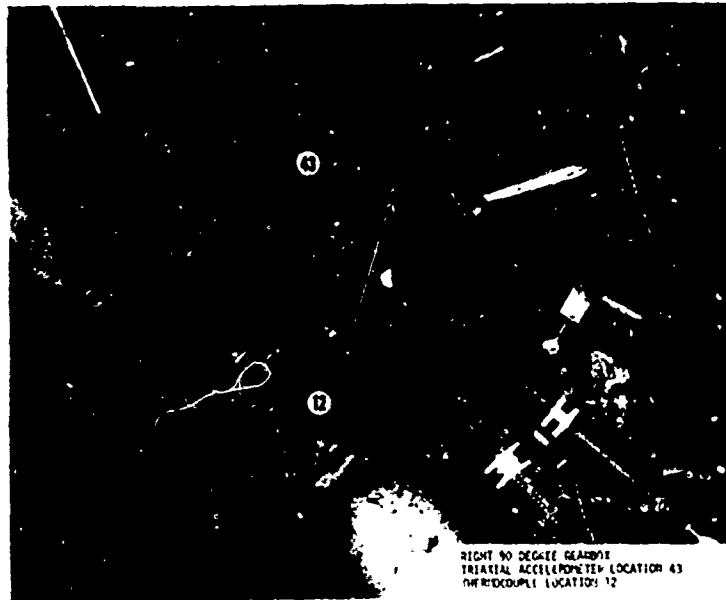

Photo 18.



RAFT TRANSMISSION SMASHPLATE ACTUATOR
TRIAXIAL ACCELEROMETER LOCATION: 42

Photo 19.



RIGHT 90 DEGREE GEARBOX
TRIAXIAL ACCELEROMETER LOCATION: 43
HYDROCOUPLER LOCATION: 12

Photo 20.

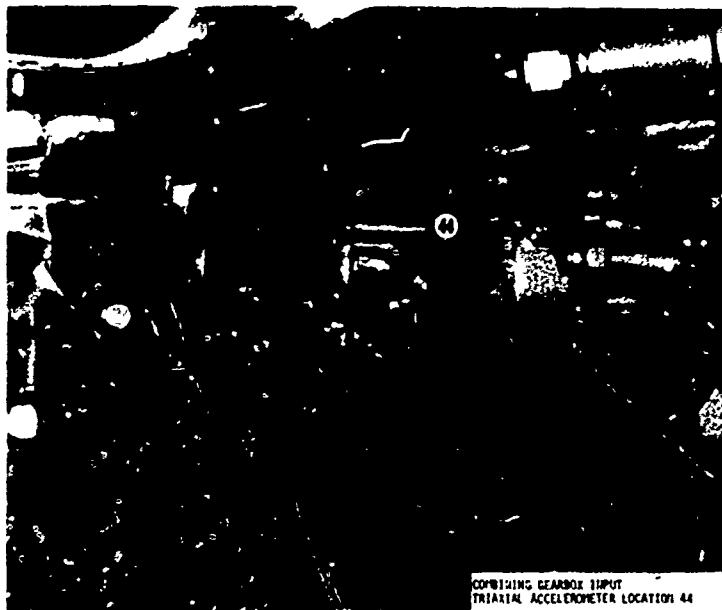
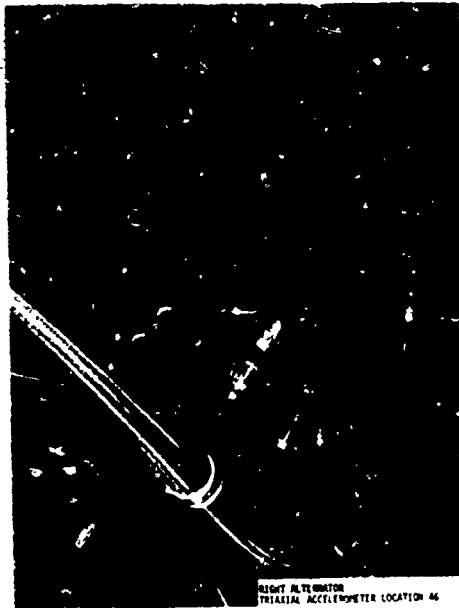

Photo 21.

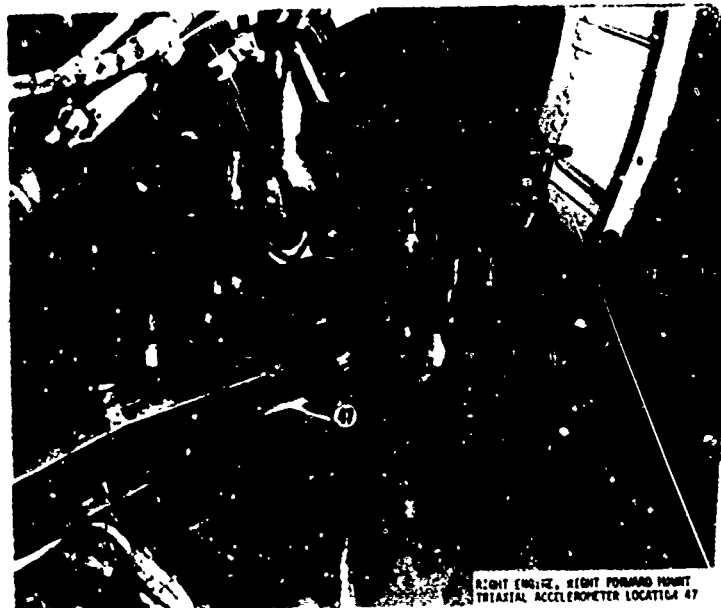

Photo 22.



RIGHT ALTERNATOR
TRIAXIAL ACCELEROMETER LOCATION 46

Photo 23.



RIGHT ENGINE, RIGHT FORWARD MOUNT
TRIAXIAL ACCELEROMETER LOCATION 47

Photo 24.

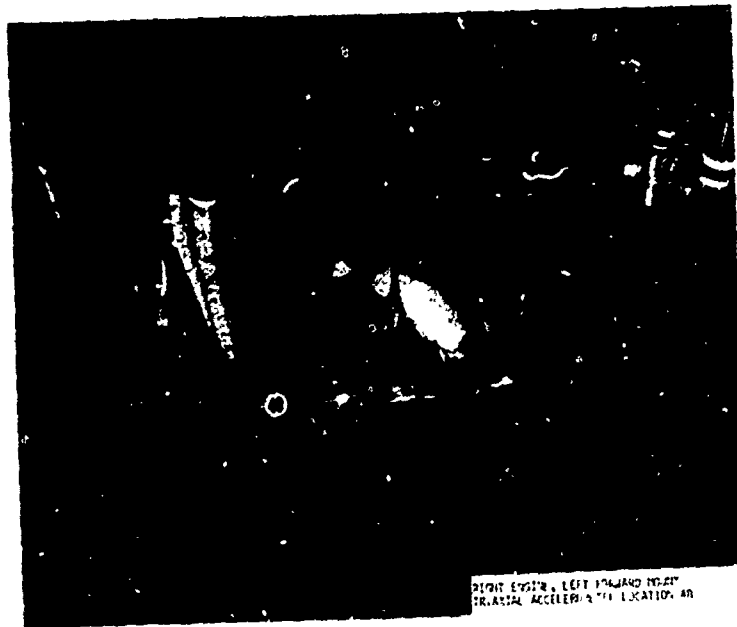

Photo 25.

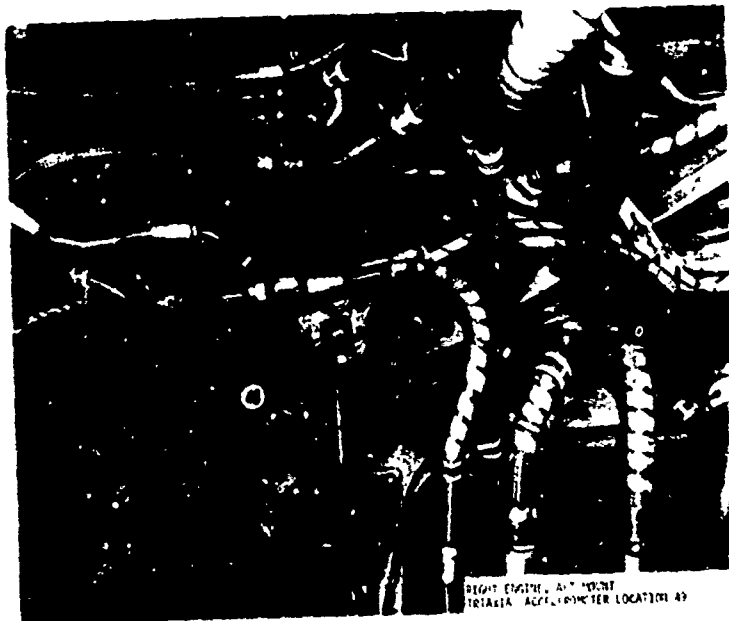
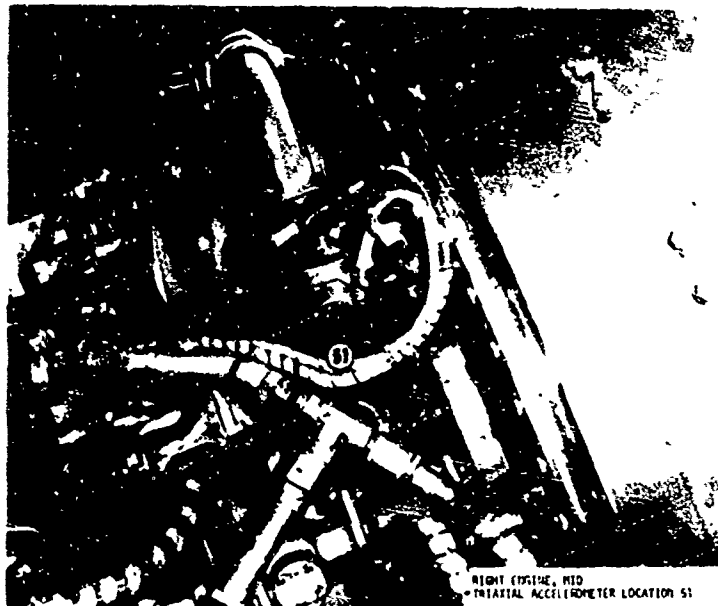

Photo 26.



RIGHT ENGINE, FORWARD
TRANSITIAL ACCELEROMETER LOCATION 50

Photo 27.



RIGHT ENGINE, MID
TRANSITIAL ACCELEROMETER LOCATION 51

Photo 28.

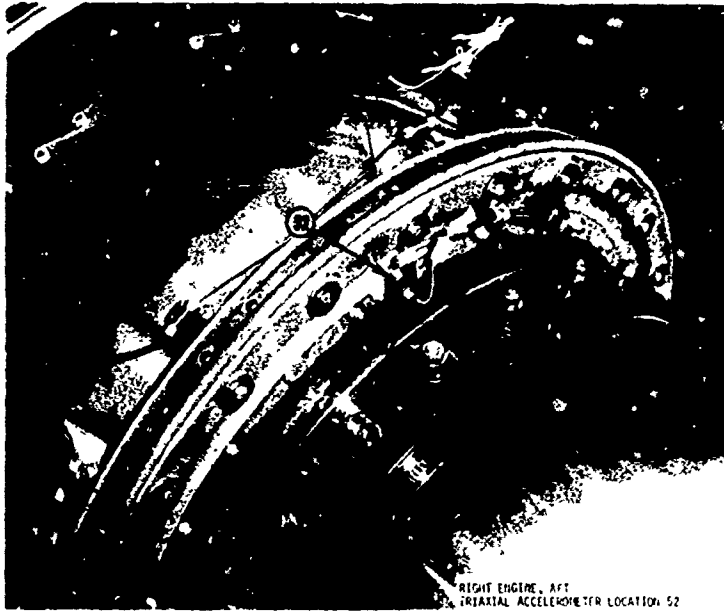

RIGHT ENGINE, AFT
TRIAXIAL ACCELEROMETER LOCATION 52

Photo 29.

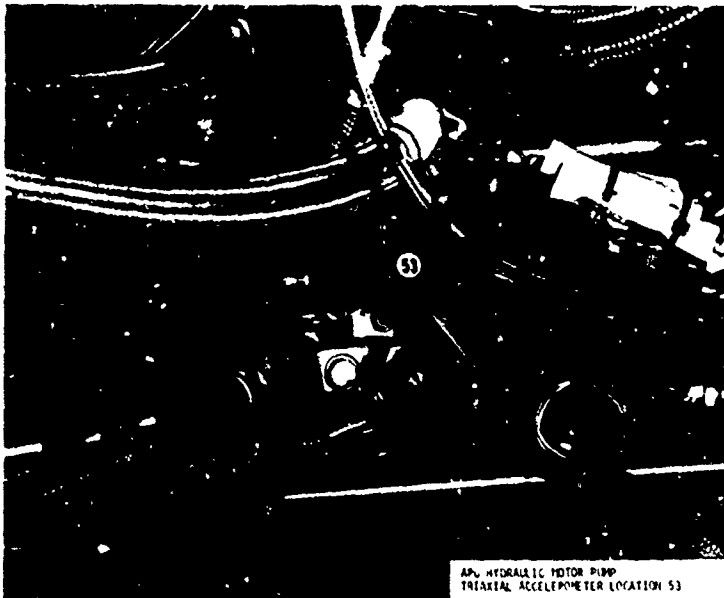

AFT HYDRAULIC MOTOR PUMP
TRIAXIAL ACCELEROMETER LOCATION 53

Photo 30.



Photo 31.

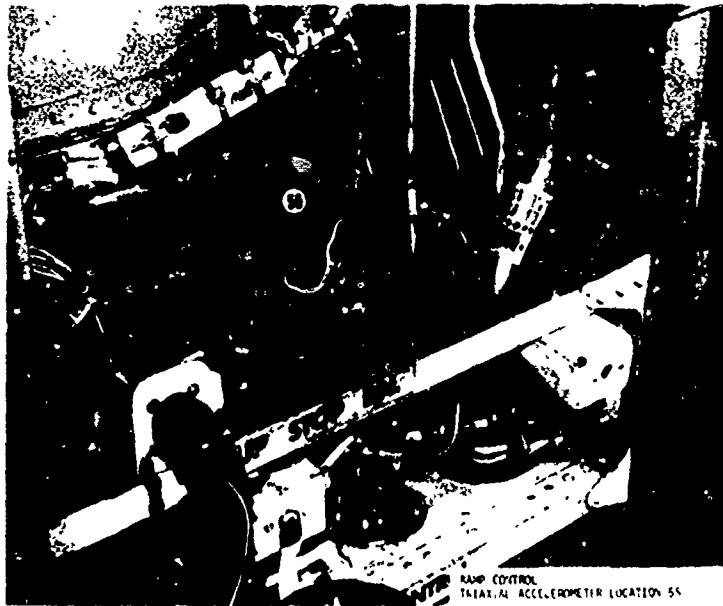

Photo 32.



AFT PYLON ANTI-COLLISION LIGHT
TRIAXIAL ACCELEROMETER LOCATION 56

Photo 33.



BELLY ANTI-COLLISION LIGHT
TRIAXIAL ACCELEROMETER LOCATION 57

Photo 34.

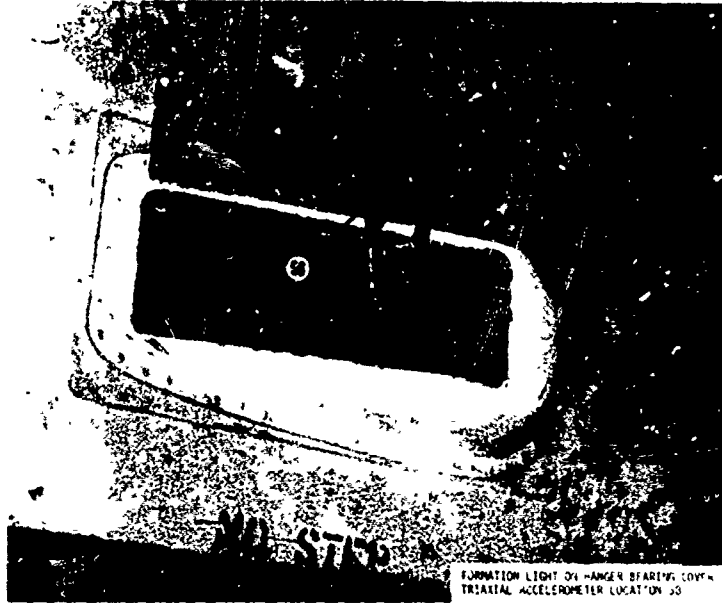

Photo 35.



Photo 36.



MT CARGO FLOOR
TRIAXIAL ACCELEROMETER LOCATION 60

Photo 37.



FASTENER, RIGHT 90 DEGREE GEAR BOX
TRIAXIAL ACCELEROMETER LOCATION 61

Photo 38.



BATTERY DISCONNECT LATCH
TRIAZILA ACCELEROMETER LOCATION 62

Photo 39.

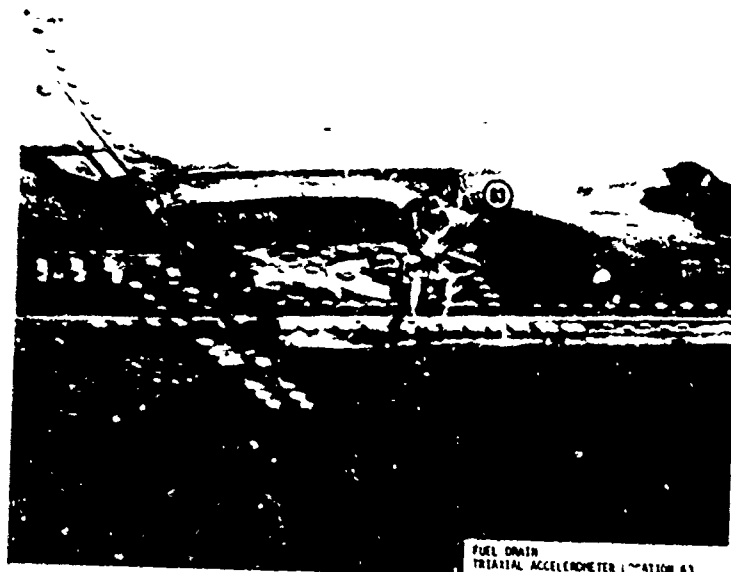

FUEL ORBIT
TRIAZILA ACCELEROMETER LOCATION 63

Photo 40.

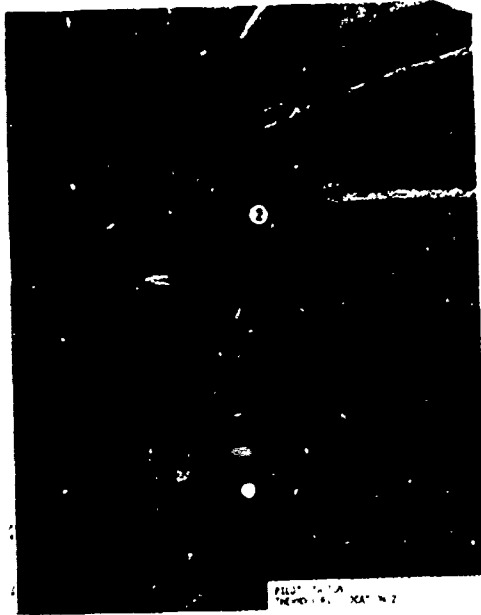

Photo 41.

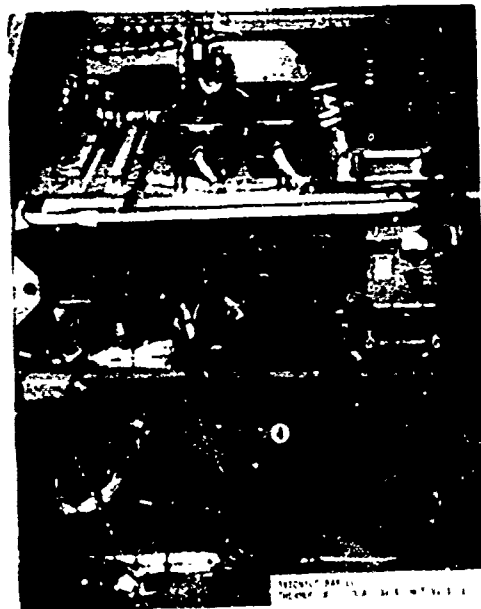

Photo 42.



AID CARGO COMPARTMENT
THERMOCOUPLE LOCATION 7 (NOT INSTALLED)

Photo 43.



BATTERY COMPARTMENT
THERMOCOUPLE LOCATION 8

Photo 44.



Photo 45.

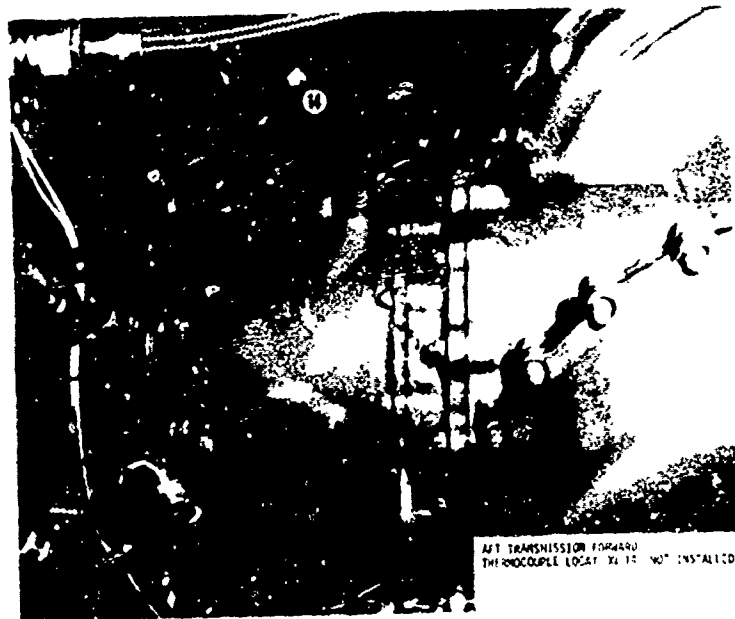

Photo 46.

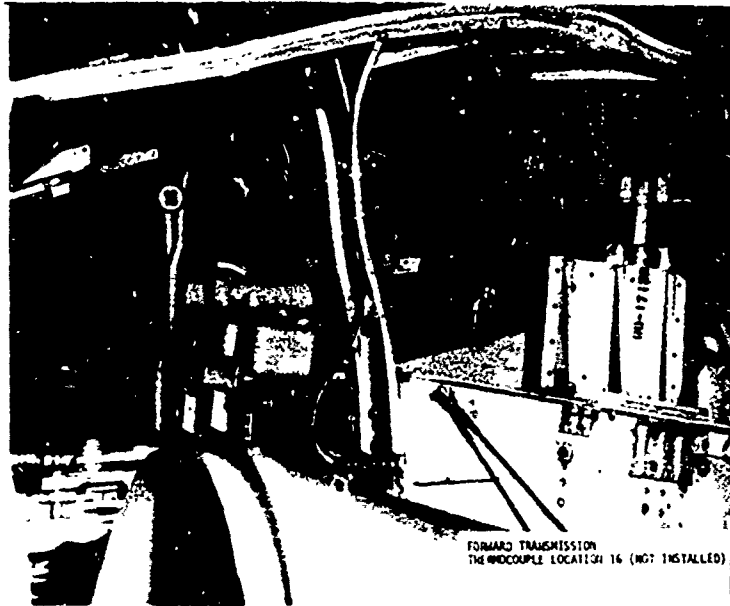

Photo 47.



Photo 48.



Photo 49.

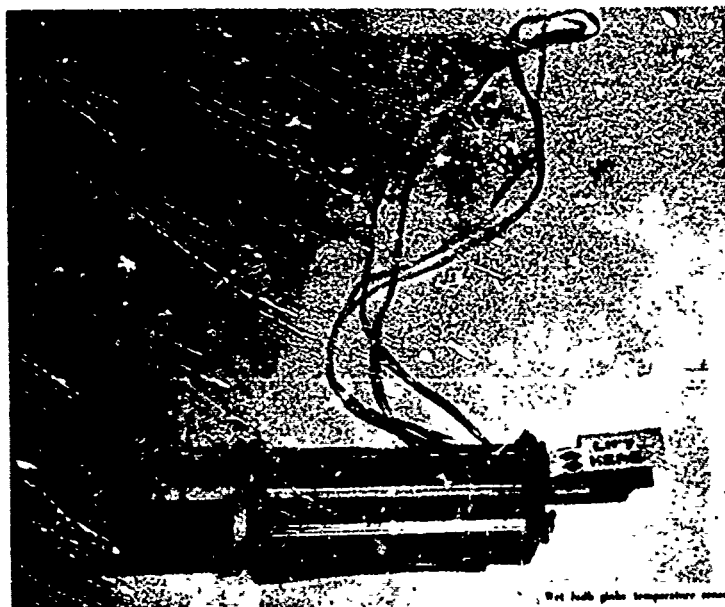

Photo 50.

APPENDIX D. TEST AND DATA ANALYSIS METHODS

1. Because of the discrete frequency content of the data, a narrow-band spectral analysis was performed. A Spectral Dynamics 301 real-time spectral analyzer was utilized to perform the spectral analysis. This spectral analysis converted the data from the time domain (acceleration as a function of time) to the frequency domain (acceleration as a function of frequency). The output of the spectral analysis was a digital plot of acceleration versus frequency composed of acceleration values at 500 discrete frequencies uniformly spaced over the selected frequency range of the spectrum analyzer. The data were analyzed on the zero-to-2000-Hz analysis range with a resolution bandwidth of 4 Hz. Because of the random variation in amplitude, the data were averaged over a period of time to determine the mean acceleration amplitude for each test condition. This data averaging was accomplished with a Spectral Dynamics 302B ensemble averager. Data were averaged over an 8-second time interval for steady-state nonweapons-firing flight conditions and a 2-second interval for maneuvering flight. The 2-second maneuvering flight analysis time interval was selected to cover the most severe vibrations encountered during the maneuver.

2. The following equations were used to calculate the acceleration mean and standard deviation values:

a. Mean (\bar{X}):

$$\bar{X} = \frac{\sum_{j=1}^N X_j}{N}$$

b. Standard deviation (S):

$$S = \sqrt{\frac{\sum_{j=1}^N (X_j - \bar{X})^2}{N}}$$

c. Mean plus standard deviation (Y):

$$Y = \bar{X} + S$$

Where:

X_j = Acceleration at a specific frequency

N = Number of records compressed

3. Figures 1 and 2 are block diagrams of the spectral analysis and data compression procedures.

TEMPERATURE DATA

4. The electrical analogue shown in figure 3 was developed to predict the temperature of the cabin and avionics under static conditions at values of ambient air temperature and external radiation different than those tested. The results of this analysis are presented in figures 116 through 122, appendix E.

5. Using the circuit shown in figure 3, the equation describing the transient response of the helicopter to an ambient air temperature and source of external radiation can be written as:

$$T_c = e^{-t/K_{eq}} C \left[T_o - \frac{T_a K_r + E_{ex} K_c K_r}{K_c + K_r} \right] + \frac{T_a K_r + E_{ex} K_c K_r}{K_c + K_r} \quad (1)$$

Where:

$$K_{eq} = \frac{K_c K_r}{K_c + K_r}$$

When t (time) $\rightarrow \infty$ the steady-state helicopter temperature T_{ss} is given by:

$$T_{ss} = \frac{T_a K_r + E_{ex} K_c K_r}{K_c + K_r} \quad (2)$$

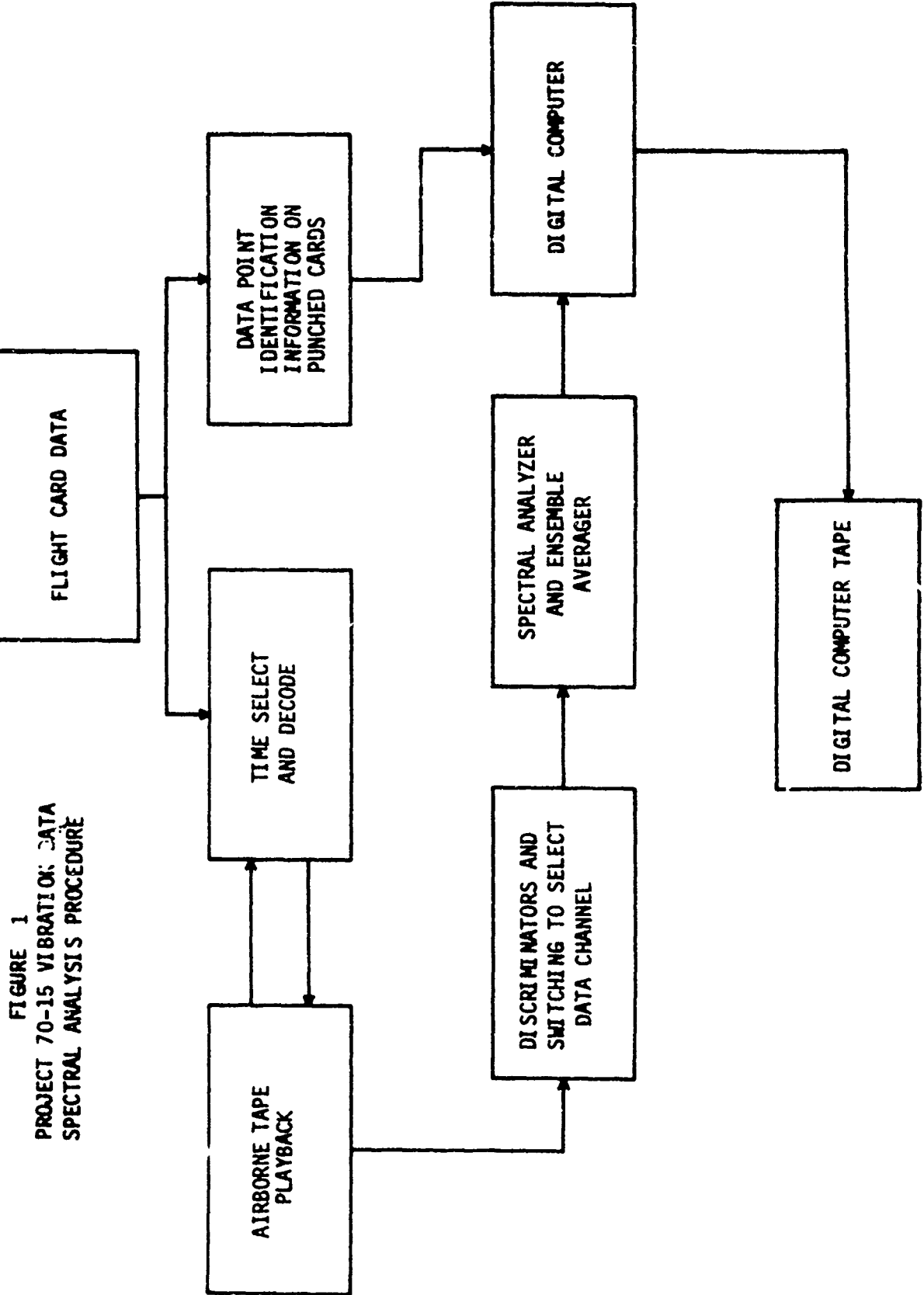
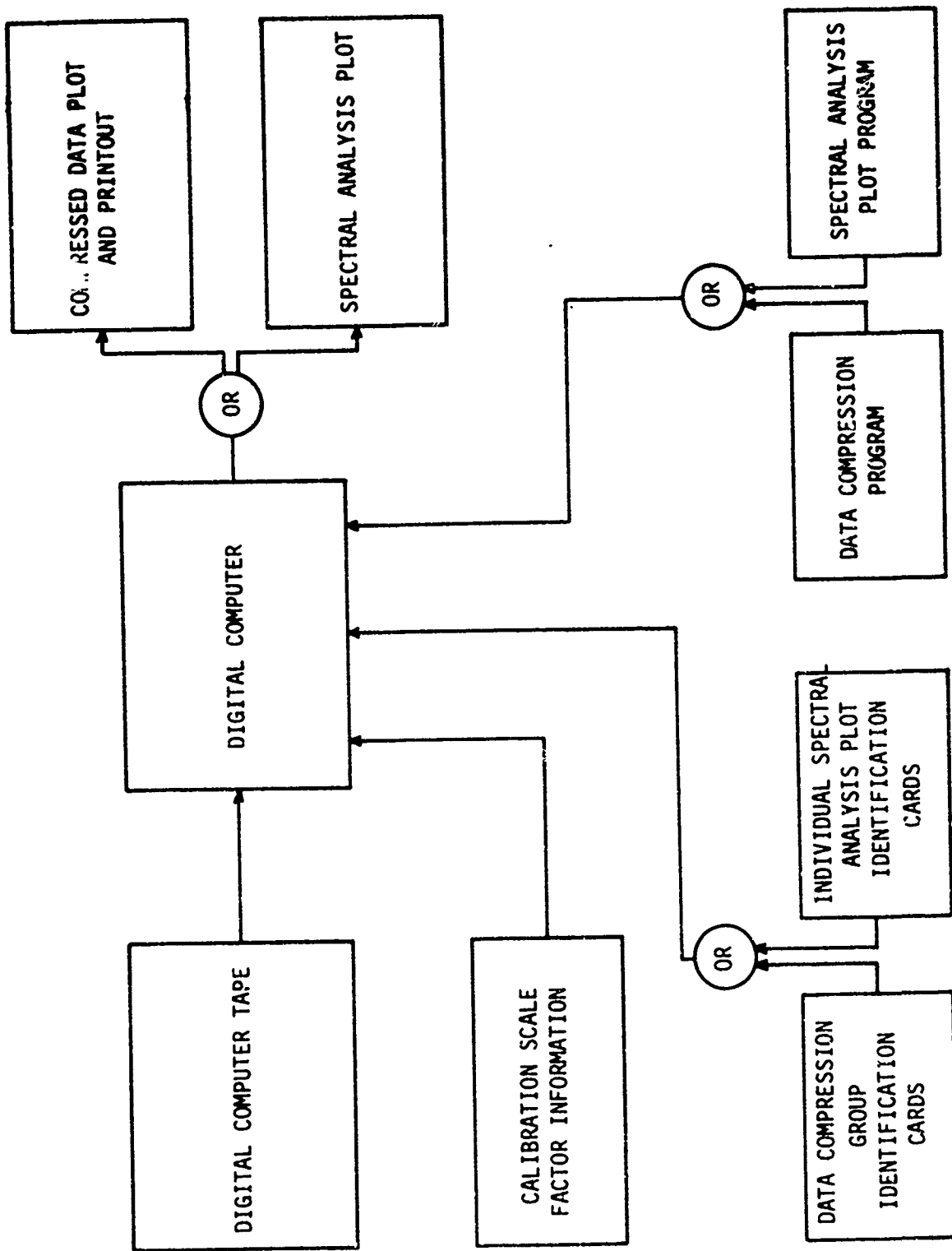

FIGURE 1
PROJECT 70-15 VIBRATION: DATA
SPECTRAL ANALYSIS PROCEDURE

FIGURE 2
PROJECT 70-15 VIBRATION DATA
COMPRESSION PROCEDURE



<u>ELECTRICAL QUANTITY</u>	<u>HEAT TRANSFER QUANTITY</u>	<u>UNIT (K)</u>
V ~ Voltage	T_a ~ Ambient air temperature	K
V_c ~ Voltage across capacitor	T_c ~ Transient temperature inside helicopter	K
	T_{ss} ~ Steady-state temperature inside helicopter	K
	T_o ~ Initial temperature inside helicopter	K
R_1 ~ Resistance	K_c ~ Conduction coefficient	Hr · K/BTU
R_2 ~ Resistance	K_r ~ Radiation heat transfer coefficient	Hr · K/BTU
C ~ Capacitor	C ~ Heat capacity	BTU/°C
I ~ Current	E_{ex} ~ Total external radiation	BTU/hr
	E_a ~ Atmospheric radiation (total external radiation minus solar radiation)	BTU/hr
	E_s ~ Solar radiation	BTU/hr
t ~ Time	t ~ Time	Hr

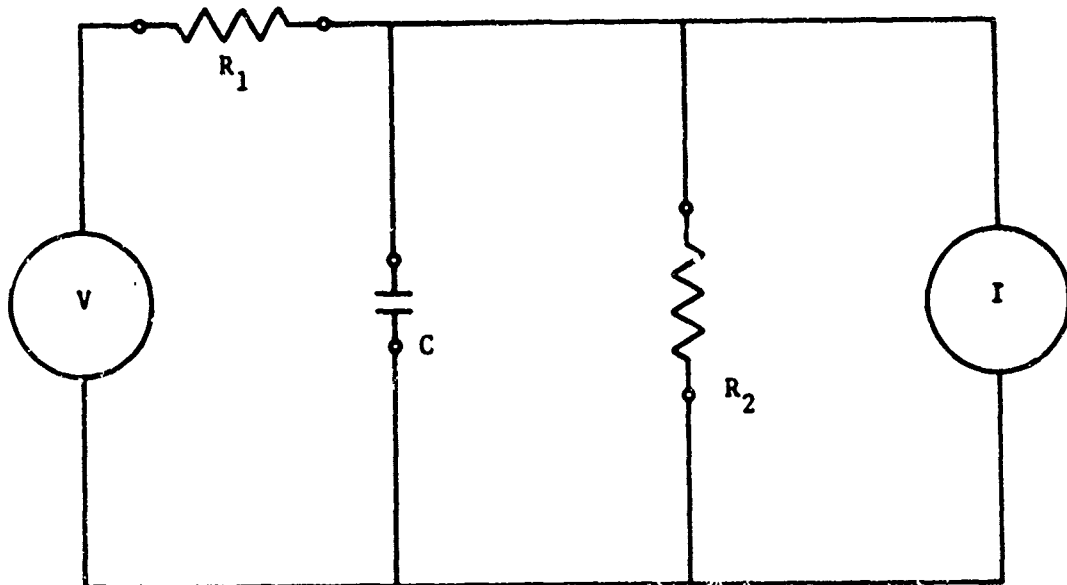

Figure 3. Heat Transfer Electrical Analog.

Where:

$$E_{ex} = E_s + \sigma T_a^4$$

$$\sigma = 1.8 \times 10^{-8} \text{ BTU/ft}^2 \cdot \text{hour} \cdot \text{K}^4$$

6. Equation 2 was used to find K_C and K_R by allowing the helicopter to reach its steady-state temperature at two different constant ambient air temperatures (T_{a1} and T_{a2}) and at two different external radiation values (E_{ex1} and E_{ex2}). This resulted in two equations with two unknowns, K_C and K_R , which were solved for K_C and K_R , equations 3 and 4.

$$K_C = \frac{T_{a2} T_{ss1} - T_{a1} T_{ss2}}{E_{ex1} T_{ss2} - E_{ex2} T_{ss1}} \quad (3)$$

$$K_R = \frac{T_{ss1} K_C}{T_{a1} + E_{ex1} K_C - T_{ss1}} \quad (4)$$

7. A different K_C and K_R were calculated for each temperature sensor location. Each location was considered to comprise an area of 1 square foot which enabled the measured external radiation value in units of BTU/ft²-hr to be converted to BTU/hr. These values of K_C and K_R were then inserted into equation 2 in order to calculate the steady-state temperature at each temperature sensor location for different values of solar radiation and ambient air temperature than those tested (figs. 116 through 122, app E).

WET BULB GLOBE TEMPERATURE CALCULATION

8. The WBGT index is calculated from the following equation:

$$\text{WBGT} = 0.7\text{WB} + 0.2\text{GT} + 0.1\text{DB}$$

Where:

WB = Naturally convected wet bulb temperature - °F

DB = Dry bulb temperature - °F

GT = Globe temperature - °F

For an outside air temperature of 100°F and a solar radiation value of 333 BTU/hr-ft², a cabin temperature rise of 7.2°F and a globe temperature rise of 9.7°F can be determined. The cabin temperature rise is added to the outside air temperature of 100°F to give a cabin temperature of 107.2°F. The globe temperature rise of 9.7°F is added to the cabin temperature to give a globe temperature of 116.9°F. At a relative humidity of 50 percent at 100°F, a psychrometric chart (shown on the next page) can be used to determine a wet bulb temperature of 84.5°F for a cabin dry bulb temperature of 107.2°F. Using these temperature values, the WBGT can be calculated.

$$\text{WBGT} = (0.7) (84.5) + (0.2) (116.9) + (0.2) (107.2) = 97.4^\circ\text{F}$$

PSYCHROMETRIC CHART

BAROMETRIC PRESSURE 29.92 IN Hg

TEMPERATURE OF 100 °F.

1. ENTER CHART AT OUTSIDE AIR TEMPERATURE OF 107.2 °F.
2. GO TO 50% RELATIVE HUMIDITY.
3. HEAT OUTSIDE AIR TO CABIN TEMPERATURE OF 107.2 °F AT CONSTANT SPECIFIC HUMIDITY.
4. GO TO A WET BULB TEMPERATURE OF 64.5 °F AT A CABIN RELATIVE HUMIDITY OF 10%.

RELATIVE HUMIDITY

WET BULB TEMPERATURE ~ °F

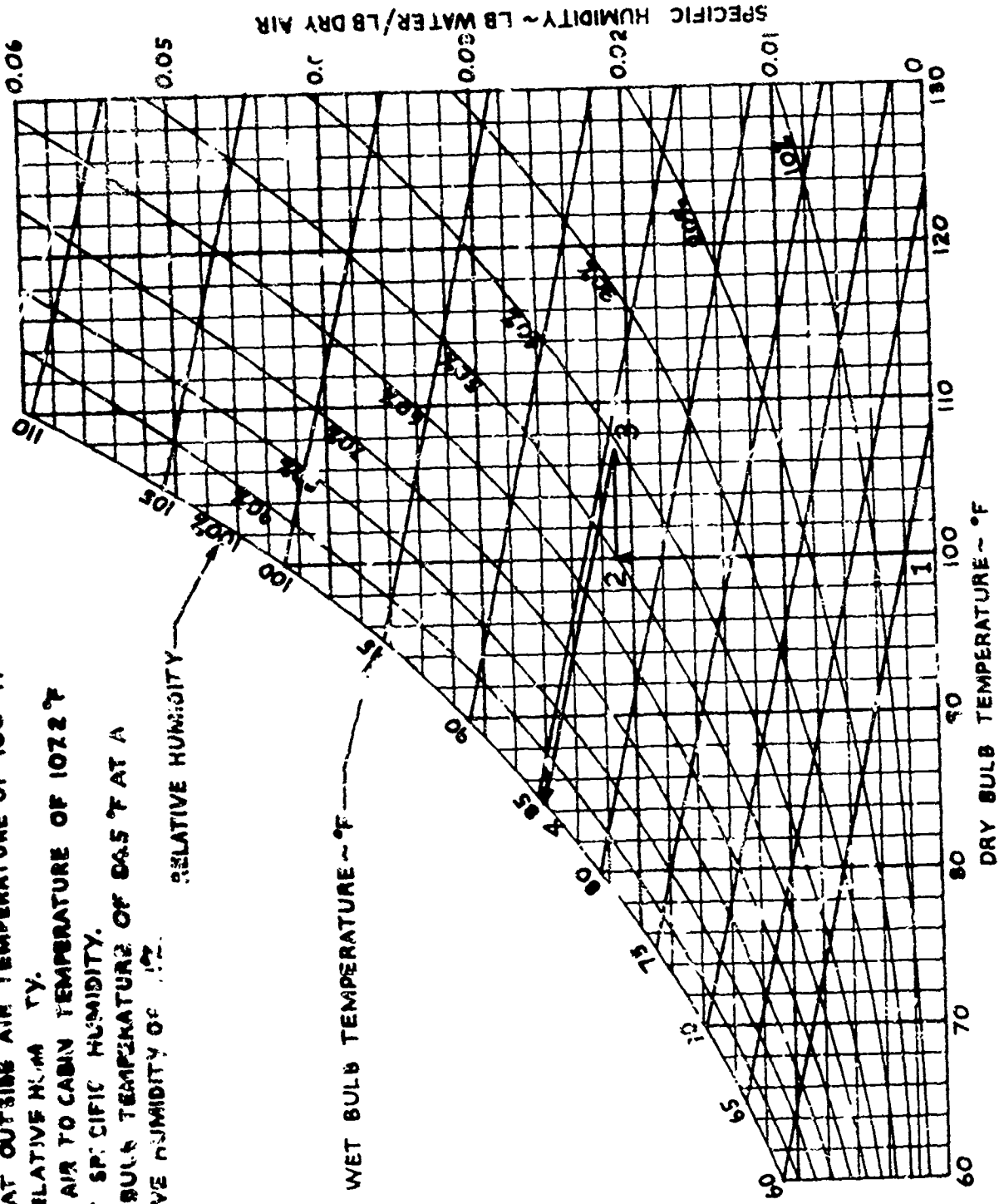

DRY BULB TEMPERATURE ~ °F

APPENDIX E. TEST DATA

INDEX

<u>Figure (Compression Number)</u>	<u>Figure Number</u>
All Test Conditions Vibration:	
Data Compression Arrays	1 through 3
Instruments (148)	4 and 5
Avionics (149)	6 and 7
Stability Augmentation System (150)	8 and 9
Pilot Input (151)	10 and 11
Pilot (152)	12 and 13
Tach Generators (153)	14 and 15
Forward Transmission Mounts (154)	16 and 17
Aft Transmission Mounts (155)	18 and 19
Hanger Bearings (156)	20 and 21
Hydraulic Actuators (157)	22 and 23
Gearboxes (158)	24 and 25
Right Alternator (159)	26 and 27
Right Engine Mounts (160)	28 and 29
Right Engine (161)	30 and 31
Hydraulic Pumps (162)	32 and 33
Ramp Control (163)	34 and 35
Lights (164)	36 and 37
Cargo Floor (165)	38 and 39
Dzeus Fastener (166)	40 and 41
Battery Compartment Latch (167)	42 and 43
Fuel Drain (168)	44 and 45
Instrument Vibration:	
Hover (1)	46 and 47
Level Flight (2)	48 and 49
Climb (3)	50 and 51
Descent (4)	52 and 53
Takeoff and Landing (5)	54 and 55
Turns (6)	56 and 57
Ground Run (7)	58 and 59

Avionics Vibration:

Hover (8)	60 and 61
Level Flight (9)	62 and 63
Climb (10)	64 and 65
Descent (11)	66 and 67
Takeoff and Landing (12)	68 and 69
Turns (13)	70 and 71
Ground Run (14)	72 and 73

Stability Augmentation System Vibration:

Hover (15)	74 and 75
Level Flight (16)	76 and 77
Climb (17)	78 and 79
Descent (18)	80 and 81
Takeoff and Landing (19)	82 and 83
Turns (20)	84 and 85
Ground Run (21)	86 and 87

Pilot Input Vibration:

Hover (22)	88 and 89
Level Flight (23)	90 and 91
Climb (24)	92 and 93
Descent (25)	94 and 95
Takeoff and Landing (26)	96 and 97
Turns (27)	98 and 99
Ground Run (28)	100 and 101

Pilot Vibration:

Hover (29)	102 and 103
Level Flight (30)	104 and 105
Climb (31)	106 and 107
Descent (32)	108 and 109
Takeoff and Landing (33)	110 and 111
Turns (34)	112 and 113
Ground Run (35)	114 and 115

Static Temperatures:

Instrument Panel Back	116
Cockpit	117
Controls Closet	118
Mid Cargo Compartment	119
Right Electronics Compartment	120
Forward Transmission	121
Hanger Bearing No. 1	122

FIGURE 1
FIRST PASS DATA COMPRESSION ARRAY

CH-47C USA S/N 69-17126

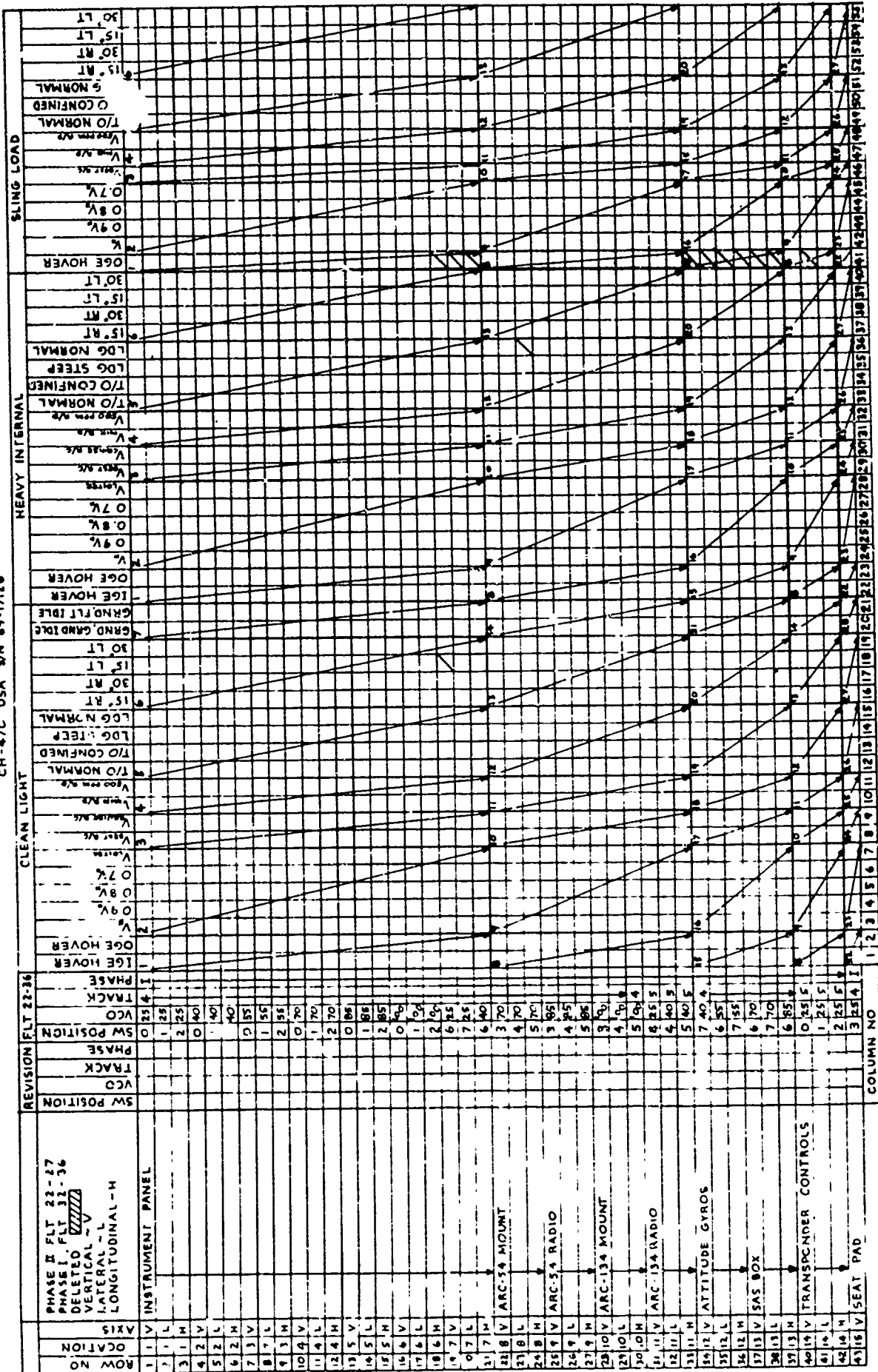

CH-47C USA S/N 69-17126

FIGURE 1
FIRST PASS DATA COMPRESSION ARRAY

PAGE 2 OF 5

CH-47C USA S/N 69-17126

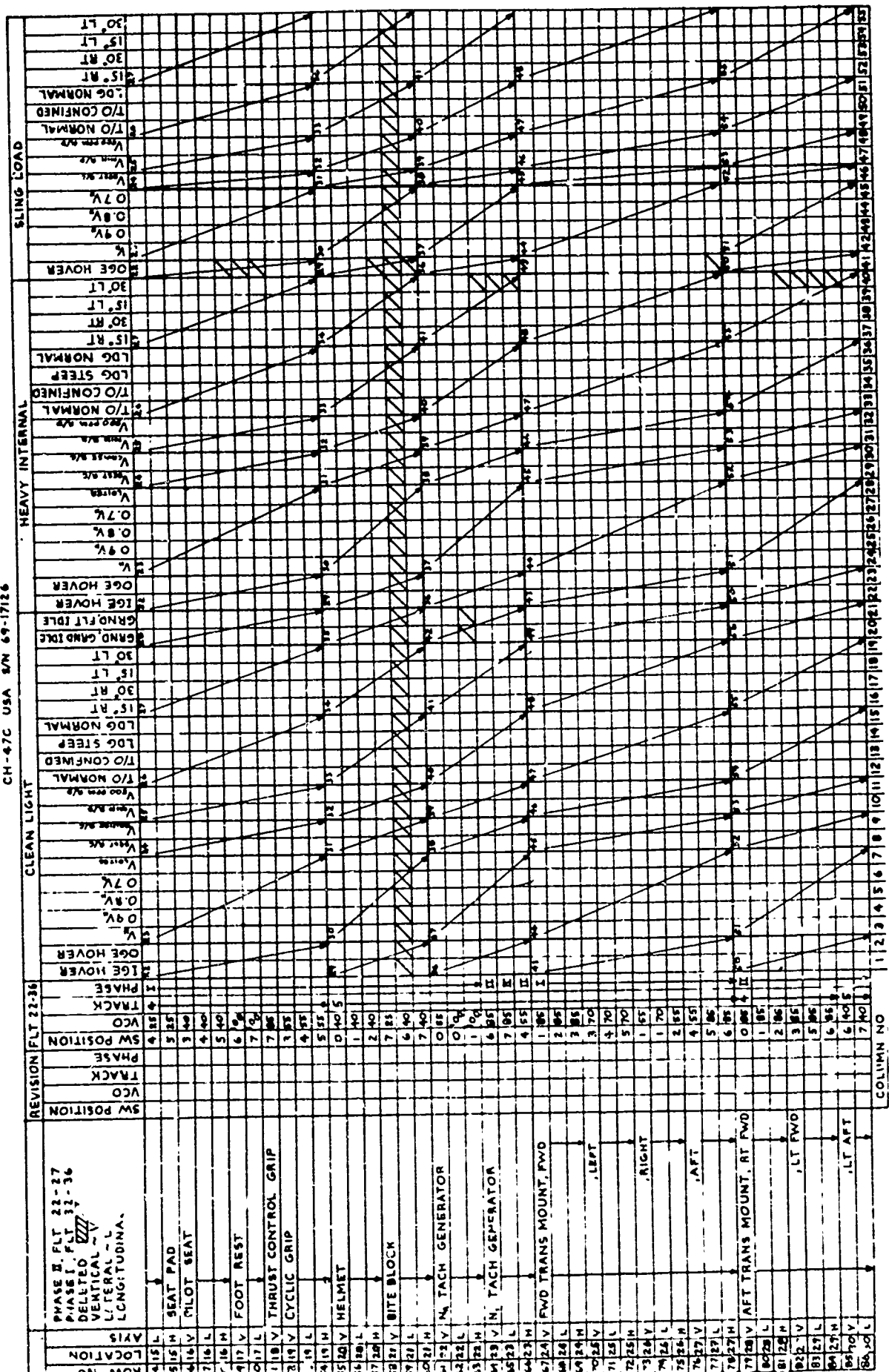

1-2-78

FIGURE 1
FIRST PASS DATA COMPRESSION ARRAY

PAGE 2 OF 5

CH-47C USA S/N 69-17126

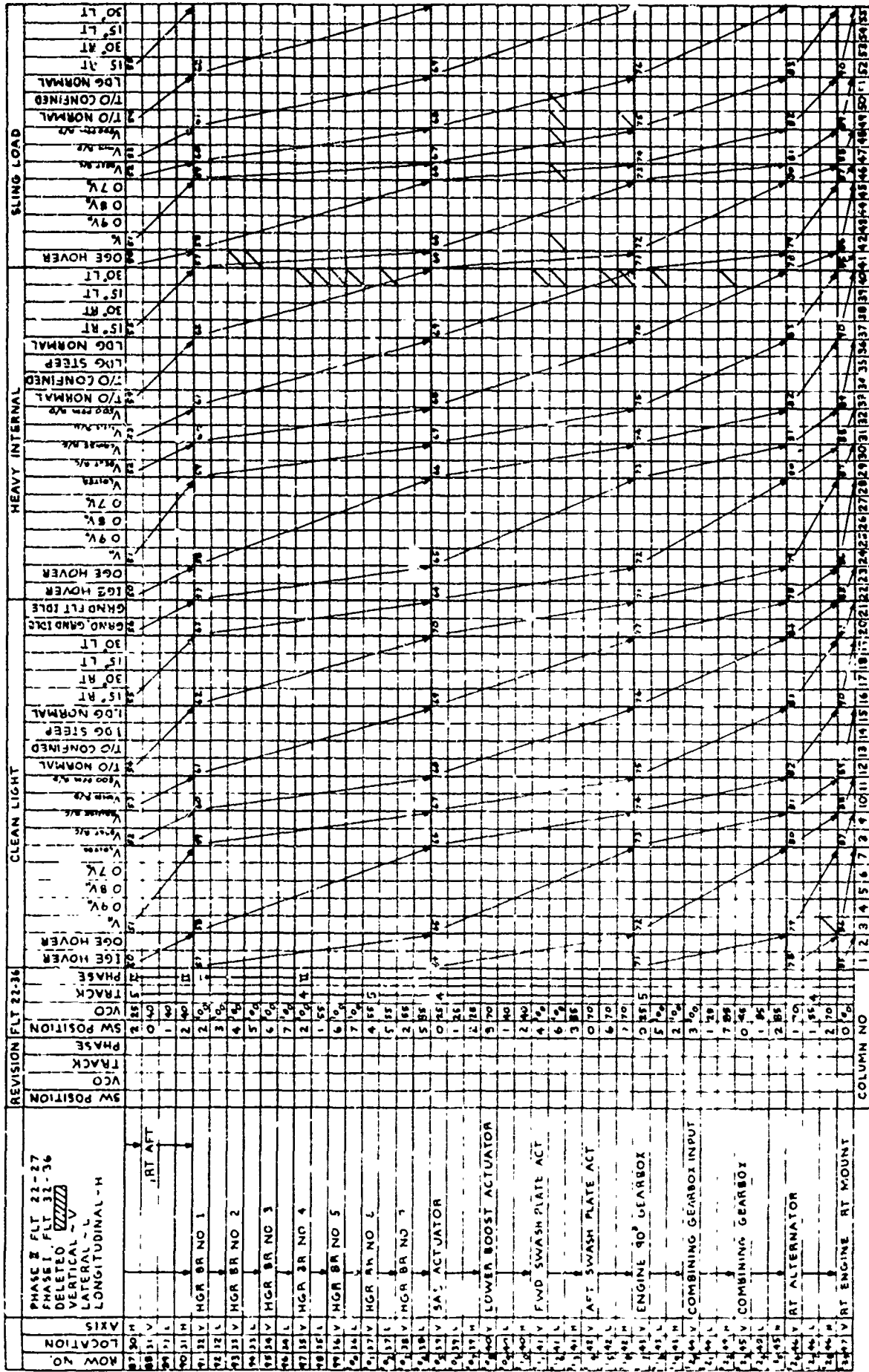

FIGURE 1
FIRST PASS DATA COMPRESSION ARRAY

CH-47C USA S/N 69-17126

PAGE 4 OF 5

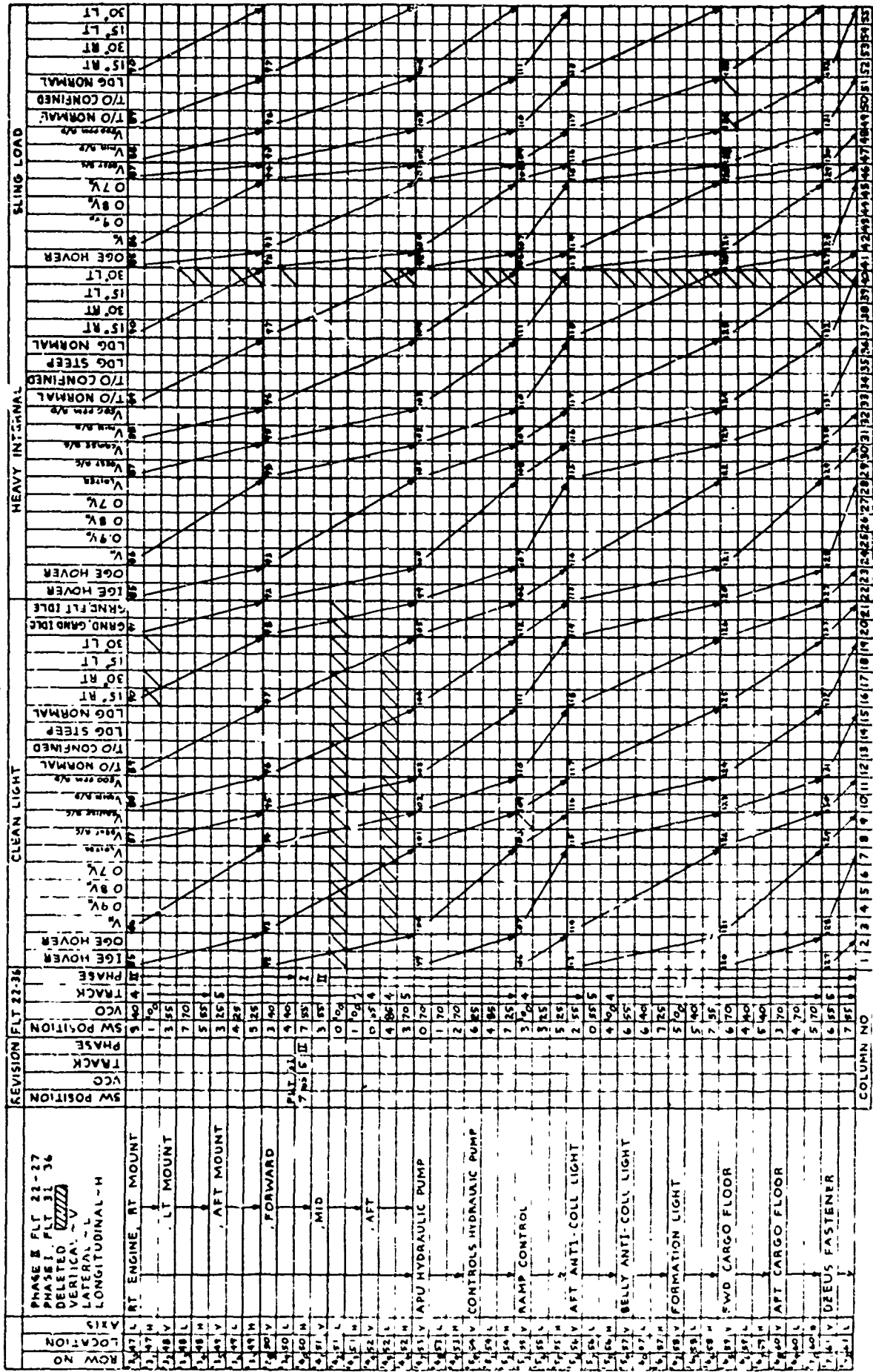
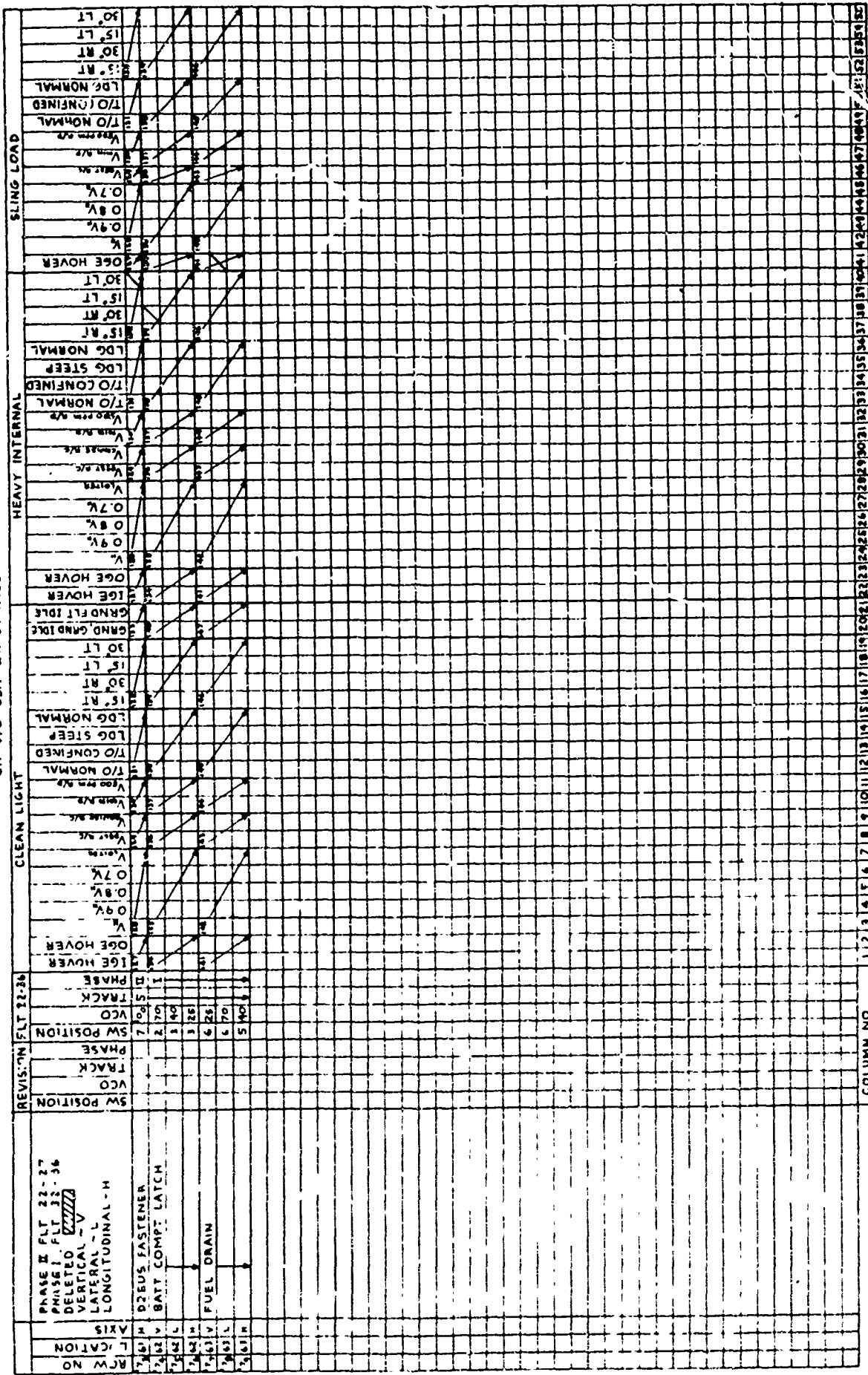

FIGURE 1
FIRST PASS DATA COMPRESSION ARRAY

PAGE 1 OF 3

CH-47C USA SN 69-17126



COLUMN NO

1 2 3 4 5 6 7 8 9 10 11 12 13 14 15 16 17 18 19 20 21 22 23 24 25 26 27 28 29 30 31 32

FIGURE 2
SECOND PASS DATA COMPRESSION ARRAY
 CH-47C USA S/N 69-17126

PAGE 1 OF 1

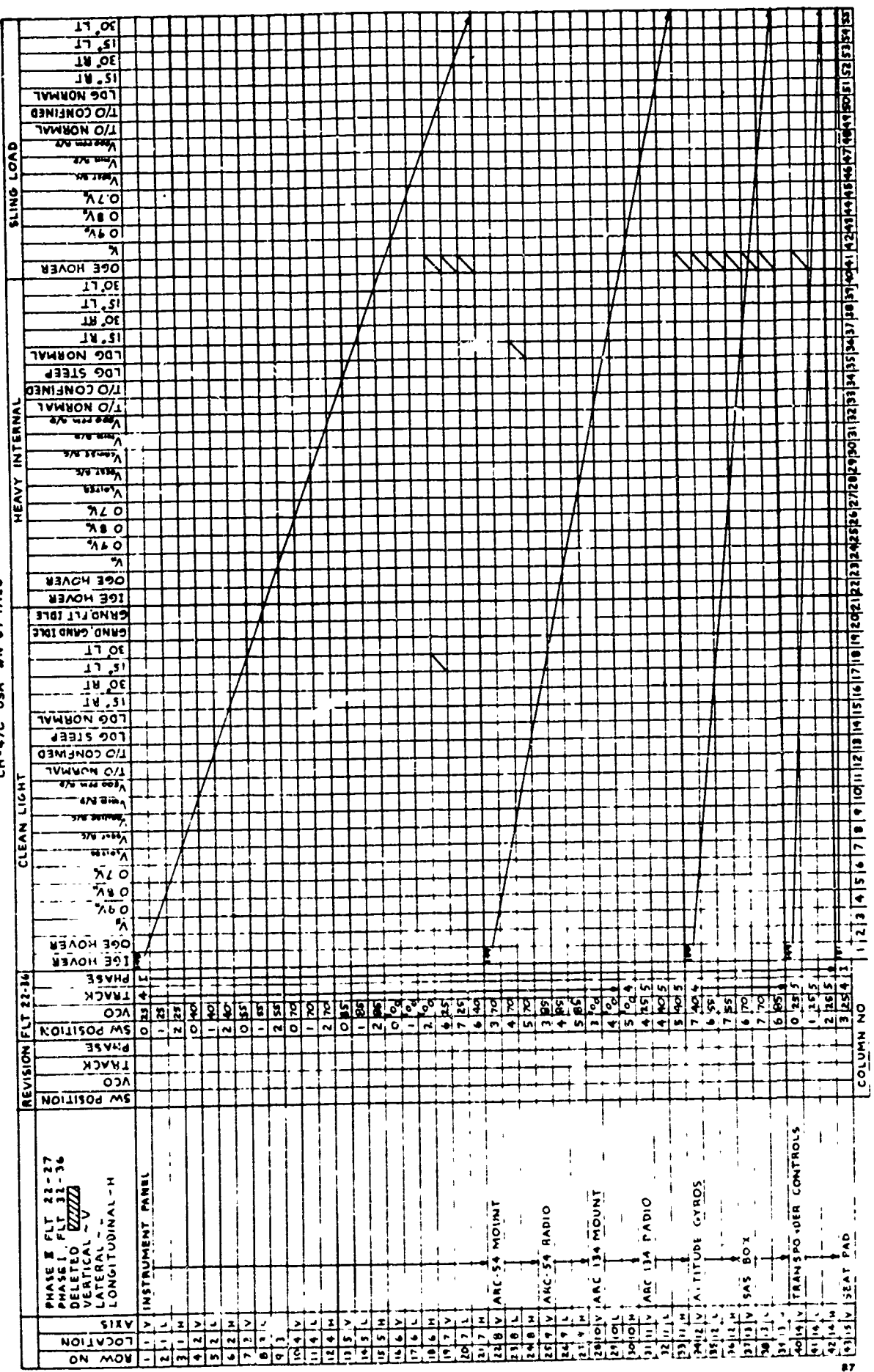

COLUMN NO

FIGURE 2
SECOND PASS DATA COMPRESSION ARRAY

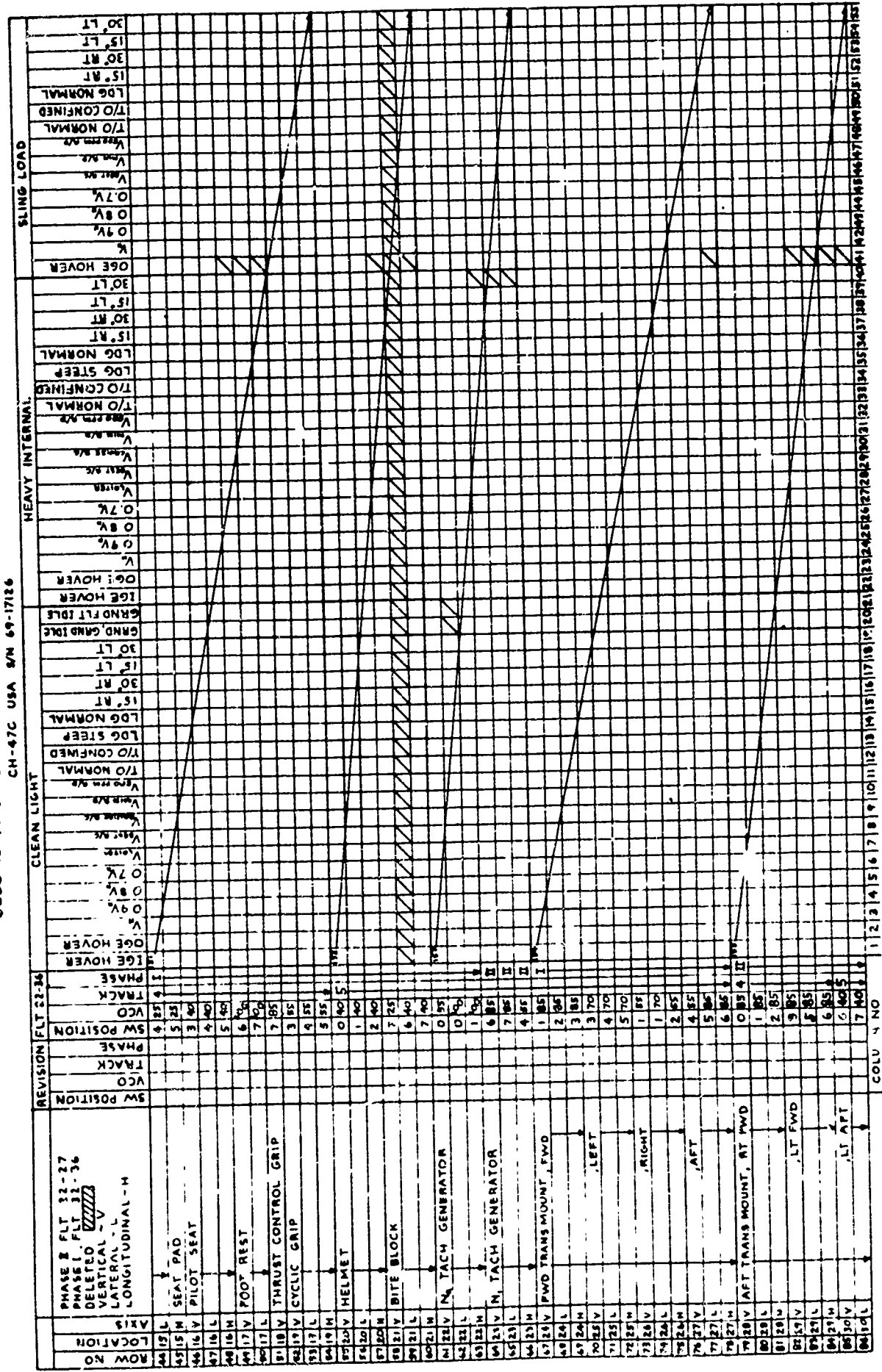
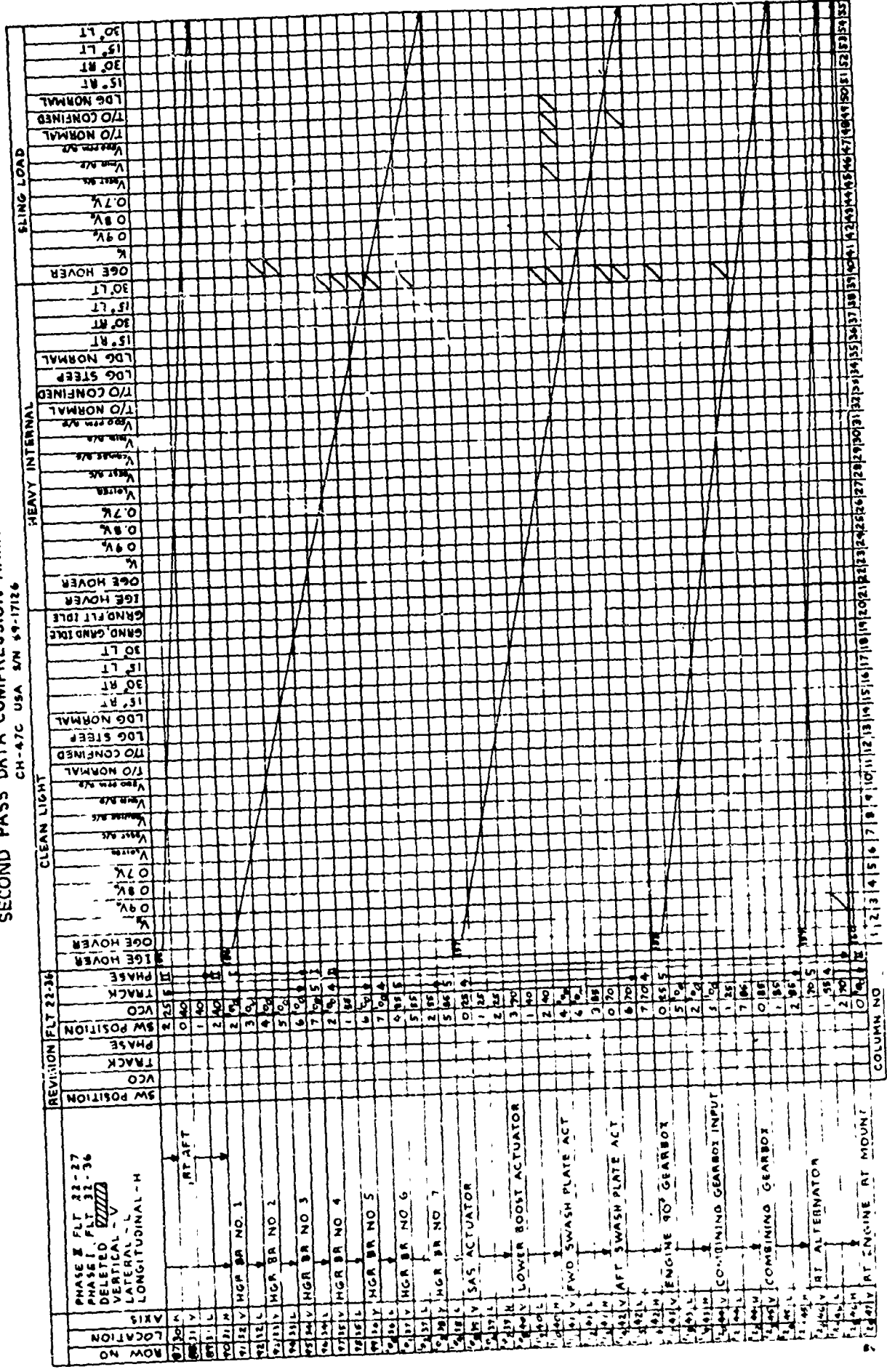
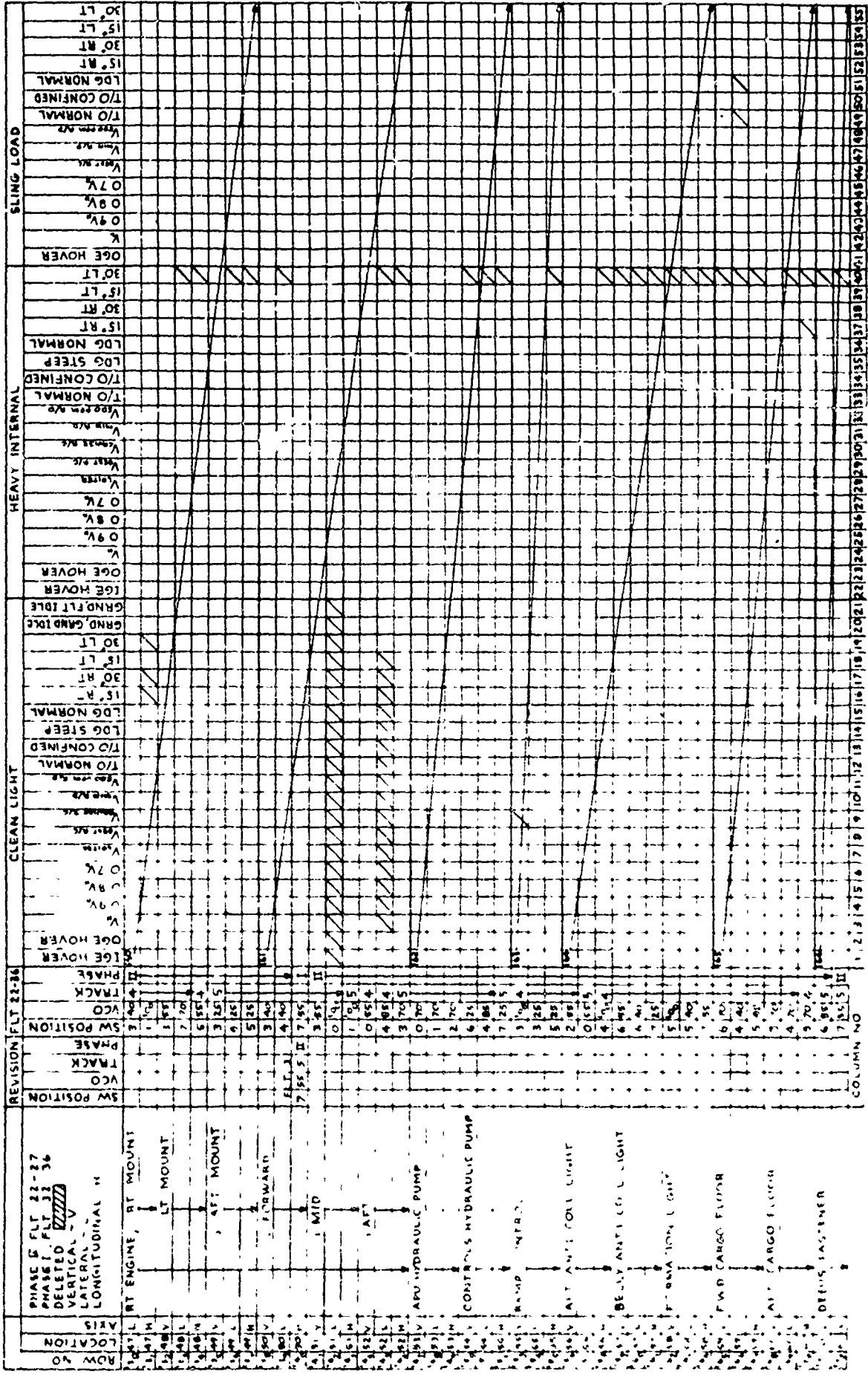

FIGURE 2
 SECOND PASS DATA COMPRESSION ARRAY
 CH-47C USA S/N 49-17126



**FIGURE 2
SECOND PASS DATA COMPRESSION ARRAY**

CH-47C USA S/N 69-17126



1 2 3 4 5 6 7 8 9 10 11 12 13 14 15 16 17 18 19 20 21 22 23 24 25 26 27 28 29 30 31 32 33 34 35 36 37 38 39 40 41 42 43 44 45 46 47 48 49 50 51 52 53 54 55
COLUMN NO

FIGURE 2
SECOND PASS DATA COMPRESSION ARRAY

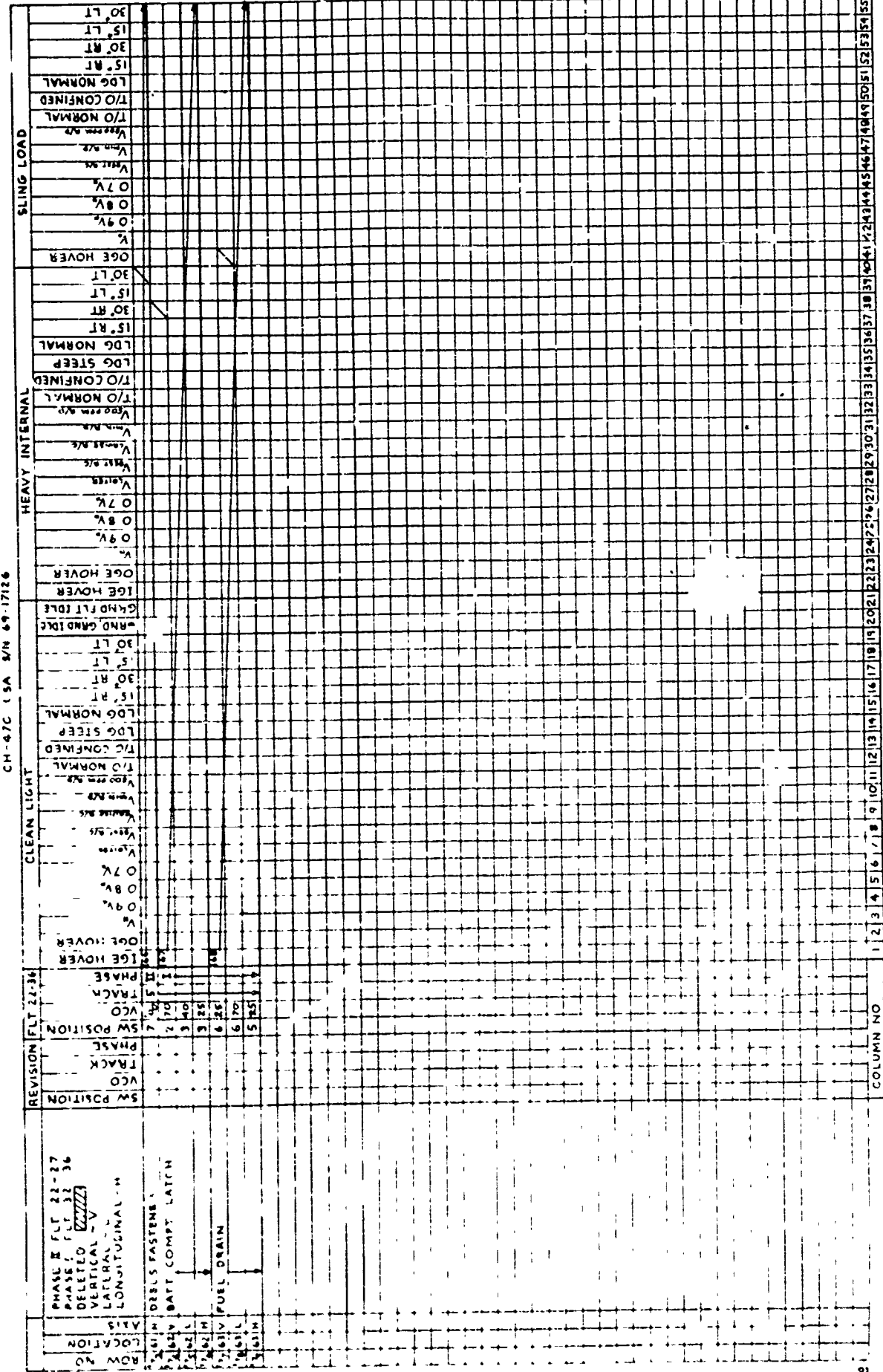

COLUMN NO 1 2 3 4 5 6 7 8 9 10 11 12 13 14 15 16 17 18 19 20 21 22 23 24 25 26 27 28 29 30 31 32 33 34 35 36 37 38 39 40 41 42 43 44 45 46 47 48 49 50 51 52 53 54 55

THIRD PASS DATA COMPRESSION ARRAY

PAGE 1 OF 1

CH. 4/C USA S/N 69-17126

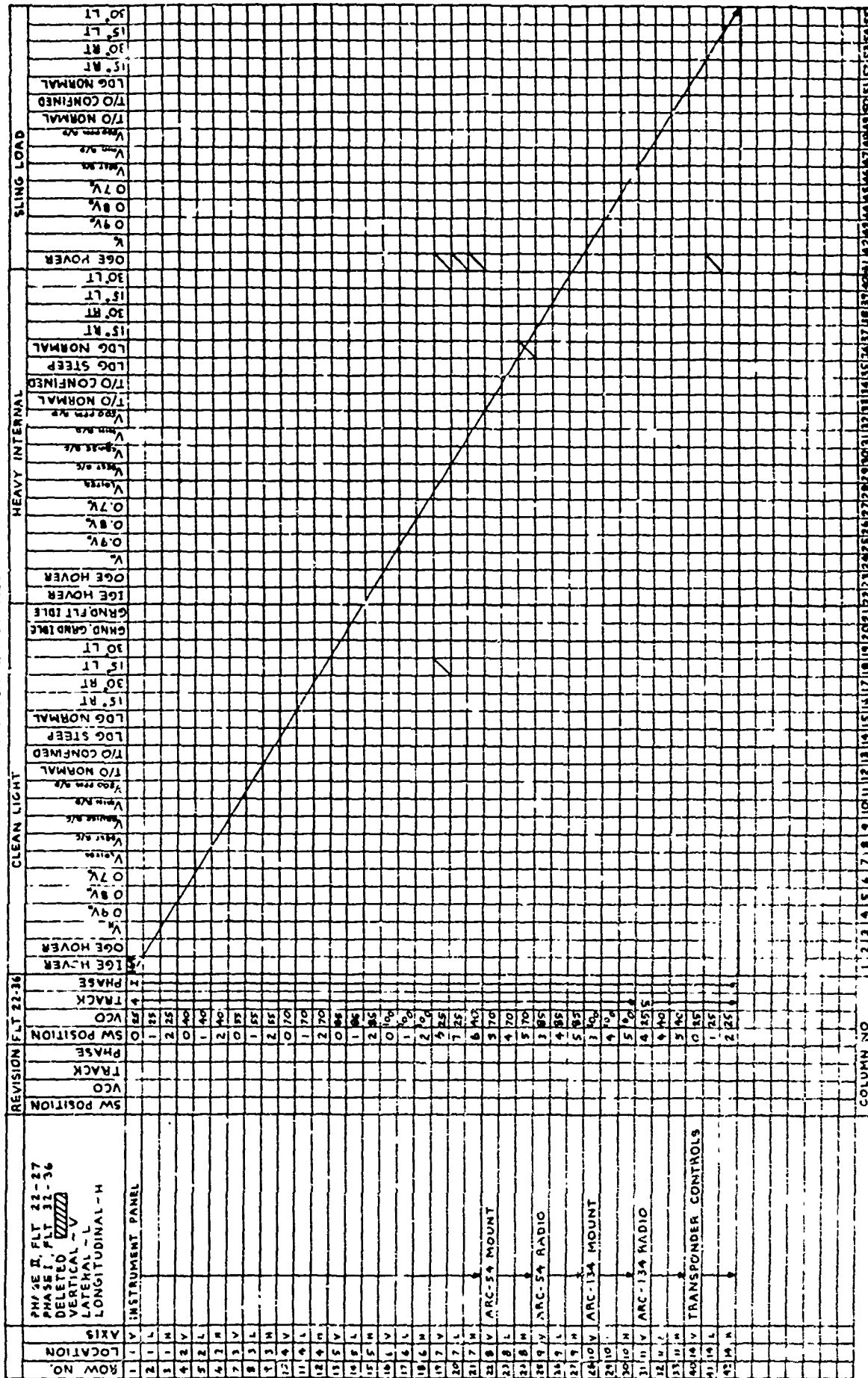

COMPRESSED VIBRATION DATA MAXIMUM ACCELERATION

FIG 4

CH-47C USA 8/N 69-17126
 A/C CONFIG-COMB CLEAN, SLING AND INTERNAL LOAD
 COMBINED FLT CONDITIONS
 INSTR PANEL COMB AXIS-SENSOR LOC 1, 2, 3, 4, 5, 6, 7
 COMPRESSION PASS NO. 2 VIB PLOT 148

CONDITIONS OF MAXIMUM ACCELERATIONS				COMPRESSION 148	
FREQUENCY %IZ	FLIGHT CONDITIONS	COMPIC	AXIS	LOCATION NUMBER	VIB AMPL %g
8	T/O E	MANOV	Y	3	1.51
74	LOS A	SLING LOAD	H	7	1.1
75	LF (VA)	MANOV	H	7	1.1
48	VIGN R/D	SLING LOAD	Y	6	1.1
124	T/O B	SLING LOAD	Y	1	1.1
149	T/O B	MANOV	Y	7	1.1
151	LF (VA)	MANOV	H	7	1.1
154	Y500 RFA R/D	MANOV	H	7	1.1
168	SL LT	SLING LOAD	Y	1	1.1
168	YEST R/C	SLING LOAD	Y	2	1.1

ONE HALF PEAK TO PEAK ACCELERATION G

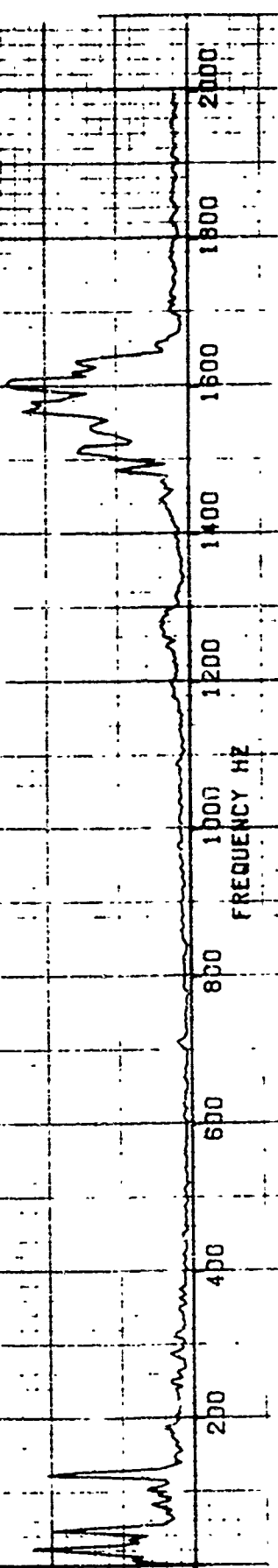
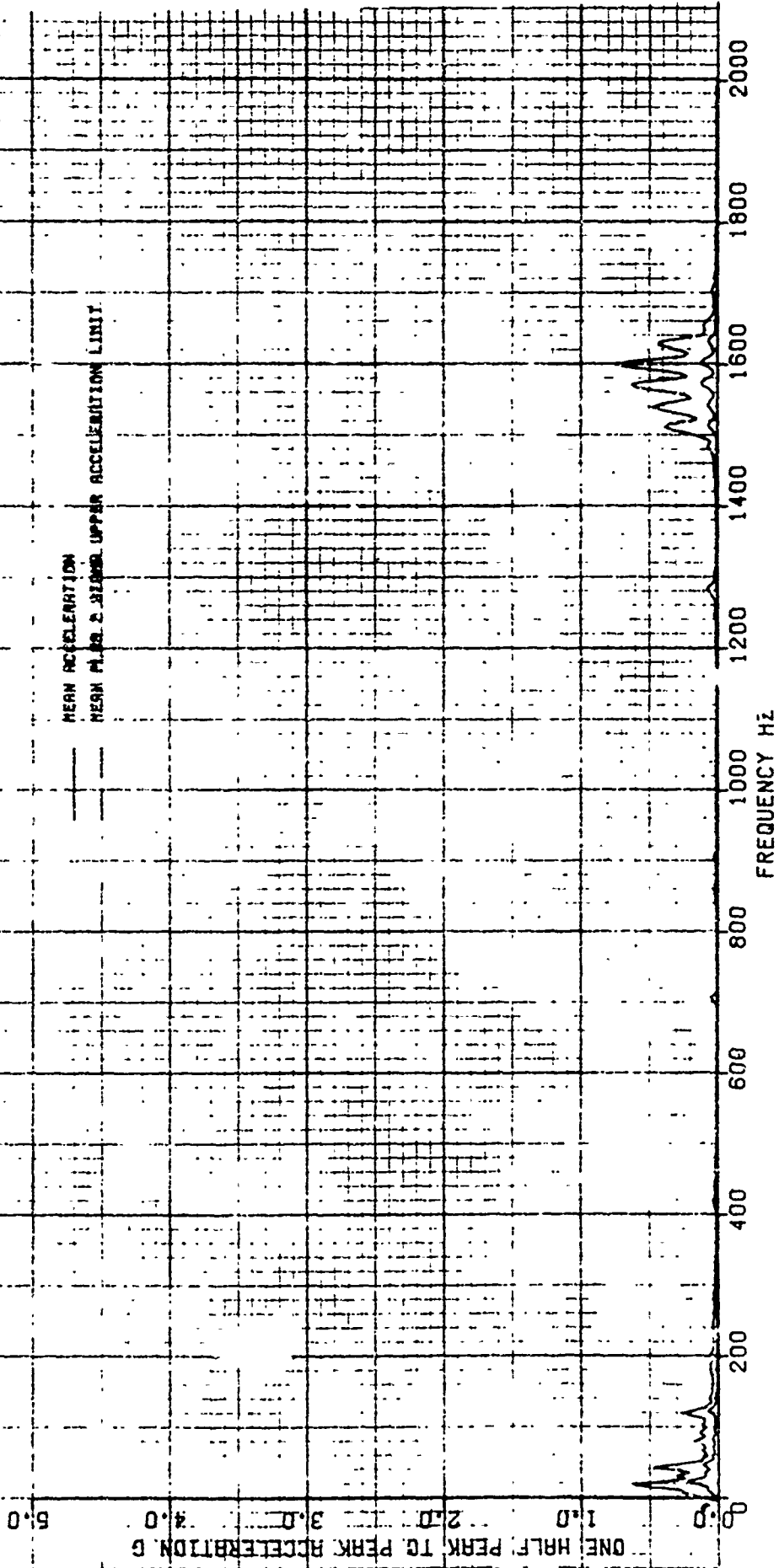

FIG 5
COMPRESSED VIBRATION DATA

CH-47C, USR 6/N 6B-17126
A/C CONFIG-COMB CLEAN, SLING AND INTERNAL LOAD
COMBINED FLT CONDITIONS
INSTR. PANEL COHB AXIS-SENSOR LOC 1.2.3.4.5.6.7
COMPRESSION PASS NO.2 VIB PLOT 14B



COMPRESSED VIBRATION DATA MAXIMUM ACCELERATION

FIG 6

CH-47C USB S/N 69-17126
 R/C CONFIG-COMB CLEAN, SLING AND INTERNAL LOAD
 COMBINED FLT CONDITIONS
 AVIONICS LOW FREQ EQUIP COMB. AXIS=SENSOR, LCC B. 8.10.11.14
 COMPRESSION PASS NO. 2 VIS PLOT 149

CONDITIONS OF MAXIMUM ACCELERATIONS			COMPRESSION 149		
FREQUENCY *HZ	FLIGHT CONDITIONS	COMPIS	AXIS	LOGSTIME MINUTES	VIB AMPL %g
12	LOG A	PARAZ	V	8	1.5
24	LOG A	Sling Load	V	14	1.5
48	LOG A	Sling Load	V	14	1.5
1200	T/O B	Sling Load	V	14	1.5
1400	PARAZ R/C	Sling Load	V	14	1.5
1500	Power (OG)	Sling Load	V	14	1.5
1572	LF (0.7 W)	Light	V	14	1.5
1600	LOG A	PARAZ	V	14	1.5
1640	V500 RPM R/O	Sling Load	V	14	1.5
1712	LF (0.8 W)	Light	V	14	1.5

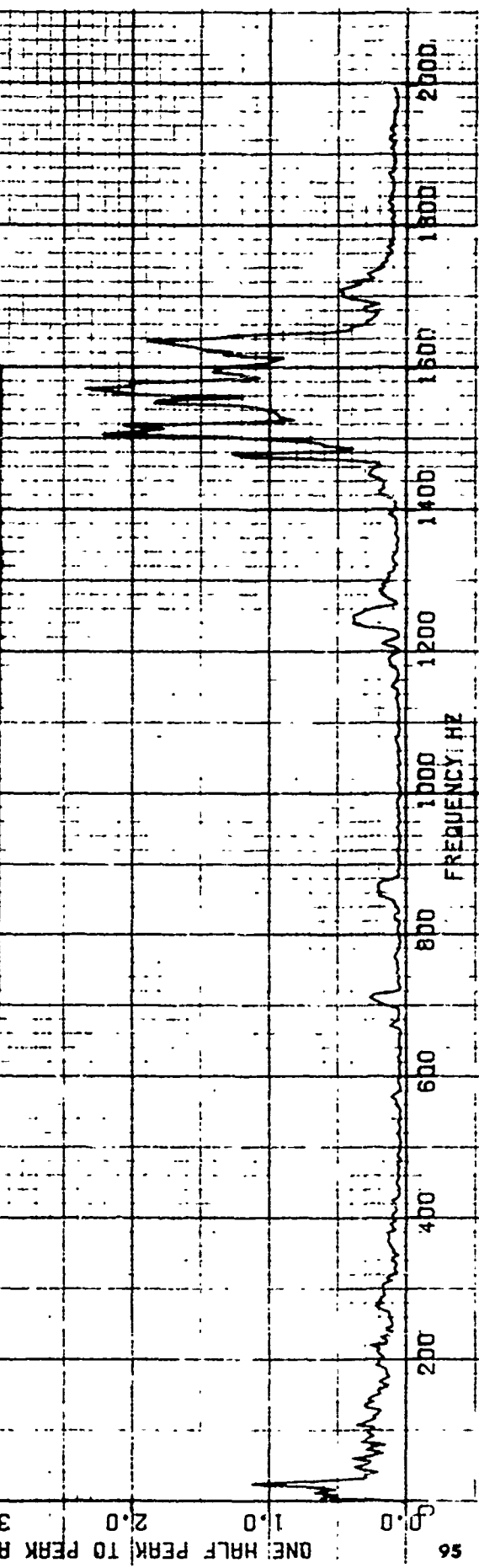

FIG 7
COMPRESSED VIBRATION DATA

CH-47C USA S/N 68-17126
R/C CONFIG--COMB CLEAN SLING AND INTERNAL LOAD
COMBINED FLT CONDITIONS
AVIONICS LOK FREQ EQUIP COMB AXIS--SENSOR LOC 8,9,10,11,14
COMPRESSION PASS NO.2 VIB PLOT 149

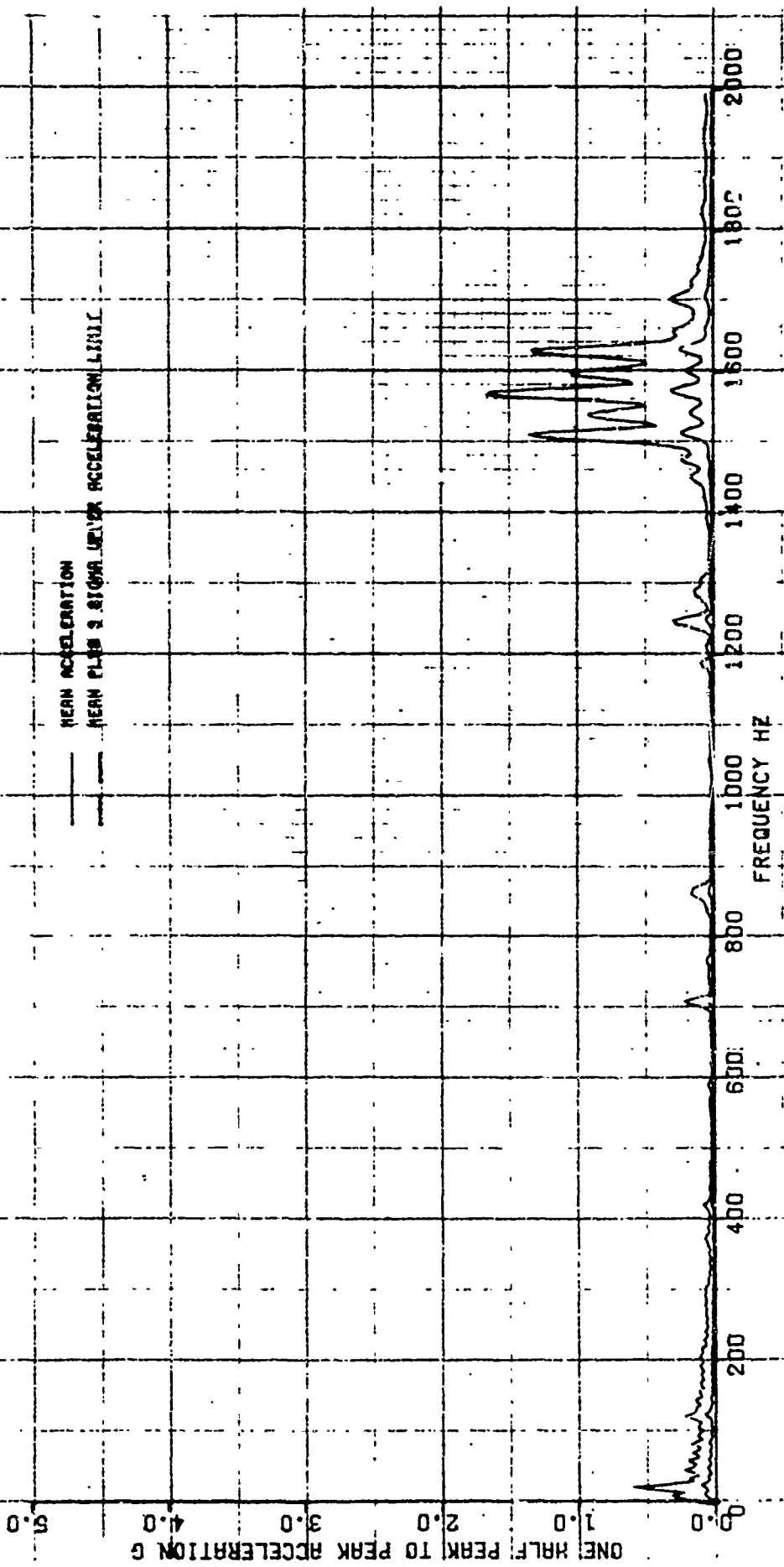

FIG 8
COMPRESSED VIBRATION DATA MAXIMUM ACCELERATION

CH-47C USR 6/N 69-17126
A/C CONFIG-COMB CLEAN, SLING AND INTERNAL LOAD
COMBINED FLT CONDITIONS
AVIONICS HIGH FREQ EQUIP COMB AKIS-SENSOR LOC 12.13
COMPRESSION PASS NO. 2 VIB PLOT 150

CONDITIONS OF MAXIMUM ACCELERATIONS				COMPRESSION	
FREQUENCY -HZ	FLIGHT CONDITIONS	CONFIG	AXIS	LOCATION NUMBER	VIB AMPL %
24	T/O A	MANVZ	L	13	1.7
48	LOC A	SLING LOAD	L	13	2.3
96	LOC A	SLING LOAD	L	13	2.8
144	15° RT	MANVZ	L	13	4.7
1248	15° RT	MANVZ	V	13	4.8
1480	T/O B	MANVZ	V	13	4.8
1512	T/O B	MANVZ	V	13	4.8
1572	LF (V-SLTER)	MANVZ	V	13	4.8
1604	DOWN 8/H	SLING LOAD	V	13	4.8
1632	15° RT	MANVZ	V	13	4.8

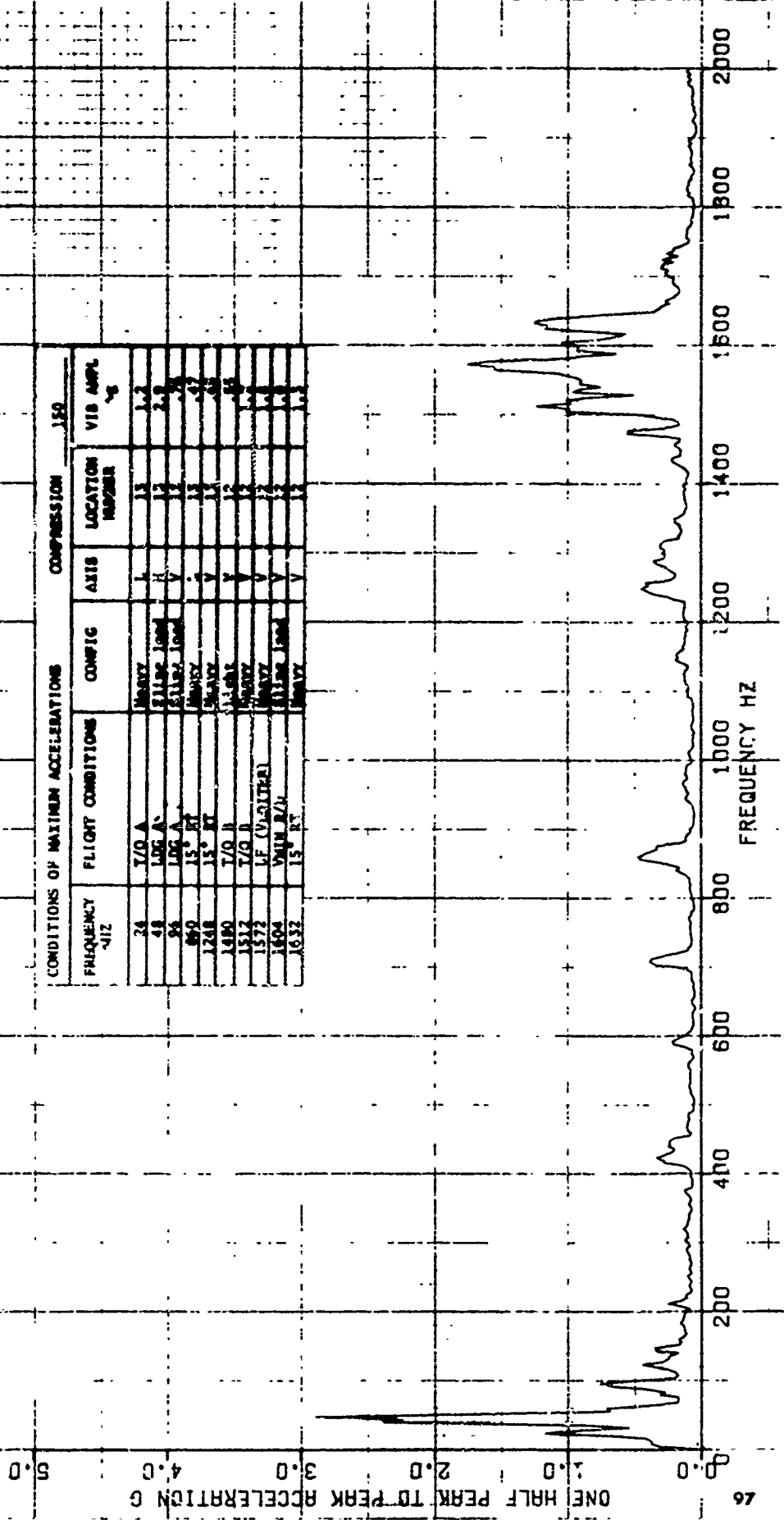

FIG 9
COMPRESSED VIBRATION DATA

CH-47C USA S/N 68-17126
A/C CONFIG-COMB CLEAN, SLING AND INTERNAL LOAD
AVIONICS HIGH FREQ EQUIP COMB AXIS-SENSOR LOC 12,13
COMPRESSION PASS NO.2 VIB PLOT 15D

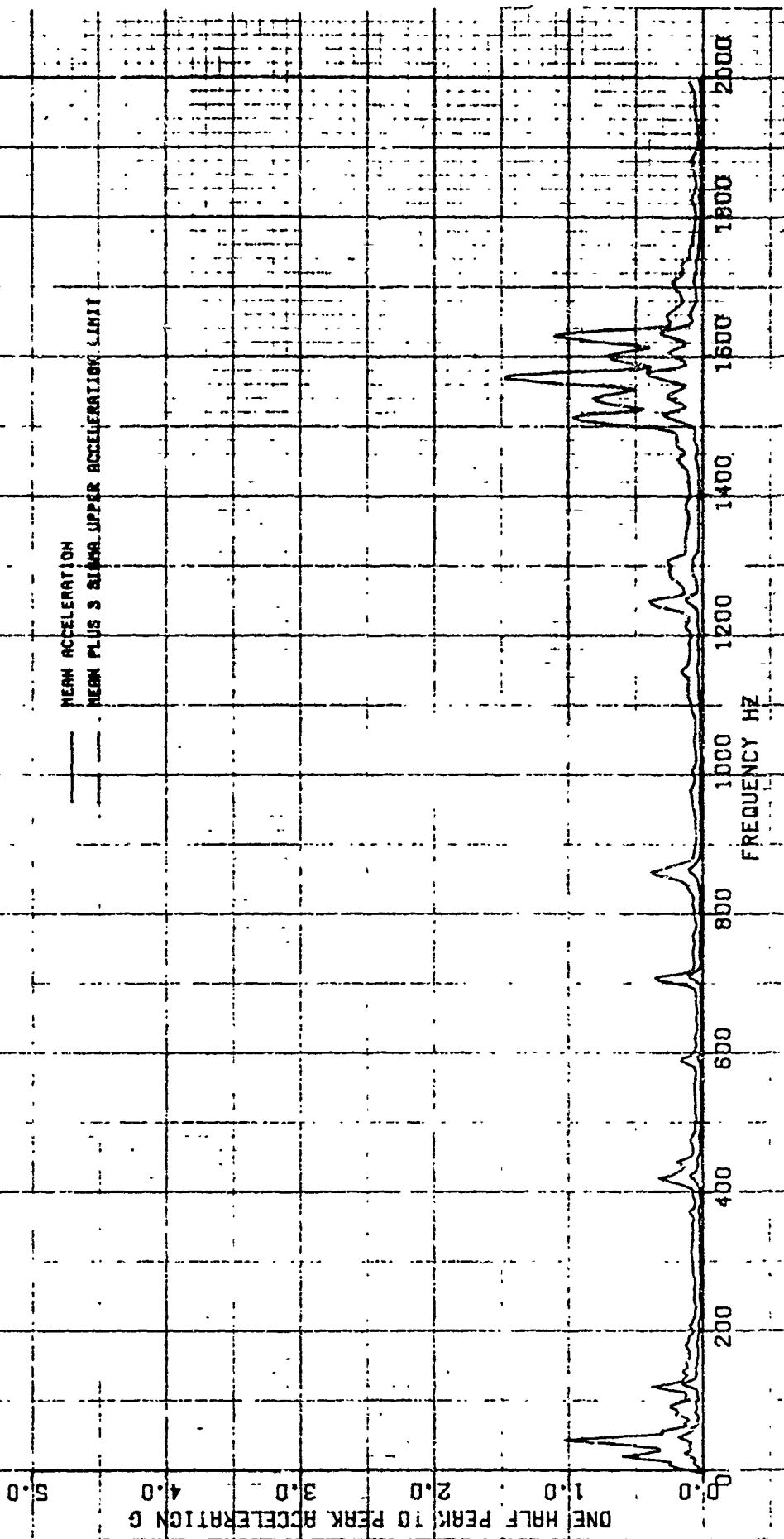
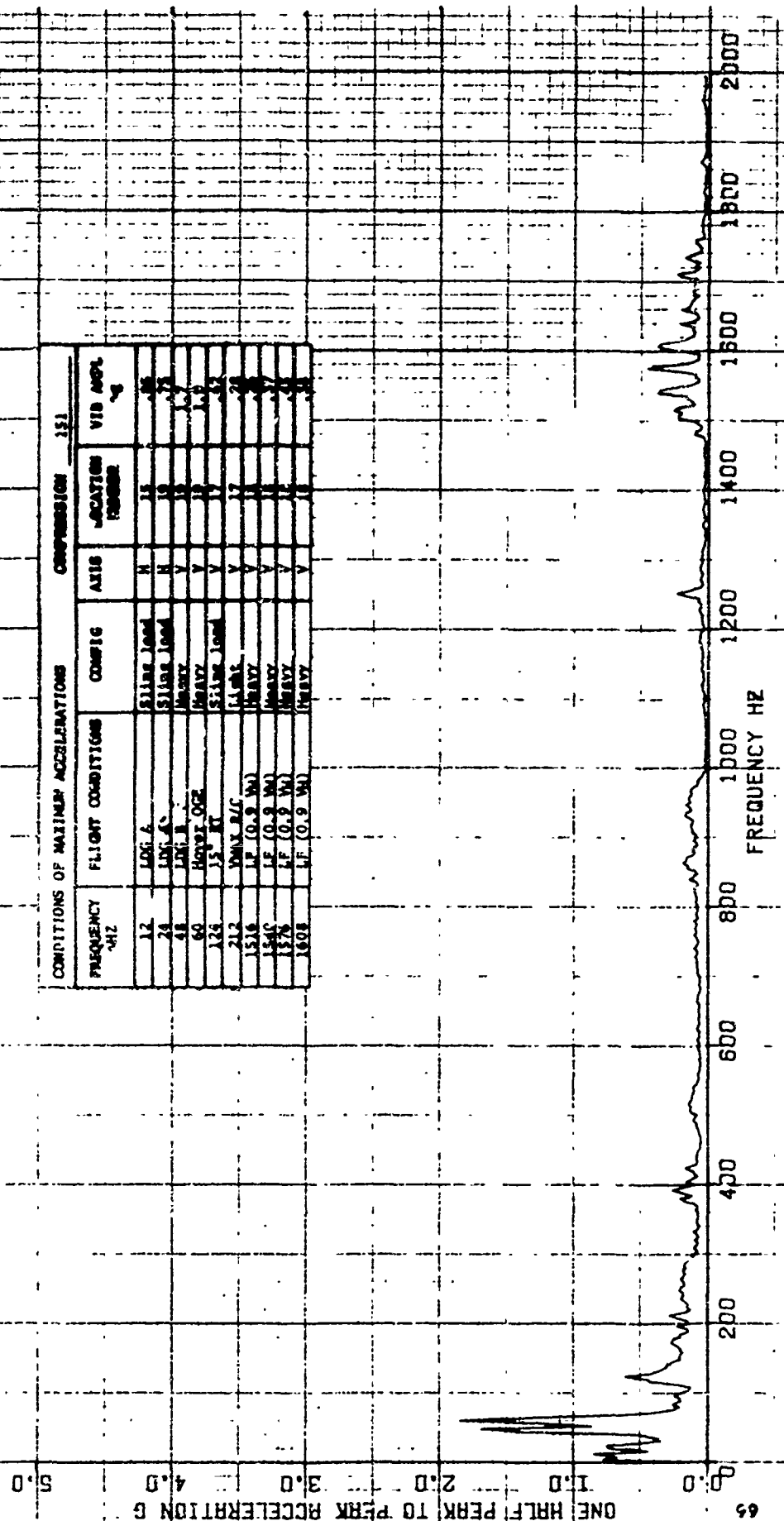

FIG 10 COMPRESSED VIBRATION DATA MAXIMUM ACCELERATION

CH-47C USA E/N 68-17126
A/C CONFIG-COMB CLEAN SLING AND INTERNAL LOAD
COMBINED FLT CONDITIONS
PILOT AREA VIB INPUT COMB AXIB-SENSOR LOC 15,16,17,18,19
COMPRESSION PSS8 NO.2 VIB PLOT 151



CONDITIONS OF MAXIMUM ACCELERATIONS			COMPRESSION 151		
FREQUENCY HZ	FLIGHT CONDITIONS	CONFIG	AXIS	LOCATION NUMBER	VIB AMPL g
12	LINE A	SLING LOAD	H	15	4.5
24	LINE A	SLING LOAD	H	15	4.5
48	LINE B	WARY	V	15	4.5
60	POWER OFF	WARY	V	15	4.5
120	15 FT	SLING LOAD	V	15	4.5
212	MAX R/C	WARY	V	15	4.5
1516	LF (0.9 W)	WARY	V	15	4.5
1540	LF (0.9 W)	WARY	V	15	4.5
1576	LF (0.9 W)	WARY	V	15	4.5
1608	LF (0.9 W)	WARY	V	15	4.5

FIG II

COMPRESSED VIBRATION DATA

CH-47C USA S/N 68-17126
A/C CONFIG-COMB CLEAN SLING AND INTERNAL LOAD
COMBINED FLT CONDITIONS
PILOT AREA VIB INPUT COMB AXIS-SENSOR LDC 15, 16, 17, 18, 19
COMPRESSION PASS NC-2 VIB PLOT 151

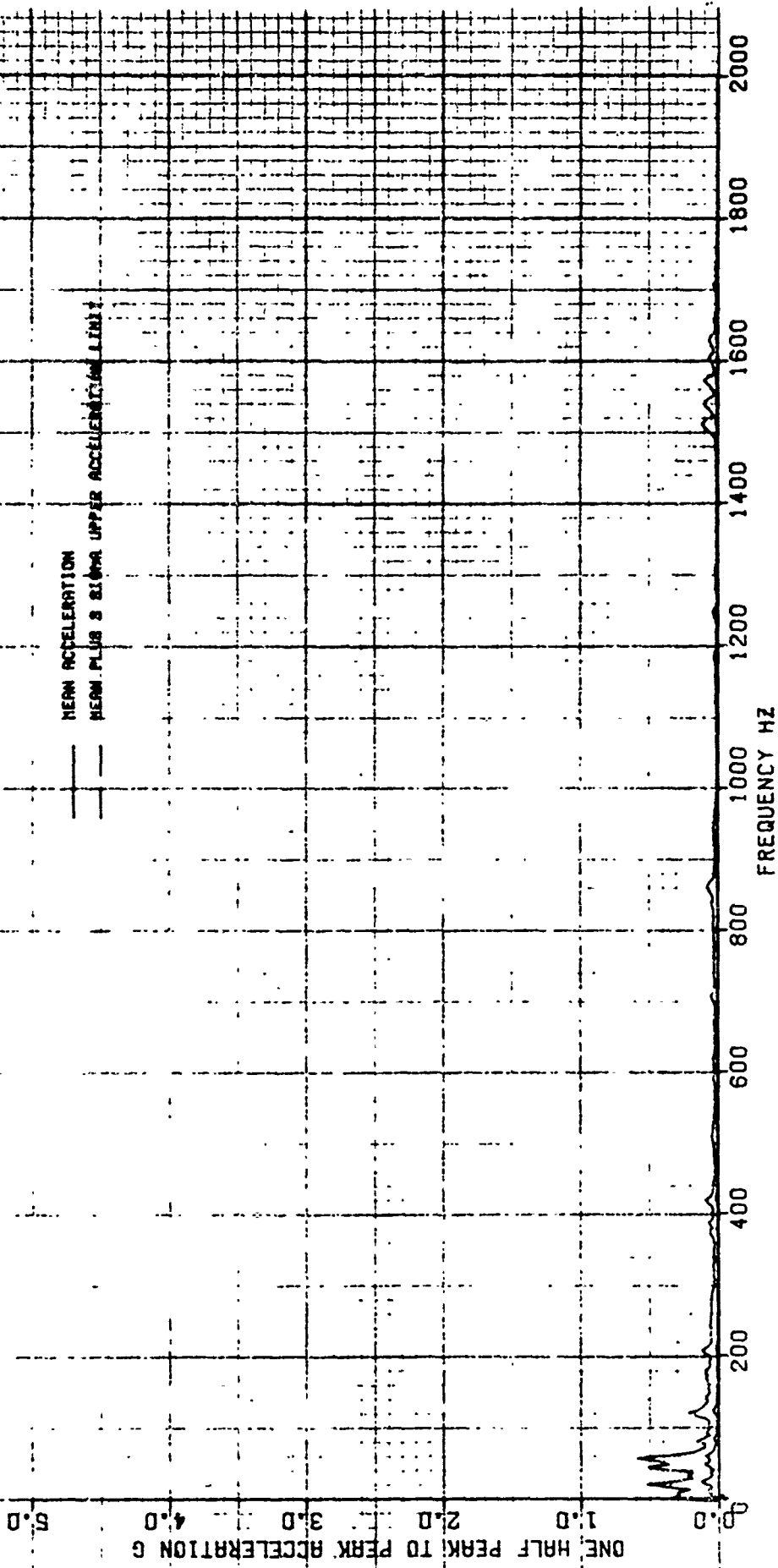

FIG 12 COMPRESSED VIBRATION DATA MAXIMUM ACCELERATION

CH-47C USA S/N. 88-17126
R/C CONFIG-COMB CLEAN, SLING AND INTERNAL LOAD
COMBINED FLT CONDITIONS
PILOT OUTPUT VIB COMB AXIS-SENSOR LOC 20.21
COMPRESSION PASS NO. 2 VIB PLOT 152

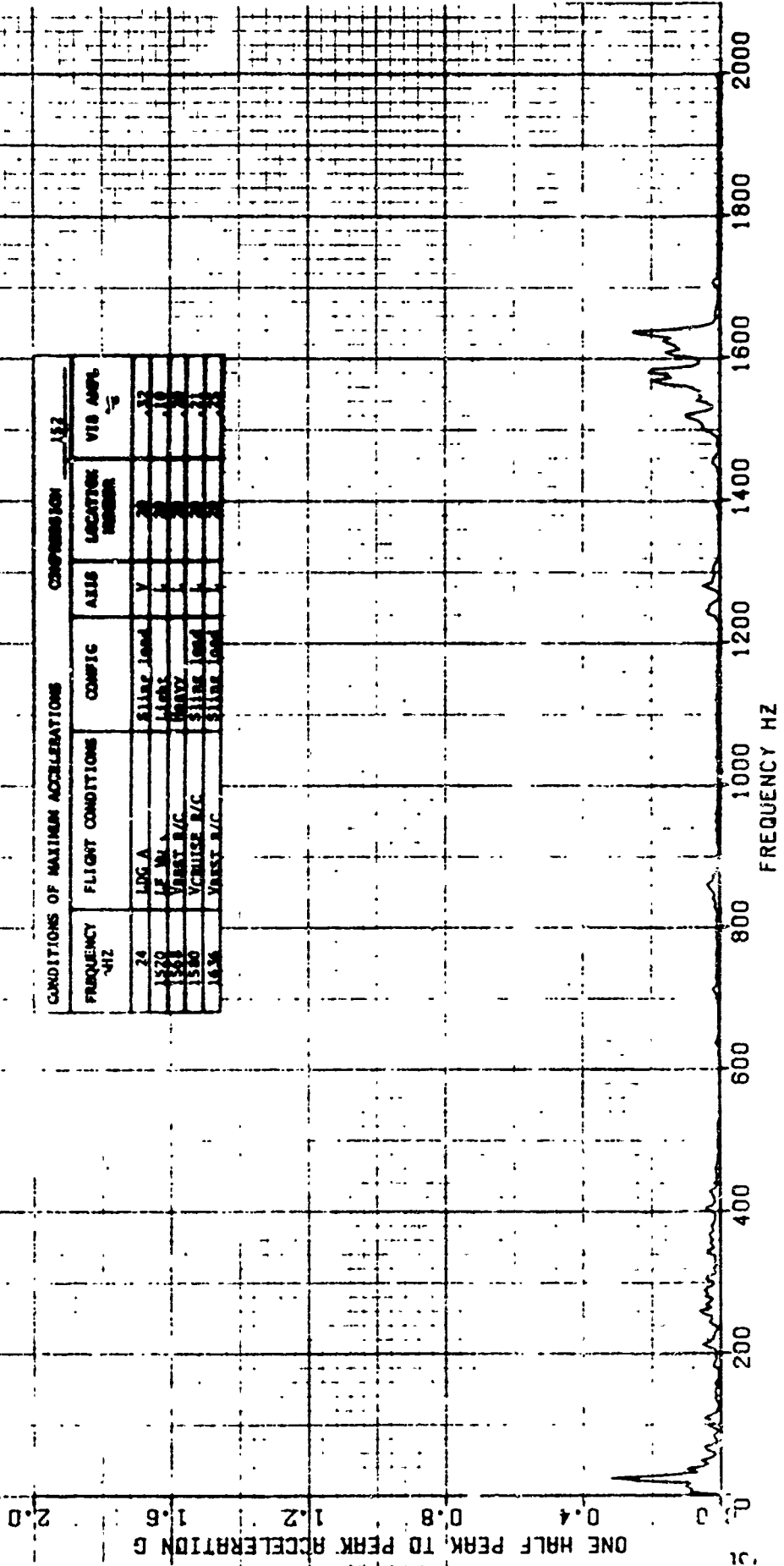

FIG 13
COMPRESSED VIBRATION DATA

CH-47C USA S/N 82-17126
A/C CONFIG-COMB CLEAN, SLING AND INTERNAL LOAD
COMBINED FLT CONDITIONS
PILOT OUTPUT VIB COMB AXIS-SENSOR LOC 20.21
COMPRESSION PASS NO.2 VIB PLOT 152

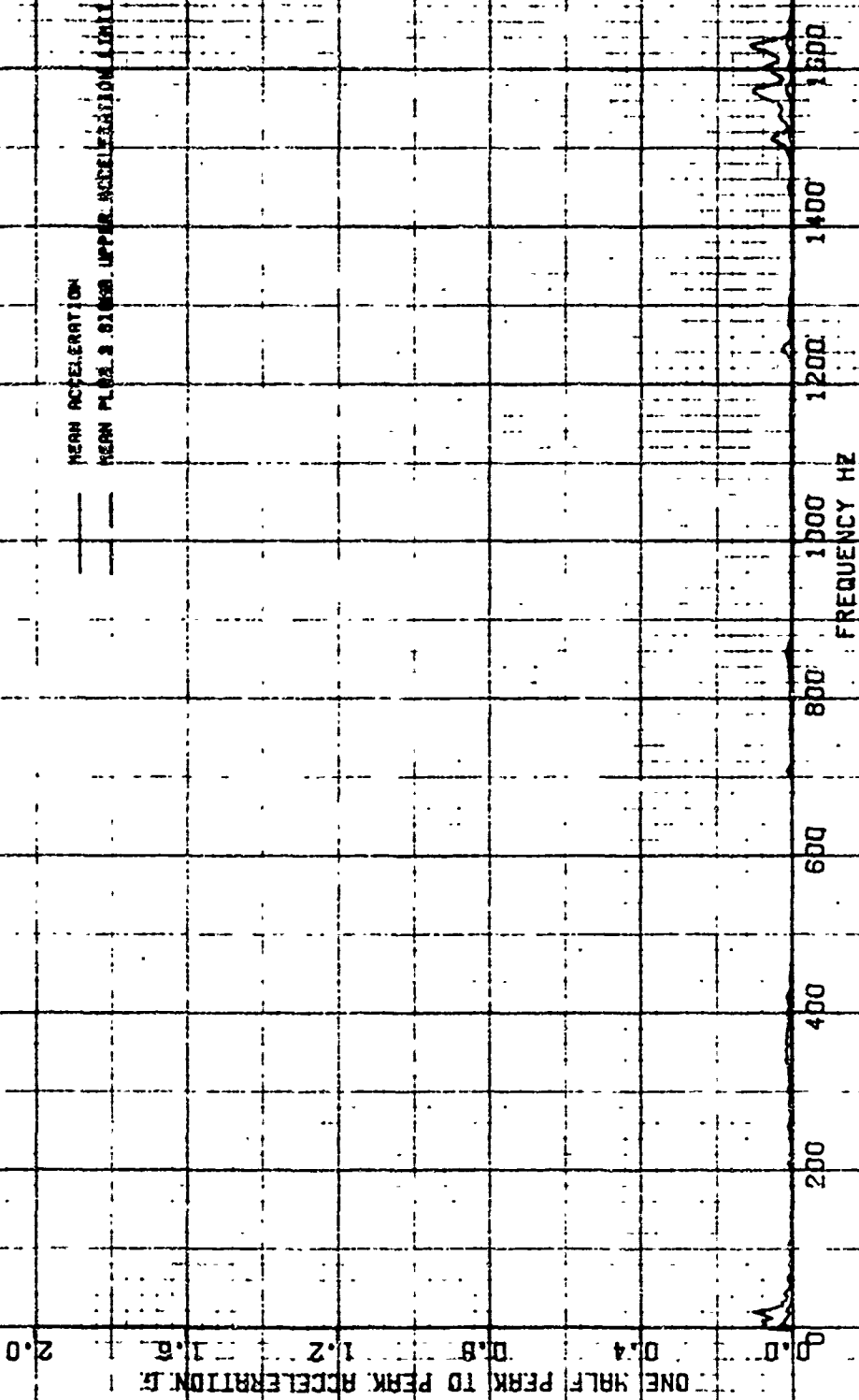
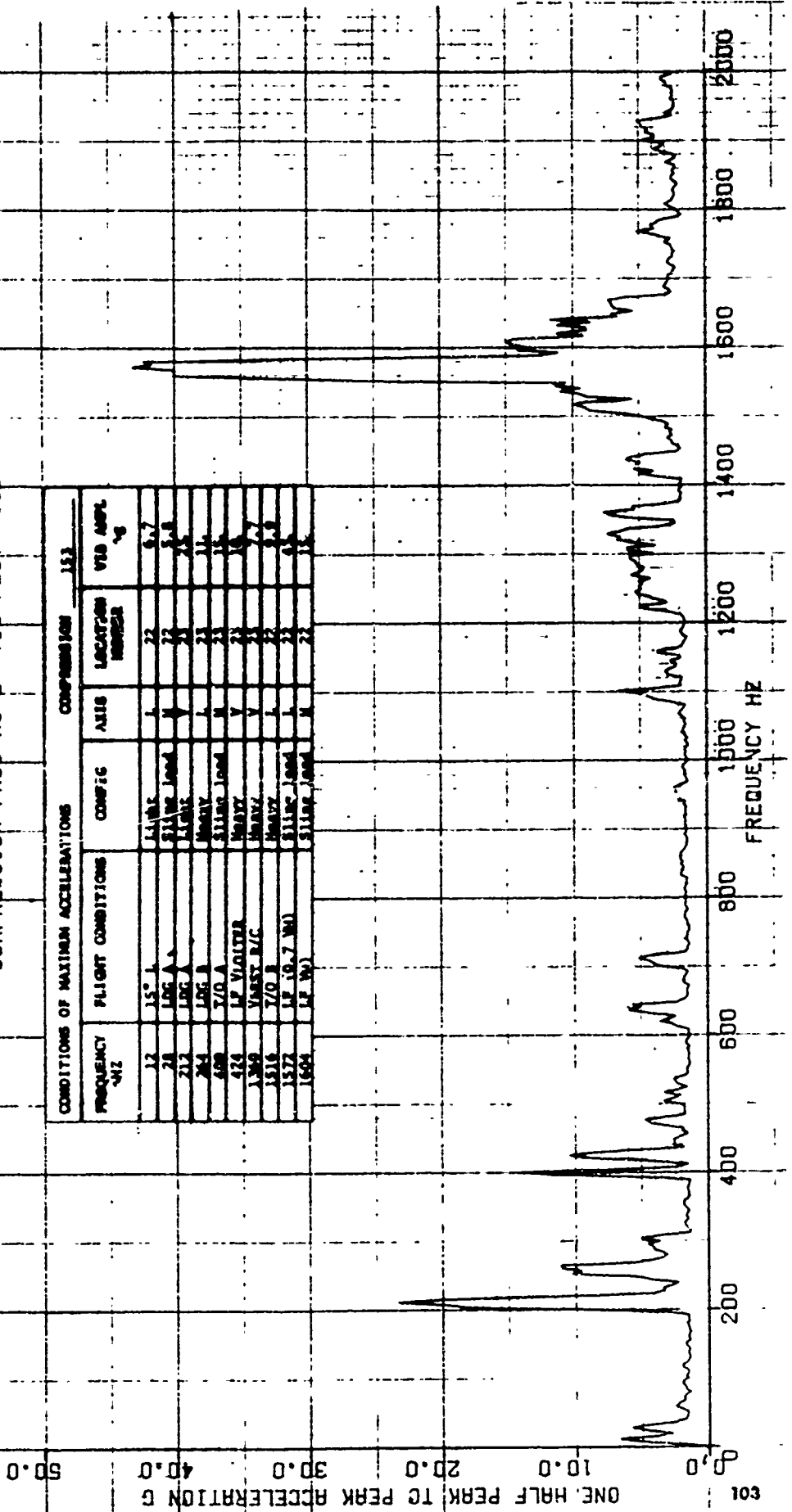

FIG 14 COMPRESSED VIBRATION DATA MAXIMUM ACCELERATION

CH-47C US8 6/N 68-17126
R/C CONFIG-COMB CLEAN SLING AND INTERNAL LOAD
COMBINED FLT CONDITIONS
TACH GENERATORS COMB AXIS-SENSOR LOC 22.23
COMPRESSION PASS NO.2 VIB PLOT 15B

CONDITIONS OF MAXIMUM ACCELERATIONS				COMPRESSION 15B	
FREQUENCY -HZ	FLIGHT CONDITIONS	CONFIG	AXIS	LOCATION NUMBER	VIB AMPL -g
12	15° L	L1VLC	L	22	6.7
28	LOG A	Sling Load	V	22	8.8
212	LOG A	SLING	V	22	25.8
264	LOG A	WAVY	L	22	11
408	T/O A	Sling Load	H	22	11
476	LP VALTER	WAVY	V	22	15
1368	VNAST R/C	WAVY	V	22	17.7
1516	T/O B	WAVY	L	22	11.8
1572	LP (0.7 W)	Sling Load	L	22	11
1604	LP (W)	Sling Load	L	22	11



COMPRESSED VIBRATION DATA MAXIMUM ACCELERATION

FIG 16

CH-47C USA S/N 68-17126
 A/C CONFIG-COMB CLEAN, SLING AND INTERNAL LOAD
 COMBINED FLT CONDITIONS
 FWD TRANS MOUNTS COMB AXIS-SENSOR LDC 24, 25, 26, 27
 COMPRESSION PASS NO. 2 VIF PLOT 154

CONDITIONS OF MAXIMUM ACCELERATIONS				COMPRESSION 154	
FREQUENCY HZ	FLIGHT CONDITIONS	CONFIG	AXIS	LOCATION NUMBER	VIB AMPL %g
704	T/O A	HEAVY	V	26	1.4
872	Hover OGE	HEAVY	V	27	1.4
1244	T/O A	HEAVY	V	27	2.7
1244	Hover OGE	HEAVY	V	27	2.3
1468	T/O B	HEAVY	H	24	2.1
1516	Hover OGE	HEAVY	V	27	2.7
1544	VSOB EFM R/O	SLING	V	27	1.6
1572	VREST R/C	HEAVY	H	25	1.6
1628	Hover OGE	SLING load	V	27	1.4
1704	LF (O & VA)	SLING load	V	27	2.4

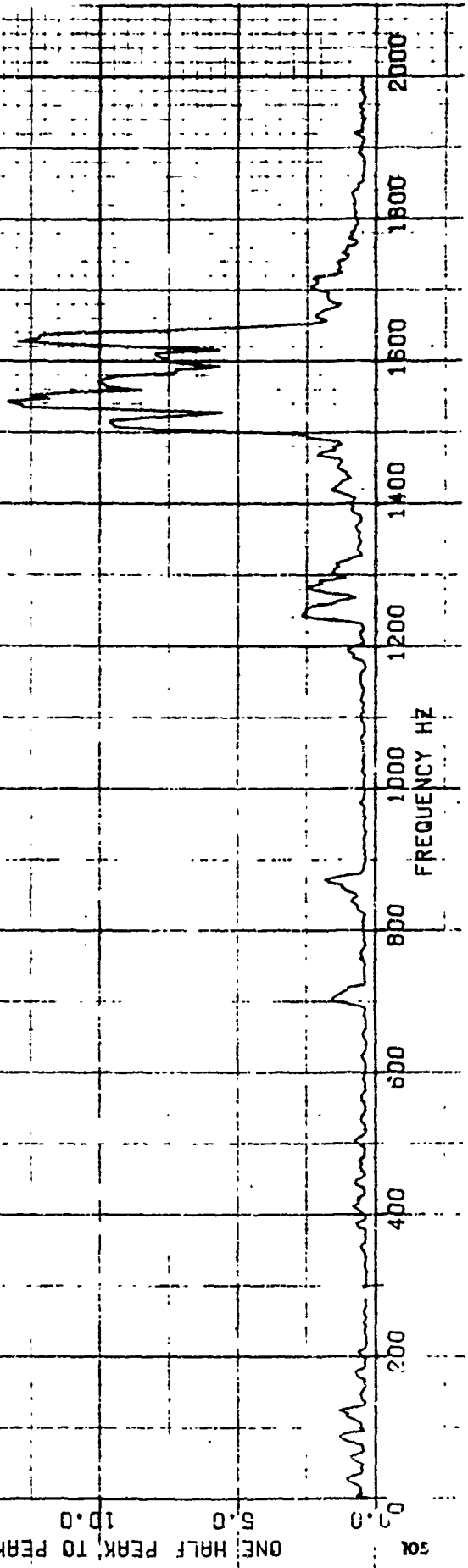

FIG 17
COMPRESSED VIBRATION DATA

CH-47C USA S/N 69-17126
A/C CONFIG-COMB CLEAN, SLING AND INTERNAL LOAD
COMBINED FLT CONDITIONS
FWD TRANS MOUNTS COMB AXIS-SENSOR LOC 24.25.26.27
COMPRESSION PASS NO.2 VIB PLOT 15*

MEAN ACCELERATION
MEAN PLUS 3 SIGMA UPPER ACCELERATION LIMIT

ONE HALF PEAK TO PEAK ACCELERATION G
25.0
20.0
15.0
10.0
5.0
0.0

FREQUENCY HZ
200
400
600
800
1000
1200
1400
1600
1800
2000

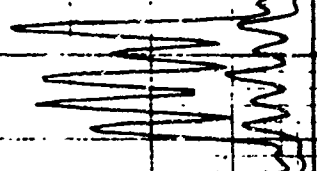

FIG 18 COMPRESSED VIBRATION DATA MAXIMUM ACCELERATION

CH-47C USA 6/N 69-17126
A/C CONFIG-COMB CLEAN, SLING AND INTERNAL LOAD
COMBINED FLT CONDITIONS
AFT TRANS MOUNTS COMB AX16-SENSOR LDC 28, 29, 30, 31
COMPRESSION PASS NO. 2 VIB PLOT 155

CONDITIONS OF MAXIMUM ACCELERATIONS					COMPRESSION	
FREQUENCY -HZ	FLIGHT CONDITIONS	CONFIG	AXIS	LOCATION NUMBER	VIB AMPL -g	
32	LDC A	SLING LOAD	H	31	1.8	
60	15° A	SLING LOAD	H	31	2.4	
864	T/O B	HEAVY	V	31	2.7	
1248	T/O B	SLING LOAD	V	31	2.9	
1512	GRND (FLT IDLE)	LIGHT	V	31	1.4	
1532	VAERT B/C	CLEAR	V	31	2.8	
1576	LE (0.9 YR)	HEAVY	V	31	2.7	
1628	T/O A	SLING LOAD	V	31	1.4	
1672	15° LT	LIGHT	V	31	1.4	
1732	VAERT B/C	HEAVY	V	31	1.8	

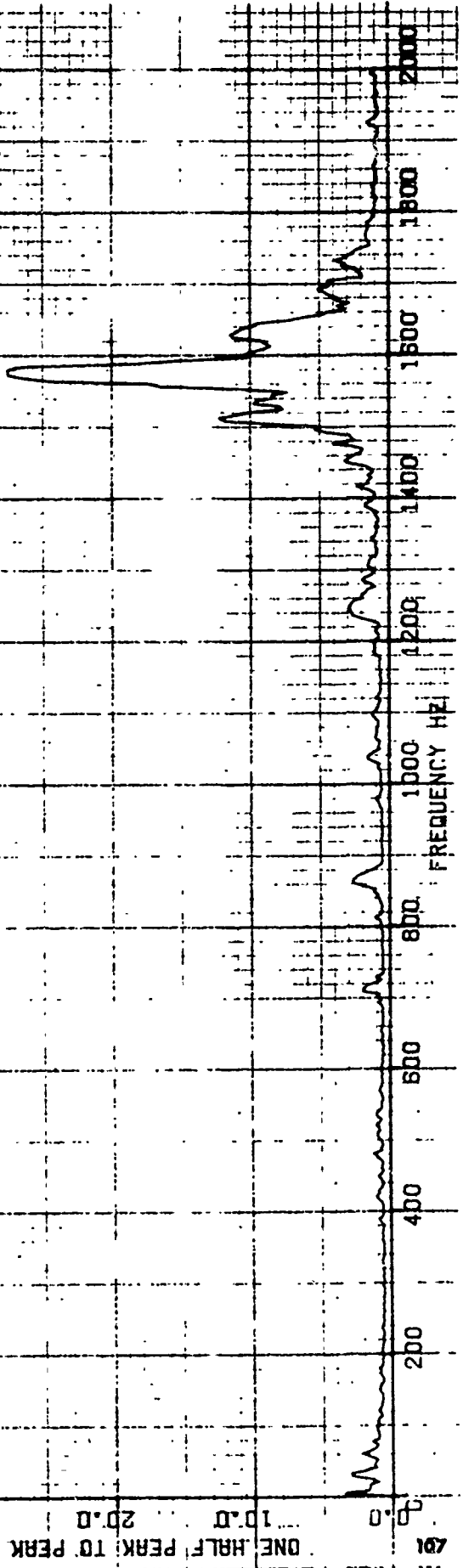

FIG 19
COMPRESSED VIBRATION DATA

CH-47C USA S/N 68-17126
R/C CONFIG-COMB CLEAN, SLING AND INTERNAL LOAD
COMBINED FLT CONDITIONS
AFT TRANS MOUNTS COMB AXIS-SENSOR LDC 28, 29, 30, 31
COMPRESSION PASS NO. 2 VIB PLOT 155

MEAN ACCELERATION
MEAN (CLIM 3) AT LOWEST PEAK ACCELERATION (MIN)

ONE HALF PEAK TO PEAK ACCELERATION G
50.0
40.0
30.0
20.0
10.0
0.0

200 400 600 800 1000 1200 1400 1500 1800 2000
FREQUENCY HZ

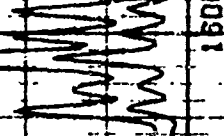

FIG 20 COMPRESSED VIBRATION DATA MAXIMUM ACCELERATION

CH-47C USA B/N 69-17126
R/C CONFIG-COMB CLEAN, SLING AND INTERNAL LOAD
COMBINED FLT CONDITIONS
HANGER BRGS COMB AXIS-SENSOR LOC 92, 38, 34, 86, 36, 37, 38
COMPRESSION PASS NO. 2 VIB PLOT 156

CONDITIONS OF MAXIMUM ACCELERATIONS				COMPRESSION	
FREQUENCY -412	FLIGHT CONDITIONS	CONFIG	AXIS	LOCATION NUMBER	VIB AMPL %
12	30° LT	LIGHT	L	3	10
134	T/O B	Sling Load	L	3	7.4
218	YDN B/O	LIGHT	L	3	7.4
376	CMD (FLT IDLE)	LIGHT	Y	3	6.9
1224	LP (HOLTER)	Heavy	L	3	6.9
1248	LP (WOLTER)	Sling Load	L	3	6.9
1352	LDG A	Heavy	L	3	7.7
1572	LDG A	Sling Load	L	3	15
1636	LDG A	LIGHT	L	3	15
1688	T/O A	LIGHT	L	3	15.3

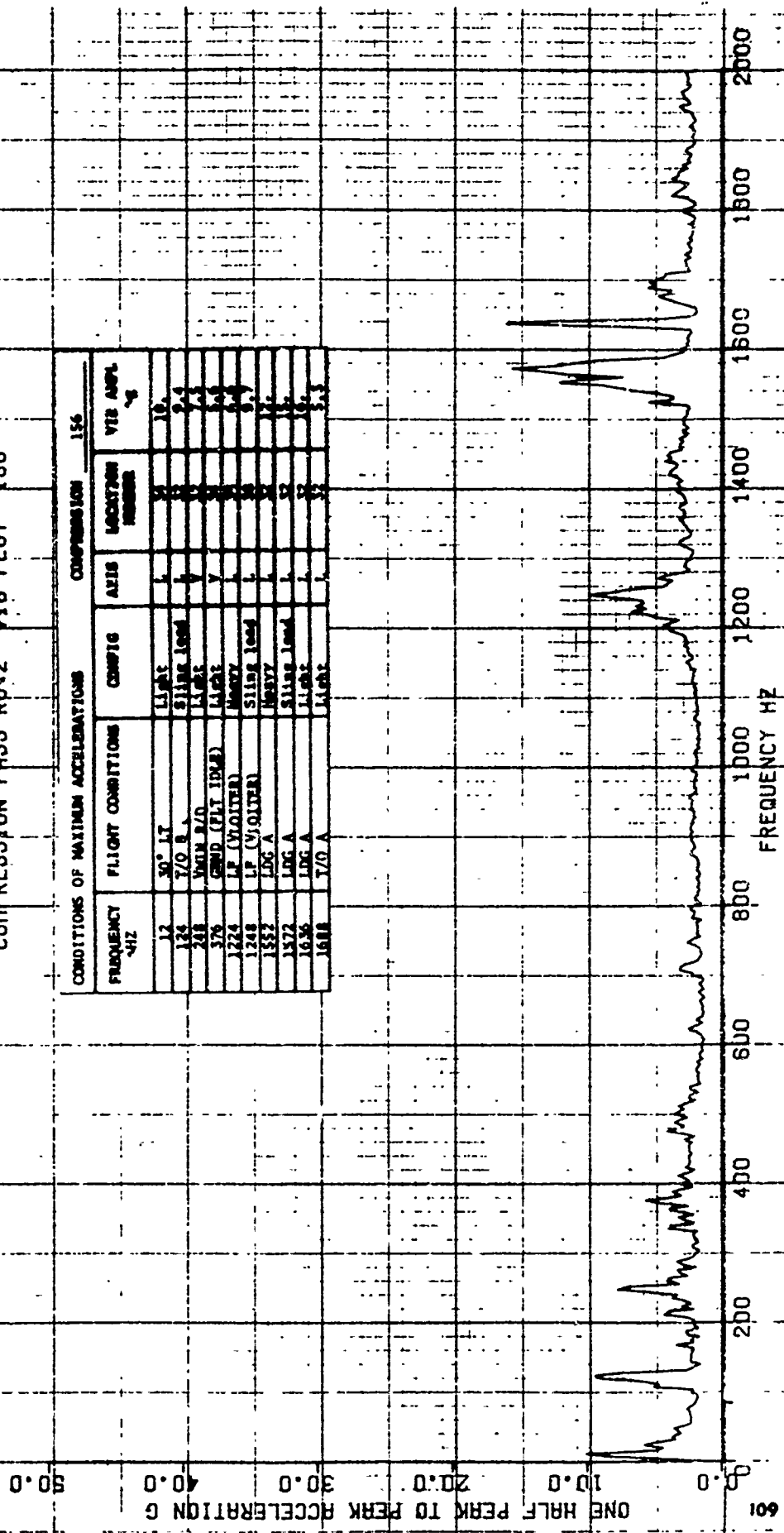

FIG 21 COMPRESSED VIBRATION DATA

CH-47C USA S/N 68-17126
 A/C CONFIG-COMB CLEAN SLING AND INTERNAL LOAD
 COMBINED FLT CONDITIONS
 HANGER BRGS COMB AXIS-SENSOR LOC. 32.39, 34.85, 36.37, 38
 COMPRESSION PASS NO.2 VIB PLOT 356

50.0

40.0

30.0

20.0

10.0

0.0

ONE HALF PEAK TO PEAK ACCELERATION G

MEAN ACCELERATION
 MEAN PLUS 3 SIGMA UPPER ACCELERATION LIMIT

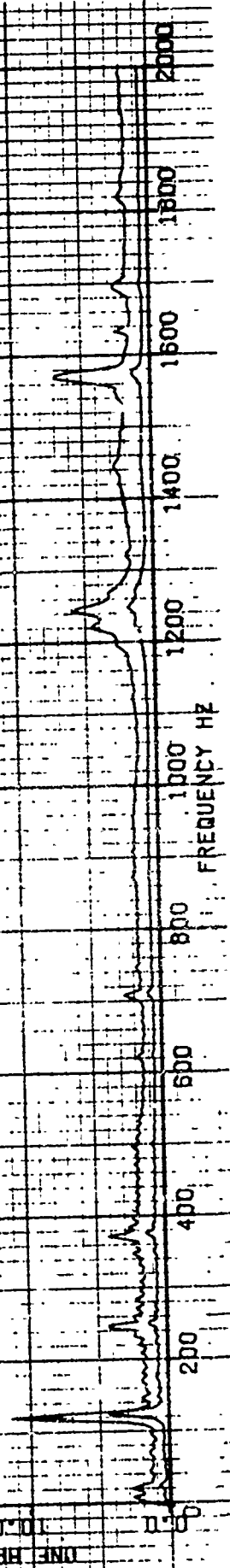

FIG 22 COMPRESSED VIBRATION DATA MAXIMUM ACCELERATION

CH-47C USAF S/N 69-17126
A/C CONFIG-COMB CLEAN, SLING AND INTERNAL LOAD
COMBINED FLT CONDITIONS
ACTUATORS COMB AXIS-SENSOR LOC 89,40,41,42
COMPRESSION PASS NO.2 VIB PLOT 157

CONDITIONS OF MAXIMUM ACCELERATIONS COMPRESSION 157

FREQUENCY Hz	FLIGHT CONDITIONS	CONFIG	AXIS	LOCATION NUMBER	VIB AMPL %
26	T/O A	SLING LOAD	X	41	13.2
84	LP (G.P. W)	SLING LOAD	X	41	8.7
104	W/T	SLING LOAD	X	41	7.3
212	15° BT	SLING LOAD	X	41	7.8
424	15° BT	SLING LOAD	X	41	11.1
636	15° BT	SLING	Y	41	7.1
1248	15° BT	SLING	Y	41	5.6
1544	LP (VOLTAGE)	EMPTY	Y	41	8.8
1576	VEHICLE B/C	EMPTY	X	41	16.1
1832	T/O B	SLING	Y	41	11.1

100.0
80.0
60.0
40.0
20.0
0.0
ONE HALF PEAK TO PEAK ACCELERATION G

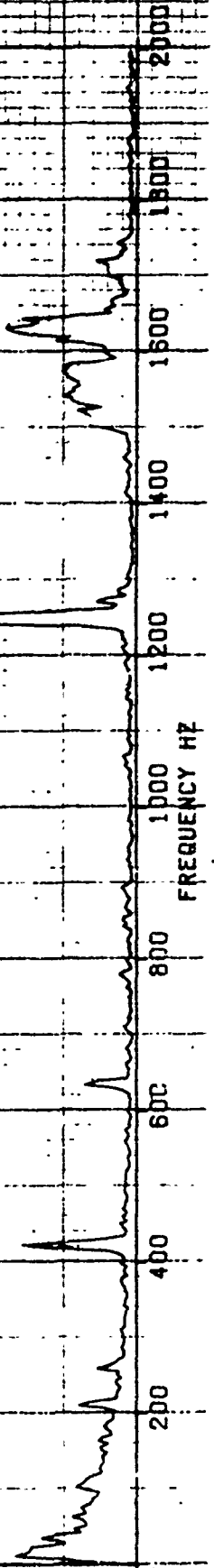

FIG 23

COMPRESSED VIBRATION DATA

CH-47C USA S/N 68-17126
A/C CONFIG-COMB CLEAN, SLING AND INTERNAL LOAD
COMBINED FLT. CONDITIONS
ACTUATORS COMB AKIS-SENSOR, LOC 39.40.41.42
COMPRESSION PASS NO.2 VIB PLOT 157

— MEAN ACCELERATION
— MEAN PLUS 3 SIGMA UPPER ACCELERATION LIMIT

21

ONE HALF PEAK TO PEAK ACCELERATION G
100.0
80.0
60.0
40.0
20.0
0.0

FREQUENCY HZ
200 400 600 800 1000 1200 1400 1600 1800 2000

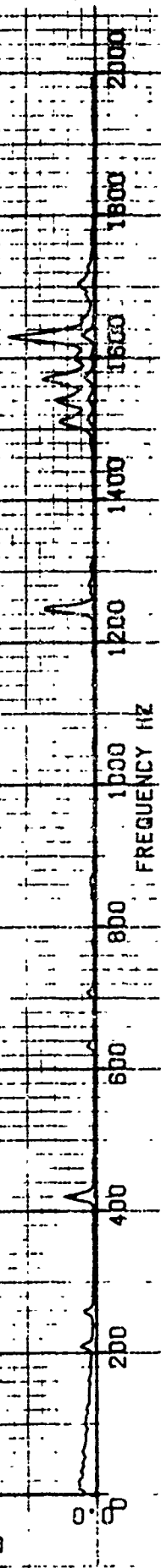

FIG 24 COMPRESSED VIBRATION DATA MAXIMUM ACCELERATION

CH-47C USA B/N 68-17126
R/C CONFIG-COMB CLEAN, SLING AND INTERNAL LOAD
COMBINED FLT CONDITIONS
COMB GEARBOXES COMB AX18-SENSOR LOC 43.44.45
COMPRESSION PASS NO.2 VIB PLOT 163

100.0

50.0

40.0

20.0

0.0

ONE HALF PEAK TO PEAK ACCELERATION G

111

CONDITIONS OF MAXIMUM ACCELERATIONS				COMPRESSION	
FREQUENCY -HZ	FLIGHT CONDITIONS	CONFIG	ATT5G	LACATION NUMBER	VIB AMPL %g
120	VMU R/D	ALICE	H	44	2.3
212	LOG A	LIGHT	H	43	2.0
424	15° BT	LIGHT	H	43	2.2
636	15° BT	HEAVY	V	44	3.2
848	VMU R/D	SLING LOAD	H	44	3.5
1012	LOG A	LIGHT	V	44	2.0
1274	AT (O.P. W)	SINGLE LOG	V	44	2.0
1480	VMU R/D	LIGHT	V	44	2.5
1668	COND (FLT IDLE)	LIGHT	V	44	3.8
1804	VMU R/D	SINGLE LOG	H	43	2.5

200 400 600 800 1000 1200 1400 1500 1800 2000
FREQUENCY HZ

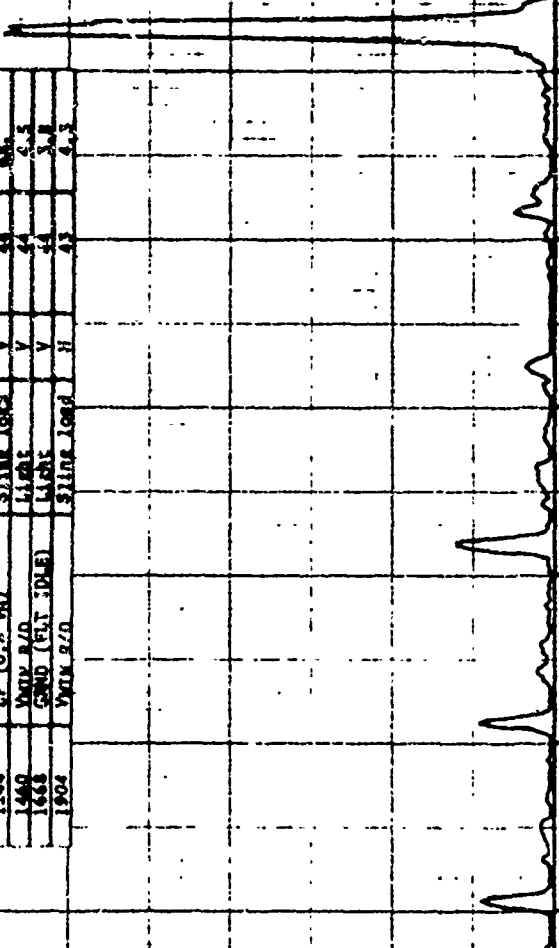
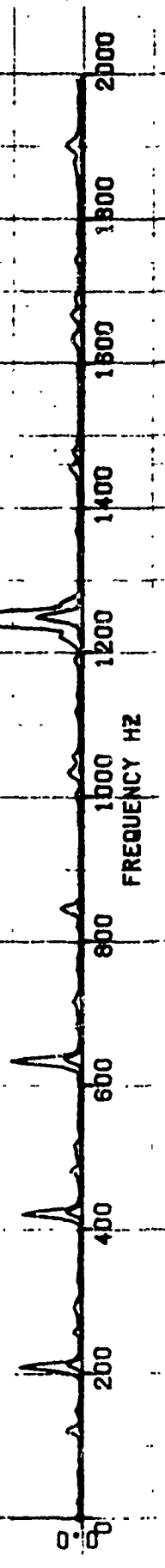

FIG 25 COMPRESSED VIBRATION DATA

CH-47C UBR B/N 68-17126
A/C CONFIG-COMB CLEAN-SLING AND INTERNAL LOAD
COMBINED FLT CONDITIONS
COMB GEARBOXES COMB AXIS-SENSOR LOC 43.44.45
COMPRESSION PASS NO.2 VIB PLOT 158

ONE HALF PEAK TO PEAK ACCELERATION G
100.0
80.0
60.0
40.0
20.0
0.0

— MEAN ACCELERATION
— MEAN PLUS 3 SIGMA UPPER ACCELERATION LIMIT



COMPRESSED VIBRATION DATA MAXIMUM ACCELERATION

FIG 26

CH-47C USA B/N 89-17126
 R/C CONFIG-COMB CLEAN, SLING AND INTERNAL LOAD
 COMBINED FLT CONDITIONS
 RT ALTERNATE COMB AX18-SENSOR LOC 48
 COMPRESSION PASS NO.2 VIB PLOT 158

CONDITIONS OF MAXIMUM ACCELERATIONS				COMPRESSION	
FREQUENCY -HZ	FLIGHT CONDITIONS	CONFIG	AXIS	LOCATION NUMBER	VIB AMPL %g
596	VEST. R/C	LIGHT	H	48	3.3
712	GRND (GRND IDLE)	LIGHT	L	48	3.8
812	GRND (GRND IDLE)	LIGHT	L	48	3.4
848	HOVER (GR)	HEAVY	V	48	3.3
1184	GRND (FLT IDLE)	LIGHT	L	48	3.3
1328	GRND (GRND IDLE)	LIGHT	L	48	3.4
1344	GRND (GRND IDLE)	LIGHT	V	48	3.4
1544	HOVER (GR)	LIGHT	H	48	3.4
1572	GRND (FLT IDLE)	LIGHT	H	48	3.7
1604	FF (W)	HEAVY	V	48	3.4

ONE HALF PEAK TO PEAK ACCELERATION G

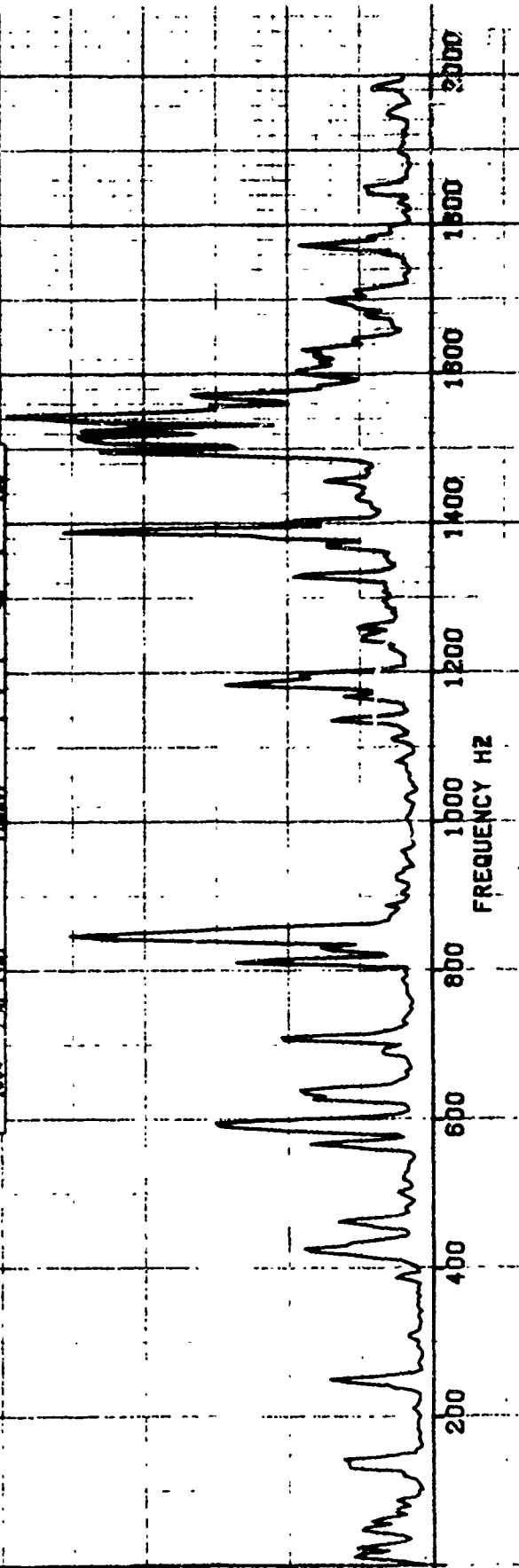

FIG 27
 COMPRESSED VIBRATION DATA
 CH-47C USA S/N 69-17126
 A/C CONF: G-COMB CLEAN, SLING AND INTERNAL LOAD
 COMBINED FLT CONDITIONS
 RT ALTERNATE COMB AXIS-SENSOR LOC 46
 COMPRESSION PASS NO.2 VIB PLOT 159

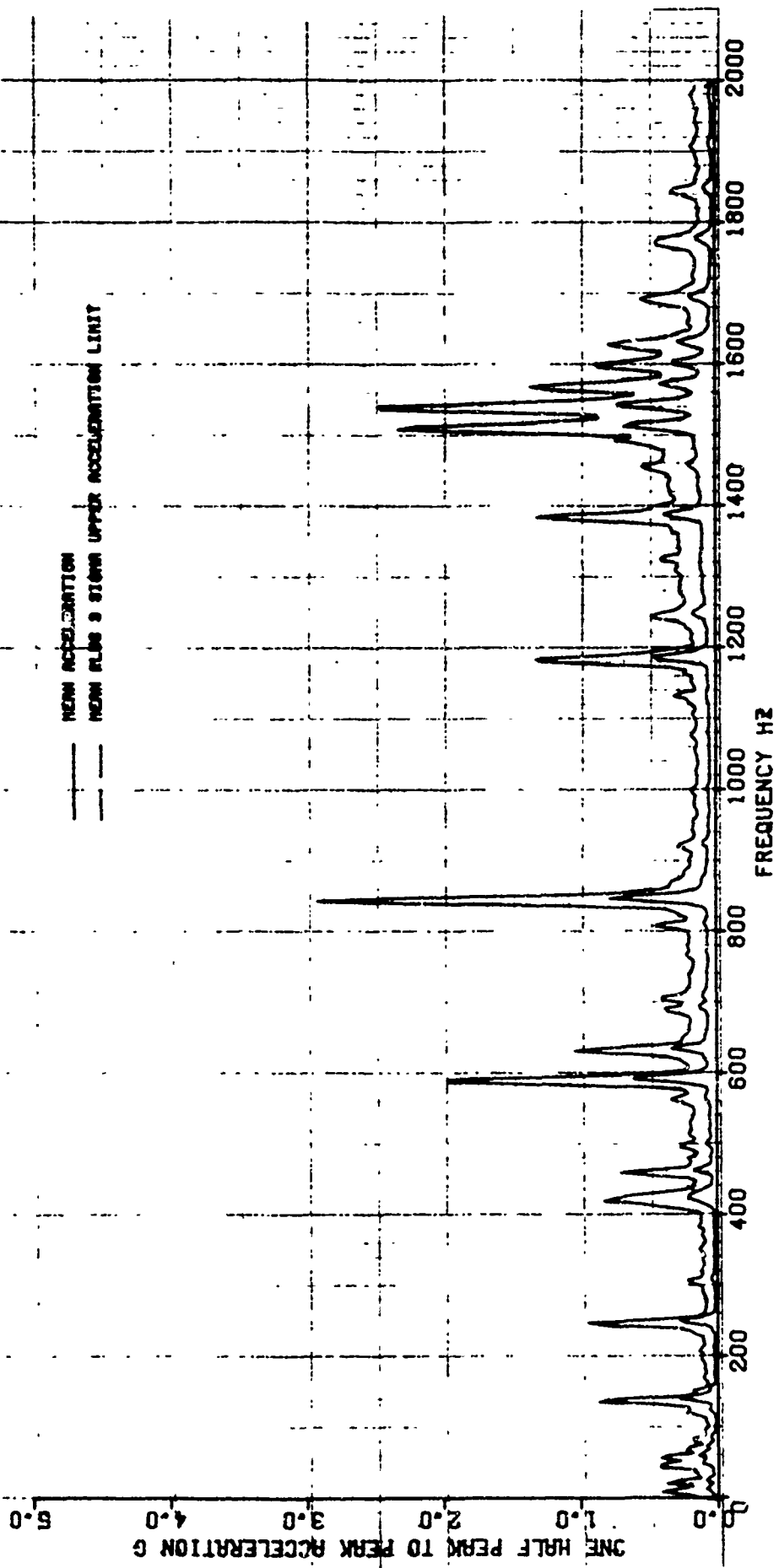

FIG 28 COMPRESSED VIBRATION DATA MAXIMUM ACCELERATION

CH-47C USA S/N 68-17126
 R/C CONFIG-COMB CLEAN, SLING AND INTERNAL LOAD
 COMBINED FLT CONDITIONS
 COMB ENG MNTS COMB AXIS-SENSOR LOC 47, 48, 49
 COMPRESSION PASS NO. 2 VIB PLOT 160

CONDITIONS OF MAXIMUM ACCELERATIONS				COMPRESSION	
FREQUENCY -HZ	FLIGHT CONDITIONS	COMPIG	AXIS	LOCATION NUMBER	VIB AMPL -g
24	LOG A	LIGHT	H	47	4.1
48	LOG A	LIGHT	H	47	4.1
80	LOG A	LIGHT	H	47	3.2
212	LOG B	LIGHT	H	47	5.0
424	LOG A	LIGHT	H	47	3.1
636	DOWN R/D	HEAVY	V	47	3.1
1274	DOWN (OGR)	HEAVY	H	47	4.1
1508	DOWN R/D	SLING LOAD	H	47	4.1
1868	DOWN R/D	HEAVY	H	47	3.1
1878	HEAVY (LGE)	HEAVY	H	47	1.1

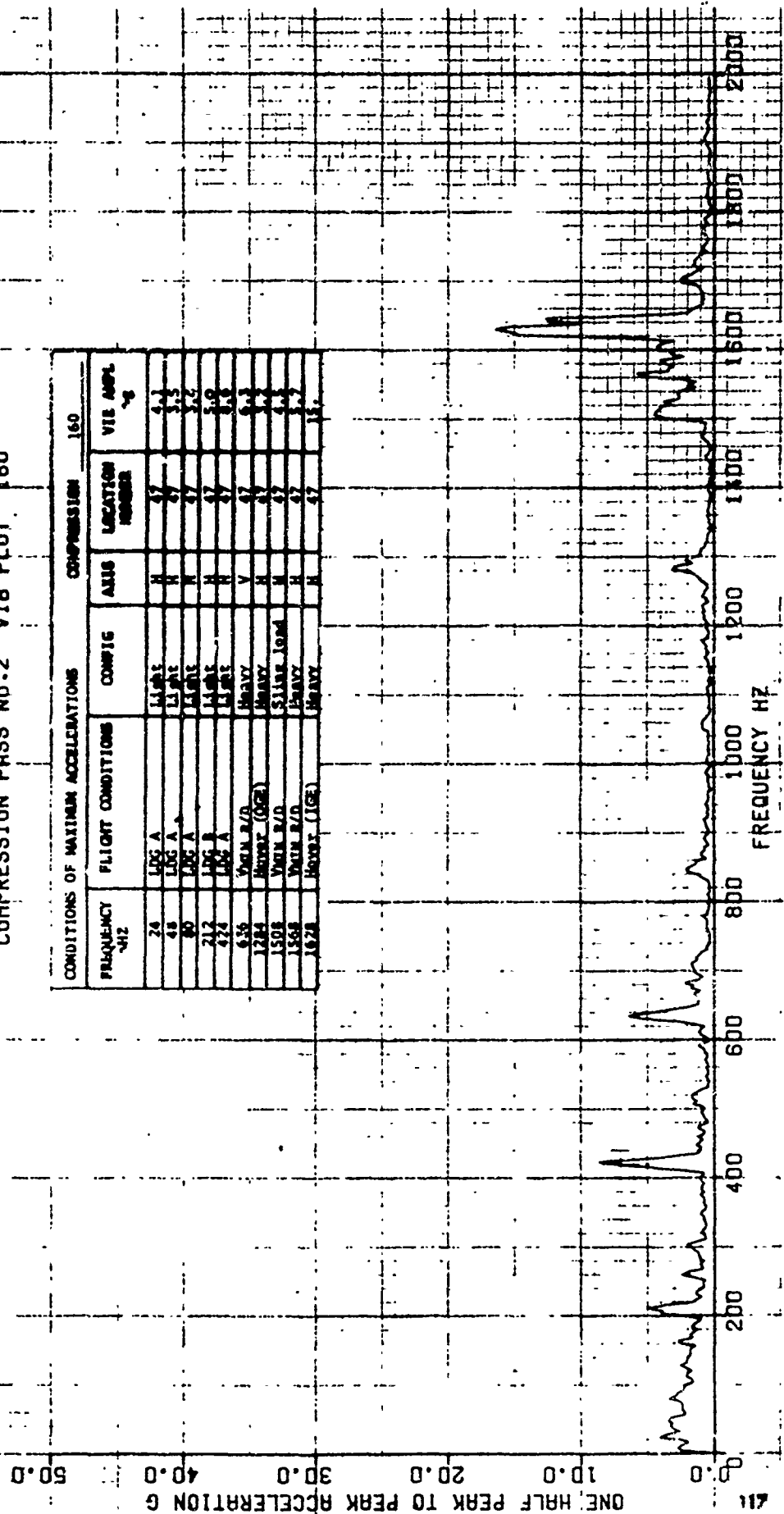

FIG 29
COMPRESSED VIBRATION DATA

CH-47C USAF 68-17126
A/C CONFIG-COMB CLEAN, SLING AND INTERNAL LOAD
COMBINED FLT CONDITIONS
COMB. ENG. MNTS COMB AXIS-SENSOR LOC. 47-48.48
COMPRESSION PASS NO. 2 VIB PLOT 160

MEAN ACCELERATION
MEAN PLR 2 SIGMA UPPER ACCELERATION LIMIT

81X

ONE HALF PEAK TO PEAK ACCELERATION G
0.0 10.0 20.0 30.0 40.0 50.0

200 400 600 800 1000 1200 1400 1600 1800 2000
FREQUENCY HZ

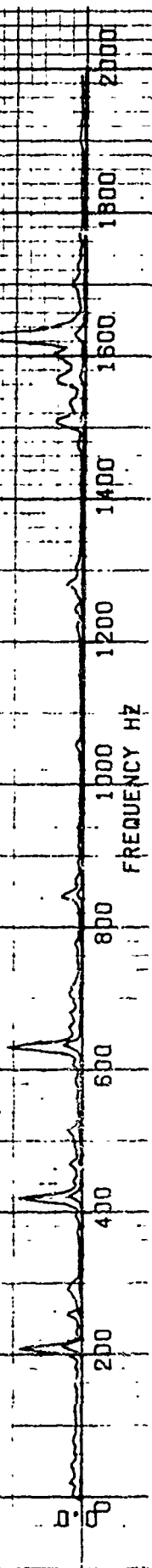

COMPRESSED VIBRATION DATA MAXIMUM ACCELERATION

FIG 30

CH-47C, USA S/N 69-17126
 A/C CONFIG-COMB CLEAN, SLING AND INTERNAL LOAD
 COMBINED FLT. CONDITIONS
 ENGINE COMB AXIS-SENSOR LOC 50.51.52
 COMPRESSION PASS NO.2 VIB PLOT 161

CONDITIONS OF MAXIMUM ACCELERATIONS					COMPRESSION 161	
FREQUENCY Hz	FLIGHT CONDITIONS	COMPTE	AXIS	LOCATION NUMBER	VIB AMPL %g	
32	15° FT	LARGE	L	51	6.3	
72	15° FT	LARGE	L	51	6.1	
212	LOG B	LARGE	H	52	11.1	
280	HOVER (IGE)	MANY	H	51	10.2	
424	LOG B	LARGE	H	51	10.1	
472	GRND (FLT IDLE)	LARGE	H	51	11.1	
636	DOWN R/D	SLANG LOAD	H	51	7.8	
900	GRND (FLT IDLE)	LARGE	L	51	8.1	
1176	GRND (GRND IDLE)	LARGE	H	51	7.3	
1908	Y500 FEW R/D	SLANG LOAD	H	50	7.8	

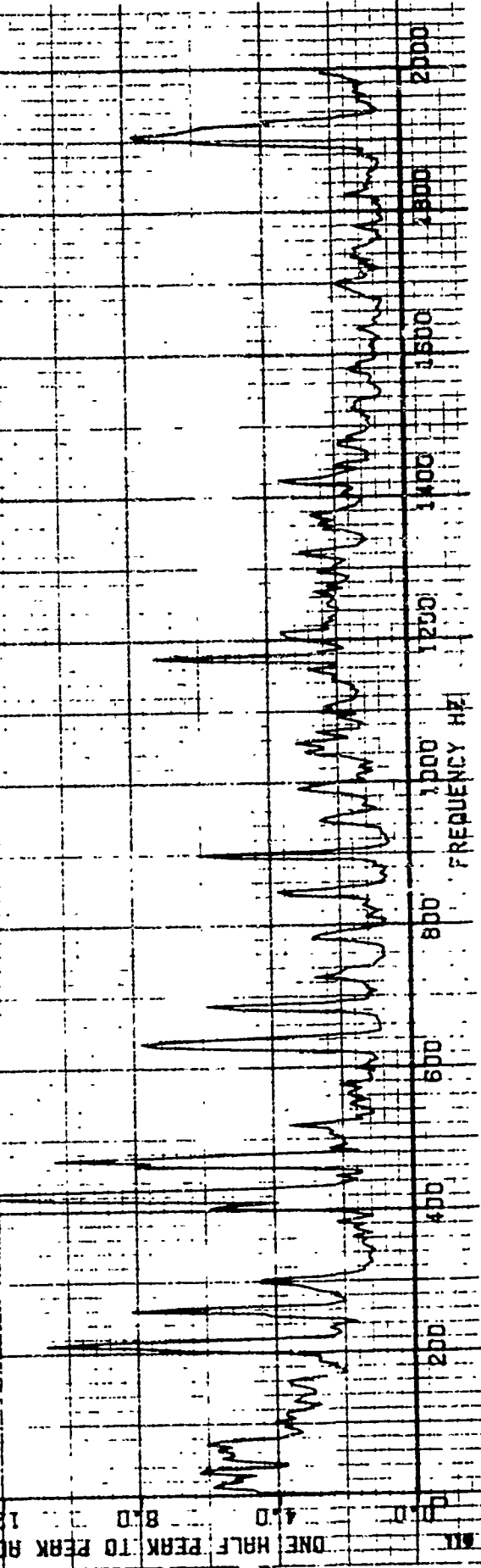

FIG 31

COMPRESSED VIBRATION DATA

CH. 171 USB 5/16/81 17126
A/C CONFIG-COMB CLEAN SLING AND INTERNAL LOAD
ENGINE COMB BK15-SENSOR LOC 50.51.52
COMPRESSION PRESS NO. 2 VIB PLOT 161

MAX ACCELERATION
LIMIT AT 3.000 UPPER ACCELERATION LIMIT

ONE HALF PEAK TO PEAK ACCELERATION G
4.0
8.0
12.0
15.0
20.0

G

FREQUENCY. HZ

2000

1800

1600

1400

1200

1000

800

600

400

200

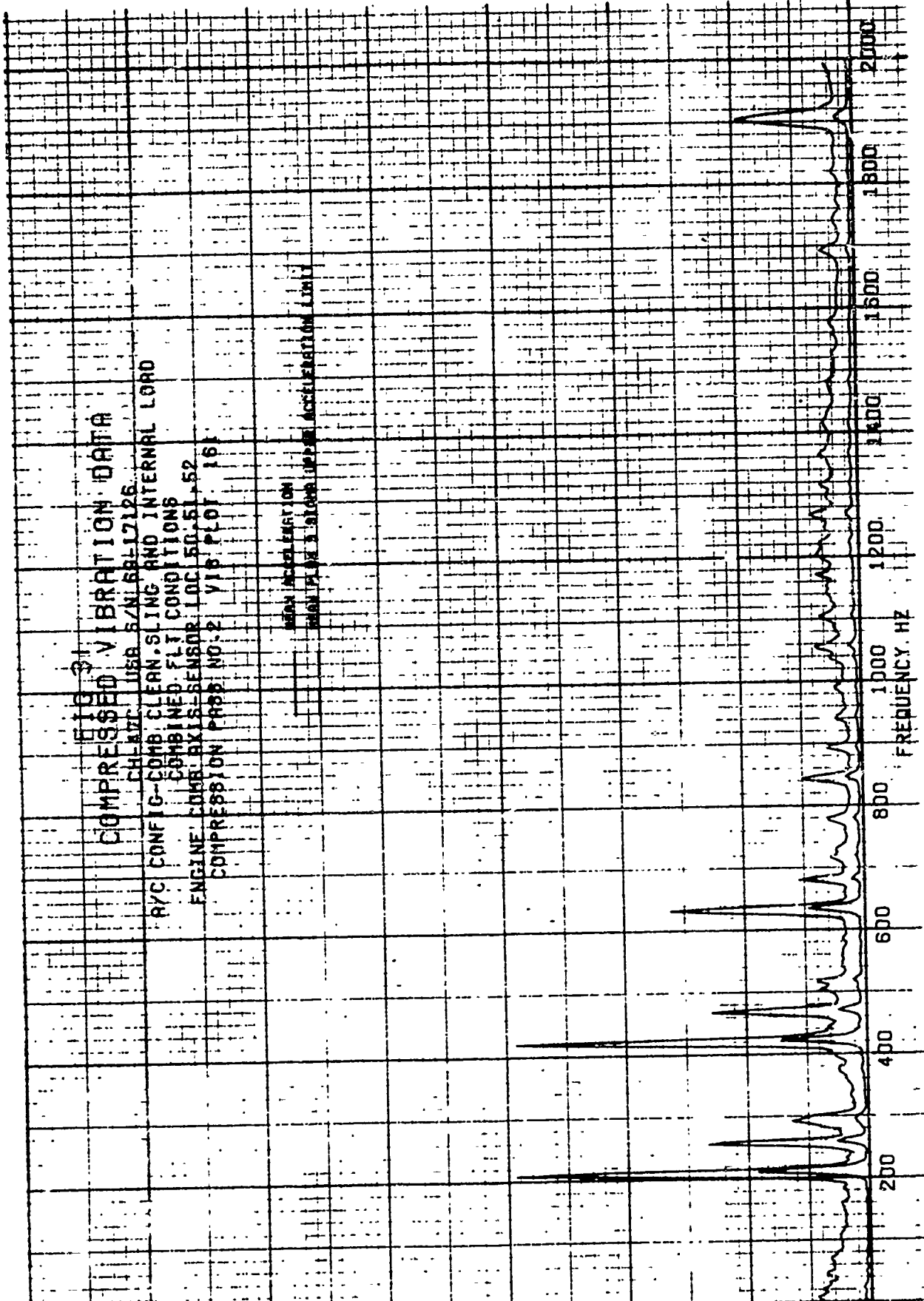

COMPRESSED VIBRATION DATA MAXIMUM ACCELERATION

FIG 32

CH-47C US8 S/N 62-17126
 A/C CONFIG-COMB CLEAN SLING AND INTERNAL LOAD
 COMBINED FLT CONDITIONS
 HYDRAULIC SYS COMB AXIS-SENSOR LOC 53-54
 COMPRESSION PASS NO.2 VIB PLOT 162

ONE HALF PEAK TO PEAK ACCELERATION G

CONDITIONS OF MATING: ACCELERATIONS			COMPRESSION		
FREQUENCY -HZ	FLIGHT CONDITIONS	ORNGWG	AXIS	LOCATION NUMBER	VIB APPX %g
506	GRND (FLT IDLE)	LI-01	N	54	2.8
648	NAVY (GR)	NAVY	N	54	3.4
1172	GRND (GRND IDLE)	LI-01	N	53	3.1
1188	7/0 R	CLISE 1-3A	N	54	2.4
1308	NAVY: B/C	NAVY	N	54	2.8
1516	15° RT	LI-01	N	54	4.0
1578	15° RT	LI-01	N	54	4.0
1632	15° RT	LI-01	N	54	4.0
1748	NAVY: B/C	NAVY	N	54	3.1
1852	NAVY: B/C	NAVY	N	54	4.0

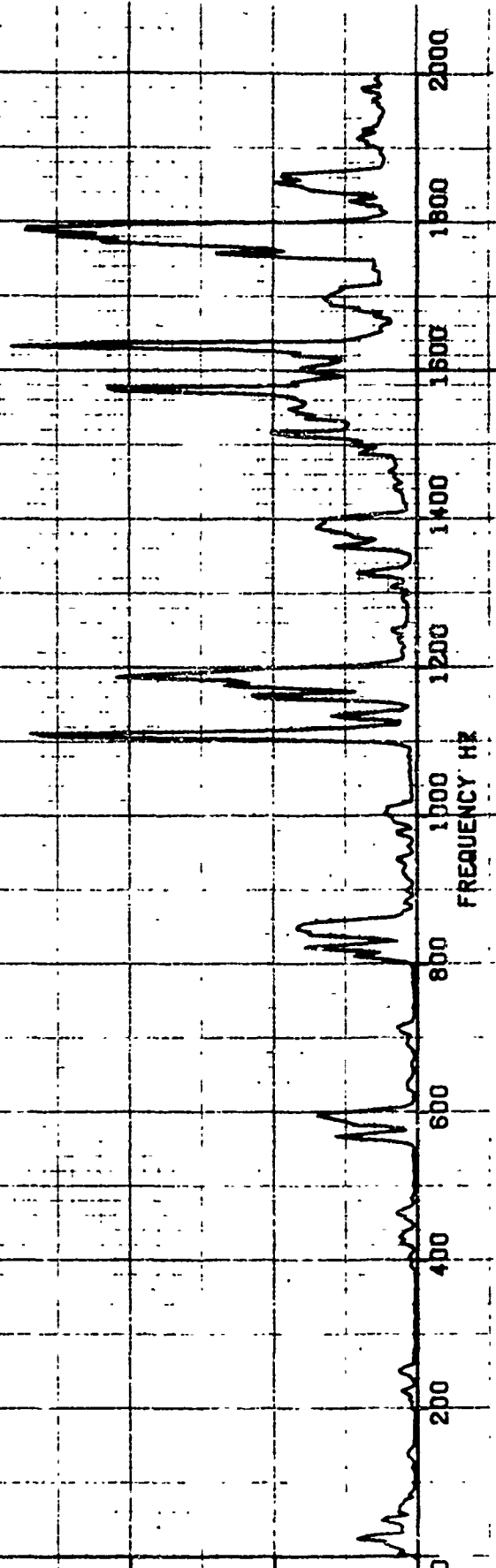

**FIG 33
COMPRESSED VIBRATION DATA**

CH-47C USA 8/N 69-17126
A/C CONFIG-COMB CLEAN-SLING AND INTERNAL LOAD
COMBINED FLT. CONDITIONS
HYDRAULIC SYS COMB. AXIS-SENSOR LDC 59-54
COMPRESSION PASS NO.2 VIB PLOT 162

MINI ACCELERATION
2000 PLIN 3 0.15cm UP-DOWN ACCELERATION LIMIT

ONE HALF PEAK TO PEAK ACCELERATION G
20.0
15.0
12.0
8.0
4.0
0

FREQUENCY HZ
200 400 600 800 1000 1200 1400 1600 1800 2000

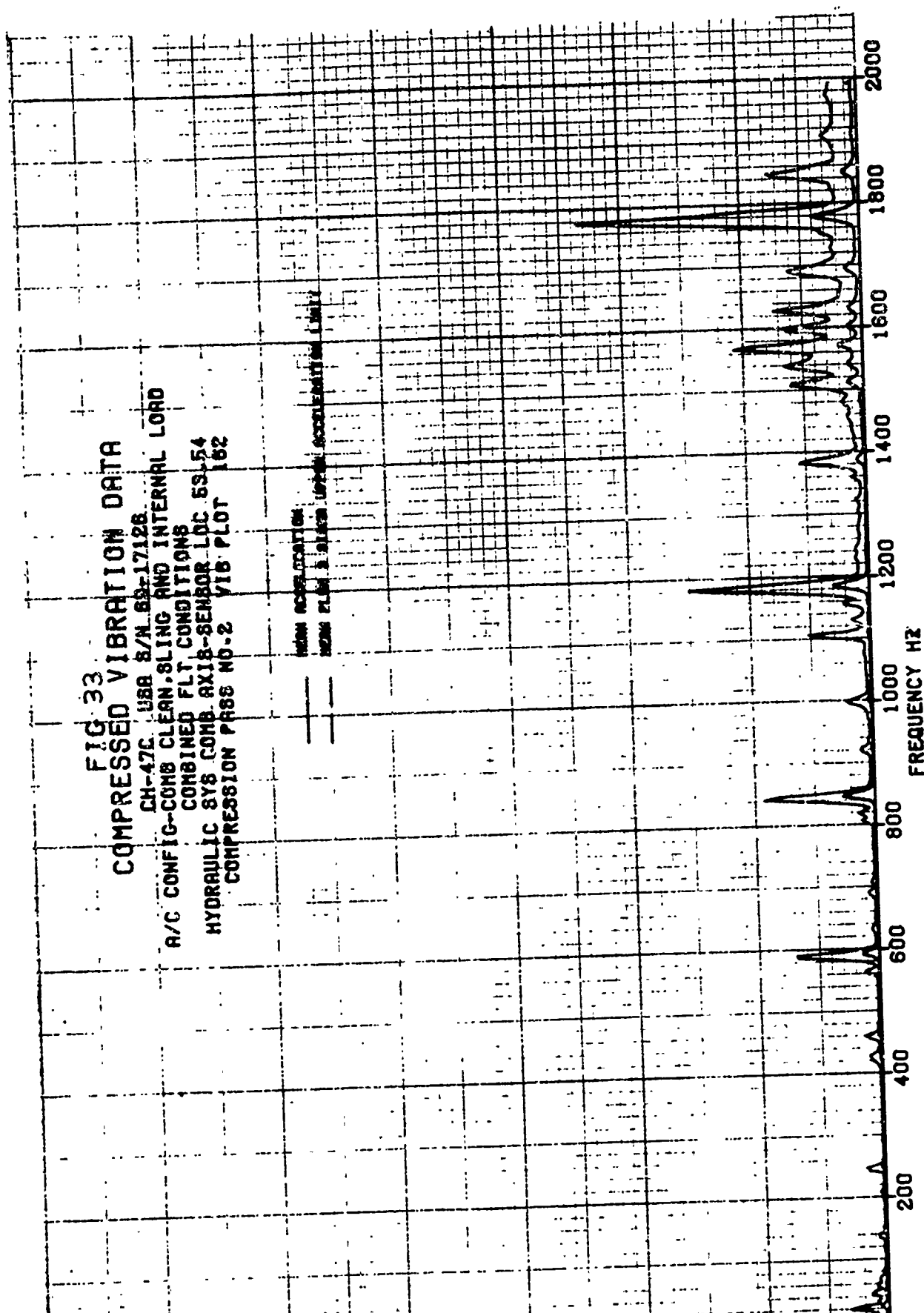

FIG 34 COMPRESSED VIBRATION DATA MAXIMUM ACCELERATION

CH-47C USAF S/N 69-17126
R/C CONFIG-COMB CLEAN, SLING AND INTERNAL LOAD
COMBINED FLT CONDITIONS
RAMP CONTROL LOBB AXIS-SENSOR LOC 55
COMPRESSION PASS NO.2 VIB PLOT 169

CONDITIONS OF MAXIMUM ACCELERATIONS				COMPRESSION 169	
FREQUENCY Hz	FLIGHT CONDITIONS	CONFIG	AXIS	LOCATED NUMBER	VIB APPX %g
20	LP (0.7 W)	Light	V	55	1.1
60	LP (0.2 W)	Light	V	55	1.0
200	DRUM R/P	Light	V	55	1.0
420	LP (0.8 W)	Light	V	55	1.0
630	15° BT	Heavy	V	55	1.0
840	LP (0.7 W)	Heavy	V	55	1.0
1300	CRND (CRND LDR)	Light	H	55	1.0
1460	CRND (FIT LDR)	Light	H	55	1.0
1570	YAGT R/C	Light	H	55	1.0
1580	15° BT	Light	H	55	1.0

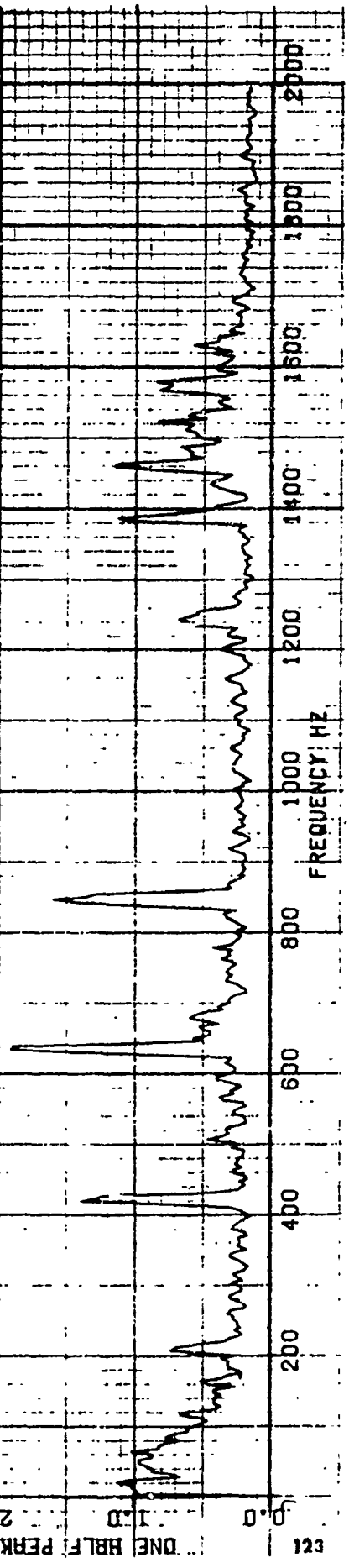

FIG 35
COMPRESSED VIBRATION DATA

R/C CONFIG-COMB USB S/N 68-17126
CH-47C CLEAN SLING AND INTERNAL LOAD
COMBINED FLY CONDITIONS
RAMP CONTROL COMB AXIS-SENSOR LOC 55
COMPRESSION PASS NO.2 VIB PLOT 169

MEAN ACCELERATION
MEAN PLUS 3 SIGMA UPPER ACCELERATION LIMIT

—
—

5.0

ONE HALF PEAK TO PEAK ACCELERATION G
2.0
3.0
4.0

0.0

FREQUENCY HZ

200 400 600 800 1000 1200 1400 1500 1800 2000

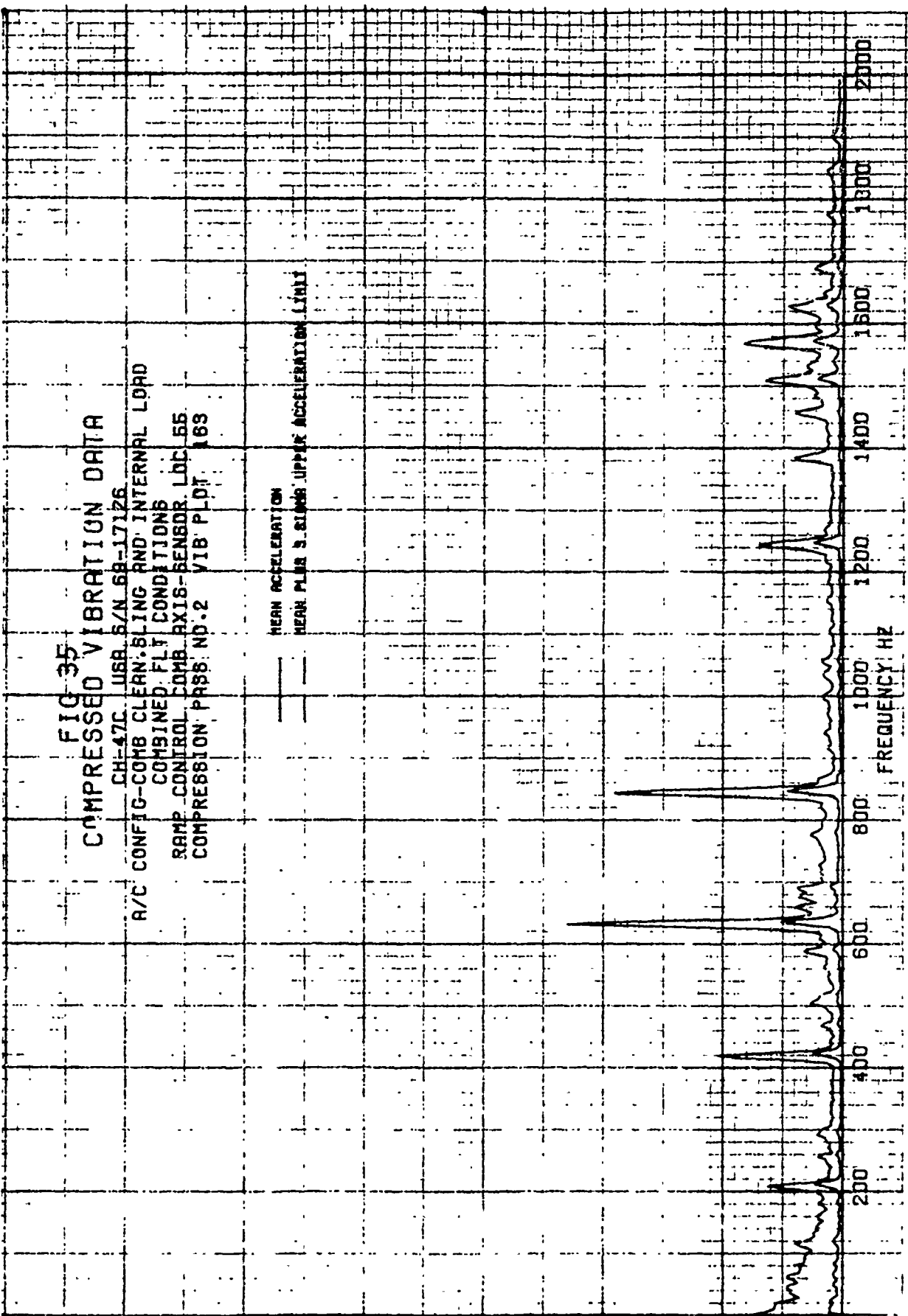

FIG 36 COMPRESSED VIBRATION DATA MAXIMUM ACCELERATION

CH-47C, USA S/N 68-17126
A/C CONFIG-COMB CLEAN, SLING AND INTERNAL LOAD
COMBINED FLT CONDITIONS
EXTERNAL LIGHTS COMB AXIS-SENSOR, LOC 56.57.58
COMPRESSION 3SS NO.2 VI6 PLOT 164

20.0

16.0

12.0

8.0

4.0

0.0

FS1

CONDITIONS OF MAXIMUM ACCELERATIONS					COMPRESSION 164	
FREQUENCY -HZ	FLIGHT CONDITIONS	CONFIG	AXIS	LOCATION NUMBER	VIB AMPL %g	
24	15° LT	Light	V	57	1.7	
48	30° RT	Light	L	56	2.3	
192	FLNG J	Light	V	58	1.7	
208	VAIN R/D	Heavy	V	58	2.2	
252	IN INT. (OGE)	Heavy	H	58	2.1	
264	V IN R/D	Light	V	58	1.5	
376	L	Light	L	58	2.3	
592	LF (O-B VAI)	Light	L	58	1.8	
1508	LF (WALTER)	Sling load	L	58	1.7	
1572	LF (WALTER)	Sling load	L	58	1.8	

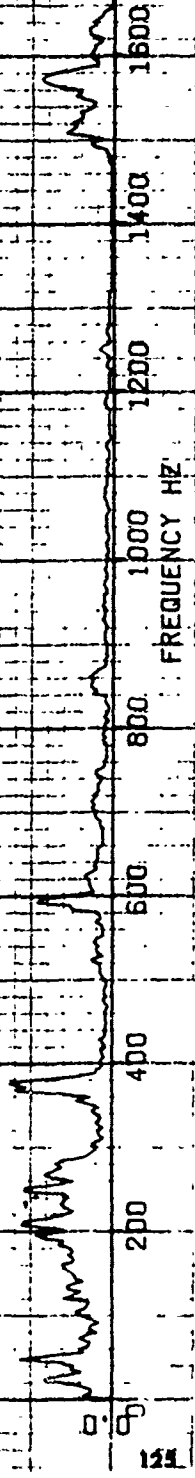

2025 RELEASE UNDER E.O. 14176

FIG 37
COMPRESSED VIBRATION DATA

CH-47C USA S/N 68-17126
R/C CONFIG-COMB CLEAN SLING AND INTERNAL LOAD
COMBINE FLT CONDITIONS
EXTERNAL LIGHTS COMB AXIS-SENSOR LOC 56157158
COMPRESSION PASS NO.2 VIB PLOT 18*

MEAN ACCELERATION
MEAN PLUS 3 STANDARD DEVIATIONS ONLY

ONE HALF PEAK TO PEAK ACCELERATION G
8.0
4.0
20.0

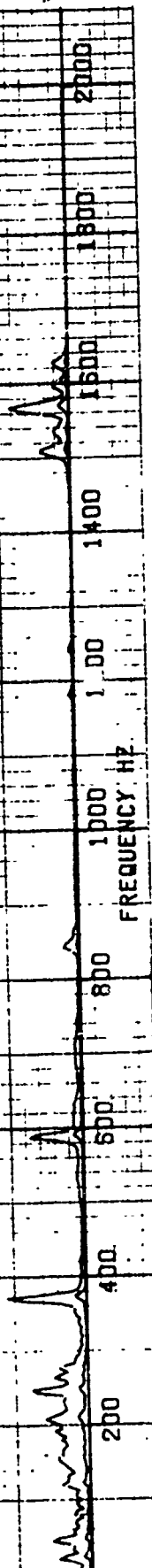

FIG 38
COMPRESSED VIBRATION DATA MAXIMUM ACCELERATION

CH-47C USB S/N 59-17126
A/C CONFIG-COMB CLEAN, SLING AND INTERNAL LOAD
COMBINED FLT CONDITIONS
CARGO FLOOR COMB. AXIS-SENSOR. DC. 59.60
COMPRESSION PASS NO. 2 VIB PLOT 165

CONDITIONS OF MAXIMUM ACCELERATIONS

FREQUENCY *HZ	FLIGHT CONDITIONS	CONFIG	AXIS	LOCATION INCHES	VIB AMPL %g
12	15° KT	Heavy	Y	60	1.0
24	Hover (OGR)	Heavy	Y	60	1.1
48	30 KT	Heavy	Y	60	1.4
96	Hover (OGR)	Heavy	Y	60	1.4
212	15° KT	Light	H	60	1.4
424	15° KT	Light	Y	60	1.2
592	V500 RPM R/D	Heavy	Y	60	1.0
636	15° KT	Light	L	60	2.4
684	15° KT	Light	L	60	2.1
848	Hover (OGR)	Sling Load	H	60	2.3

5.0

4.0

2.0

1.0

0.5

2X

ONE HALF PEAK TO PEAK ACCELERATION G

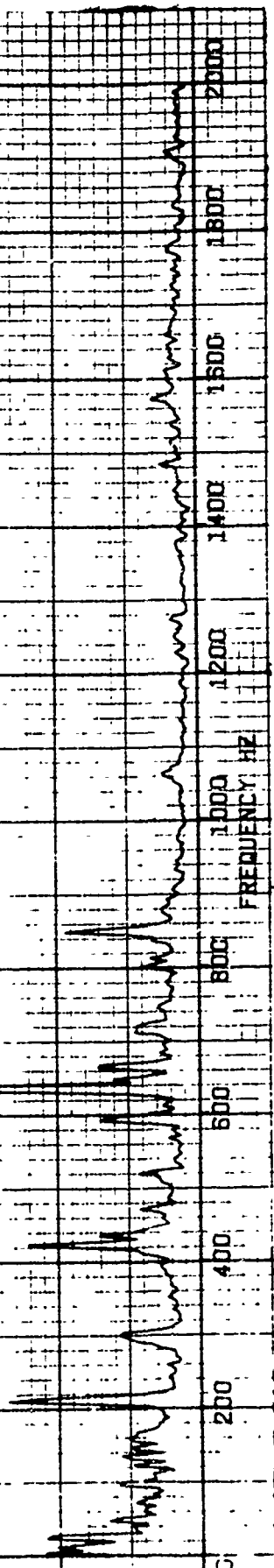

FIG 39
COMPRESSED VIBRATION DATA

CH-47C USA S/N 69-17126
A/C CONFIG-COMB CLEAN SLING AND INTERNAL LOAD
COMBINED FLT CONDITIONS
CARGO FLOOR COMB AXIS-SENSOR LOC 5B,6C
COMPRESSION PASS NO.2 VIB PLOT 155

MEAN ACCELERATION
MEAN/PLS 5.0/1000/UPPER ACCELERATION LIMIT

821

ONE HALF PEAK TO PEAK ACCELERATION G

FREQUENCY HZ

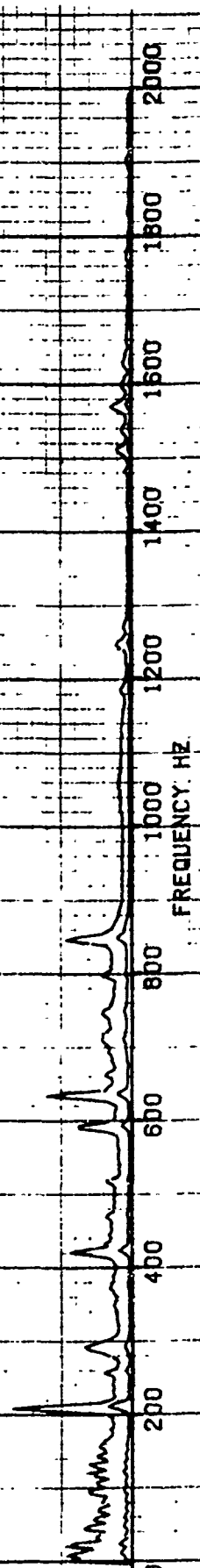

FIG 40
COMPRESSED VIBRATION DATA MAXIMUM ACCELERATION
 CH-47C USAF S/N 68-17125
 R/C CONFIG-COMB CLEAN, SLING AND INTERNAL LOAD
 COMBINED FLT CONDITIONS
 CROSS SHAFT DZEUB FABRIER COMB AXIS-SENSOR LOC B1
 COMPRESSION PASS NO.2 VIB PLOT 166

ONE HALF PEAK TO PEAK ACCELERATION G
 50.0
 40.0
 30.0
 20.0
 10.0
 0.0

CONDITIONS OF MAXIMUM ACCELERATIONS				COMPRESSION 166	
FREQUENCY -HZ	FLIGHT CONDITIONS	CONFIG	AXIS	LOCATION NUMBER	VIB AMPL g
84	LP (WR)	Sling Load	L	61	2.1
217	VIN BAG	LARGE	N	61	1.8
308	Y/O B	Sling Load	N	61	2.4
424	Mount (CG)	LARGE	N	61	2.1
504	T/O B	LARGE	V	61	2.1
520	GRD (FLT JMB)	LARGE	V	61	4.8
544	IS LT	LARGE	V	61	2.8
636	T/O A	LARGE	L	61	2.7
720	LP (WR)	Mount	V	61	1.1
848	VIN BAG	Mount	L	61	2.7

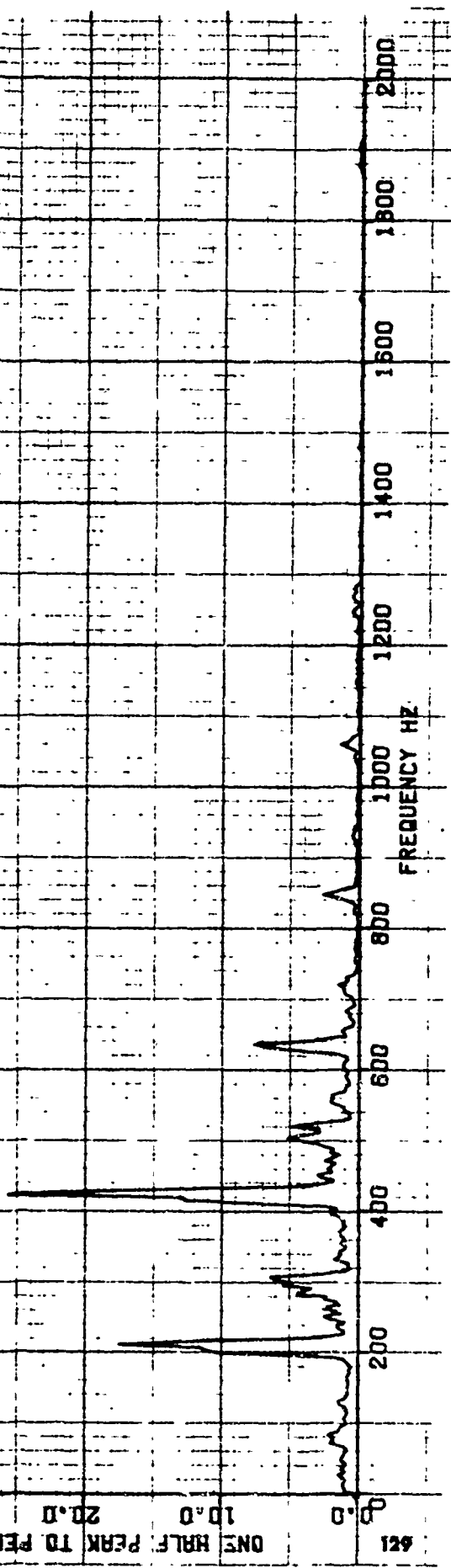

FIG 41 COMPRESSED VIBRATION DATA

CH-47C USA S/N 68-17126
A/C CONFIG-COMB CLEAN-SLING AND INTERNAL LOAD
COMBINED FLT CONDITIONS
CROSS SHAFT DIESEL FASTNER COMB AXIS-SENSOR LOC 61
COMPRESSION PASS NO.2 VIB PLOT 166

ONE HALF PEAK TO PEAK ACCELERATION G
50.0
40.0
30.0
20.0
10.0
0.0

MEAN ACCELERATION
MEAN PLUM & SLING UPPER ACCELERATION LIMIT

—
—

2000
1800
1600
1400
1200
1000
800
600
400
200
0
FREQUENCY HZ

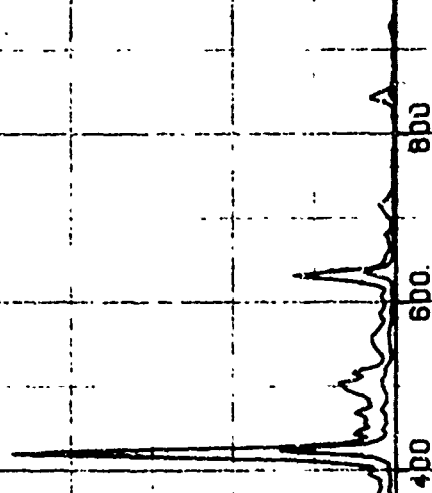

FIG 42
 COMPRESSED VIBRATION DATA MAXIMUM ACCELERATION

CH-47C USA S/N 69-17126
 A/C CONFIG-COMB CLEAN, SLING AND INTERNAL LOAD
 COMBINED FLT CONDITIONS
 BAT COMPT LATCH COMB AXIS-SENSOR LOC. 62
 COMPRESSION PASS NO.2 VIB PLOT '67

CONDITIONS OF MAXIMUM ACCELERATIONS				COMPRESSION 167	
FREQUENCY Hz	FLIGHT CONDITIONS	CONFIG	AXIS	LOCATION NUMBER	VIB AMPL %g
3	15° RT	LLHRT	H	62	1.50
74	15° RT	HEAVY	V	62	1.10
86	15° RT	HEAVY	V	62	1.10
110	15° RT	HEAVY	V	62	1.00
122	15° RT	HEAVY	V	62	1.00
135	15° RT	HEAVY	V	62	1.10
147	30° LT	HEAVY	V	62	1.10
158	VS00 P/D	HEAVY	V	62	1.10
428	30° LT	HEAVY	V	62	1.10
452	30° LT	HEAVY	V	62	1.32

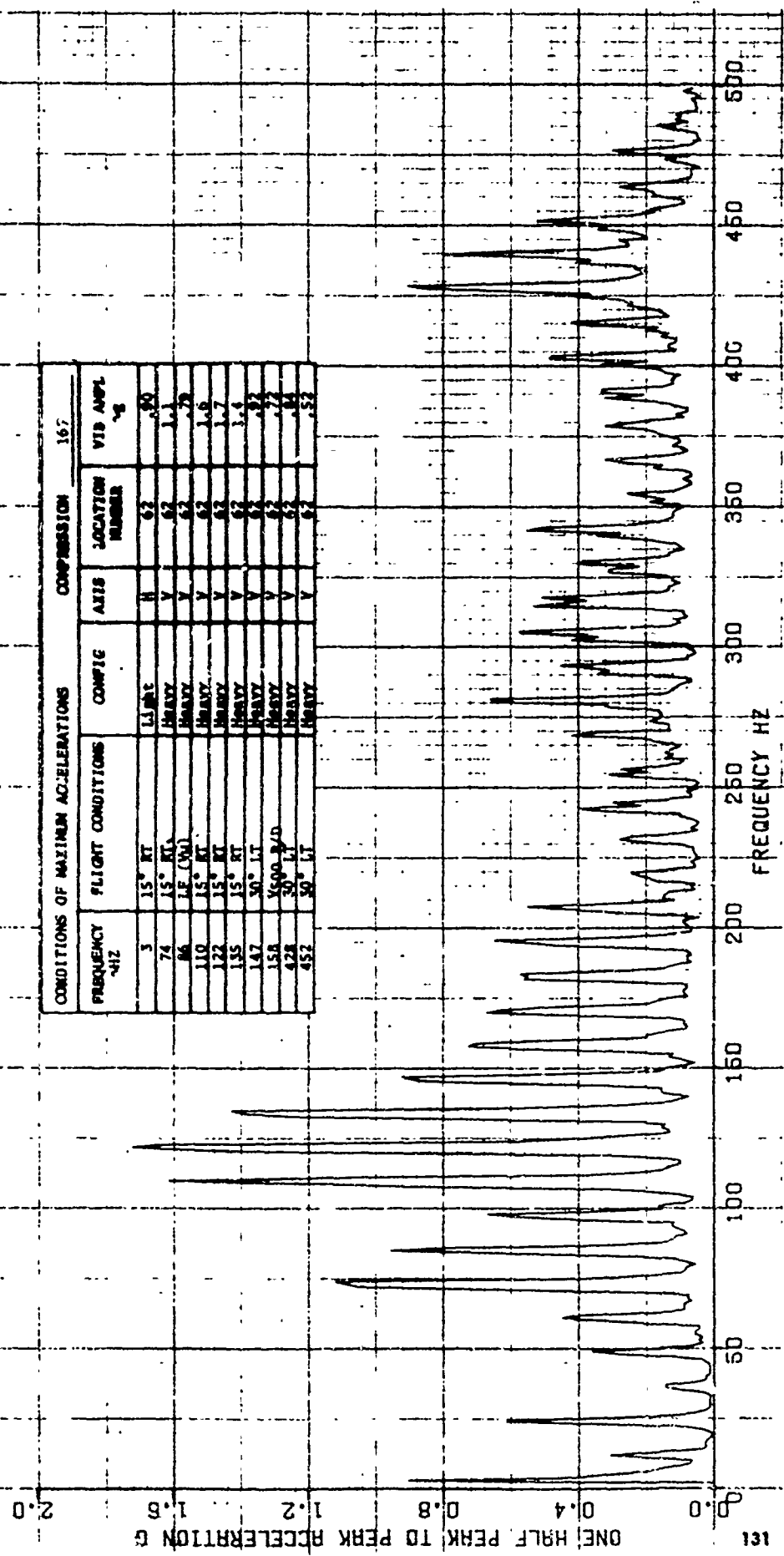

FIG 43 COMPRESSED VIBRATION DATA

CH-47C USA 67N 68-17126
A/C CONFIG-COMB CLEAN, SLING AND INTERNAL LOAD
COMBINED FLT CONDITIONS
BRI. COMPT LAICH COMB. AXIS-SENSOR LOC 62
COMPRESSION PASS NO. 2 VIB PLOT 167

MEAN ACCELERATION
MEAN PLUS 3 SIGMA UPPER ACCELERATION LIMIT

ONE HALF PEAK TO PEAK ACCELERATION G

FREQUENCY HZ

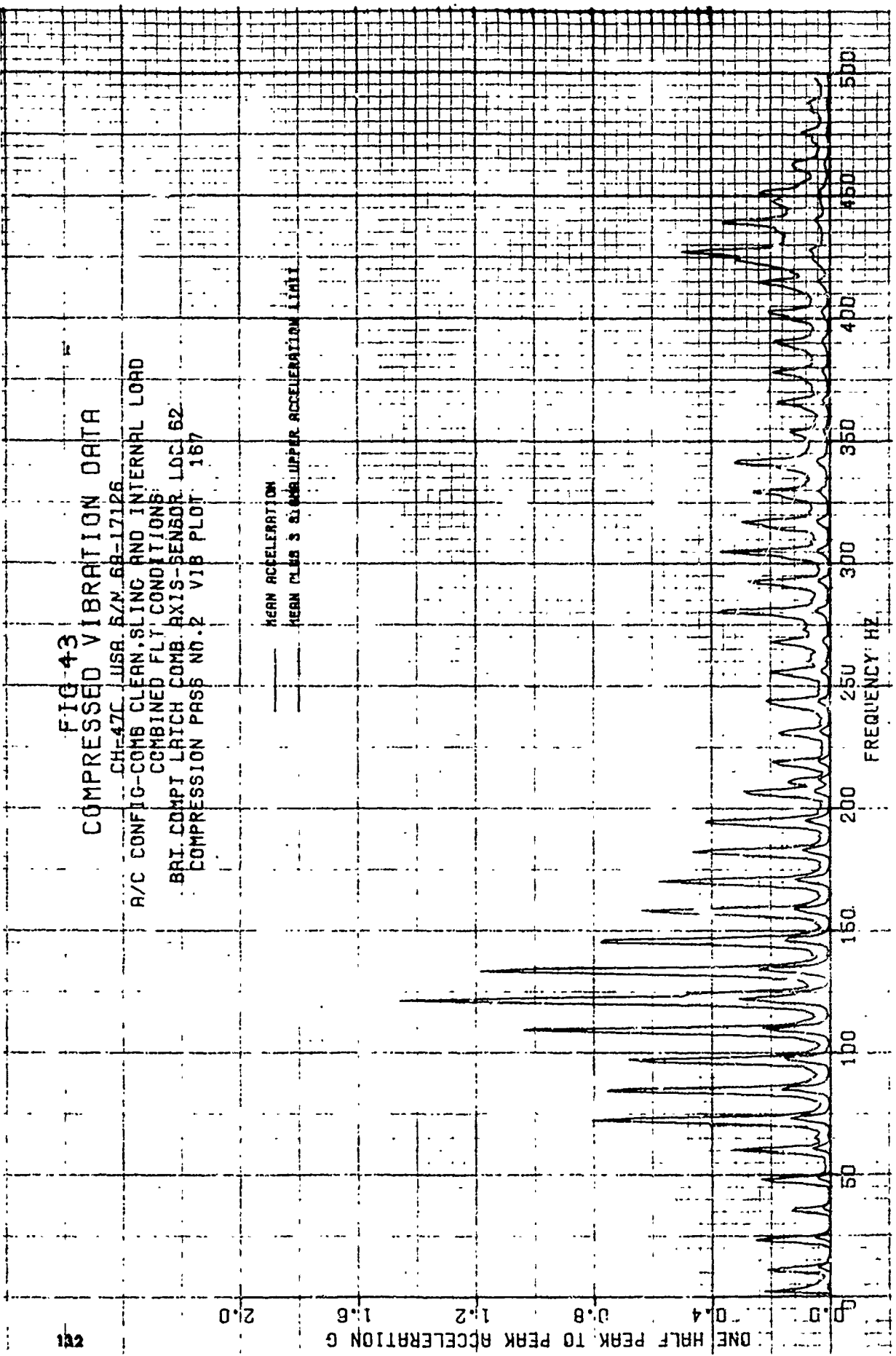
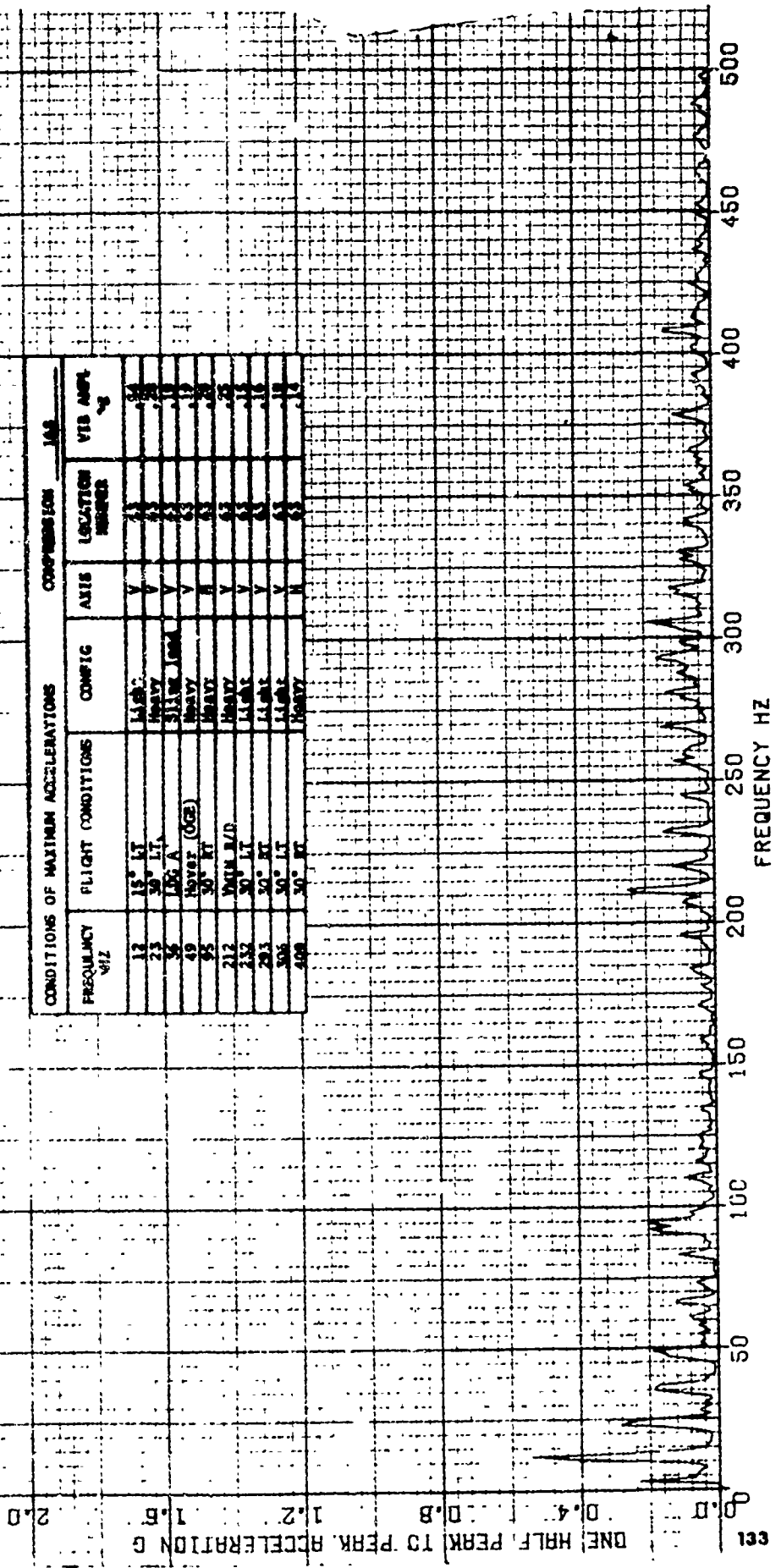

FIG 4-4
COMPRESSED VIBRATION DATA MAXIMUM ACCELERATION

A/C: CONFIG-COMB CLEAN, SLING AND INTERNAL LOAD
 CH-47C USB S/N 68-17126
 COMBINED FLT CONDITIONS
 FUEL DRAIN, COMB AXIS-SENSOR LOC 5B
 COMPRESSION PASS NO. 2 VIB PLOT 100



CONDITIONS OF MAXIMUM ACCELERATIONS				COMPRESSION	
FREQUENCY #/Z	FLIGHT CONDITIONS	CONFIG	AXIS	LOCATION NUMBER	VIB AMPT g
12	15° LT	Light	V	43	.34
13	30° LT	Heavy	V	43	.30
23	30° LT	Heavy	V	43	.19
36	100% A	Sling Load	V	43	.19
49	Hover (OGE)	Heavy	V	43	.19
55	30° RT	Heavy	H	43	.20
212	YAKN L/D	Heavy	V	43	.20
232	30° LT	Light	V	43	.16
293	30° RT	Light	V	43	.16
306	30° LT	Light	V	43	.16
408	30° RT	Heavy	H	43	.16

FIG 4-5
COMPRESSED VIBRATION DATA

CH-47C USA 5/N 68-17126
R/C CONFIG-COMB CLEAN, SLING AND INTERNAL LOAD
COMBINED FLT CONDITIONS
FUEL DRAIN COMB. AXIS-SENSOR LOC. 6B
COMPRESSION PASS NO. 2 VIB PLOT 168

MEAN ACCELERATION
MEAN OF 1/3 STOPS UPPER ACCELERATION LIMIT

ONE HALF PEAK TO PEAK ACCELERATION G
2.0
1.6
1.2
0.8
0.4
0

500
450
400
350
300
250
200
150
100
50
0
FREQUENCY HZ

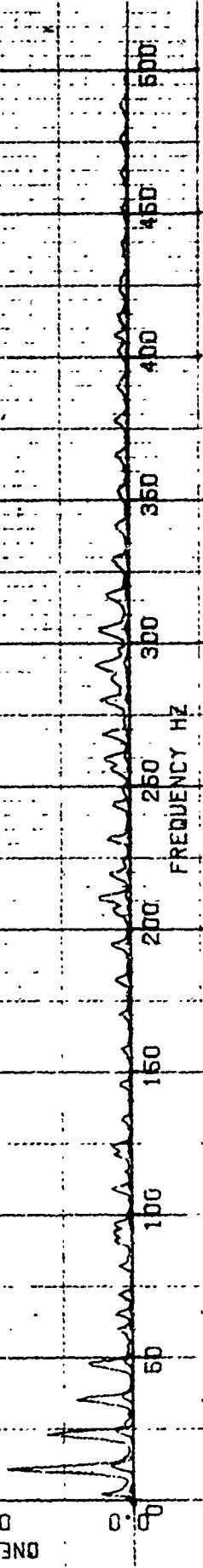

FIG 46
COMPRESSED VIBRATION DATA MAXIMUM ACCELERATION

CH-47C US8 5/N 68-17126
A/C CONFIG-COMB CLEAN, SLING AND INTERNAL LOAD
FLY COND-HOVER
INSTR PANEL COMB AXIS-SENSOR OC 1.2.3.4.5.6.7
COMPRESSION PASS NO.1 VIB PLOT 001

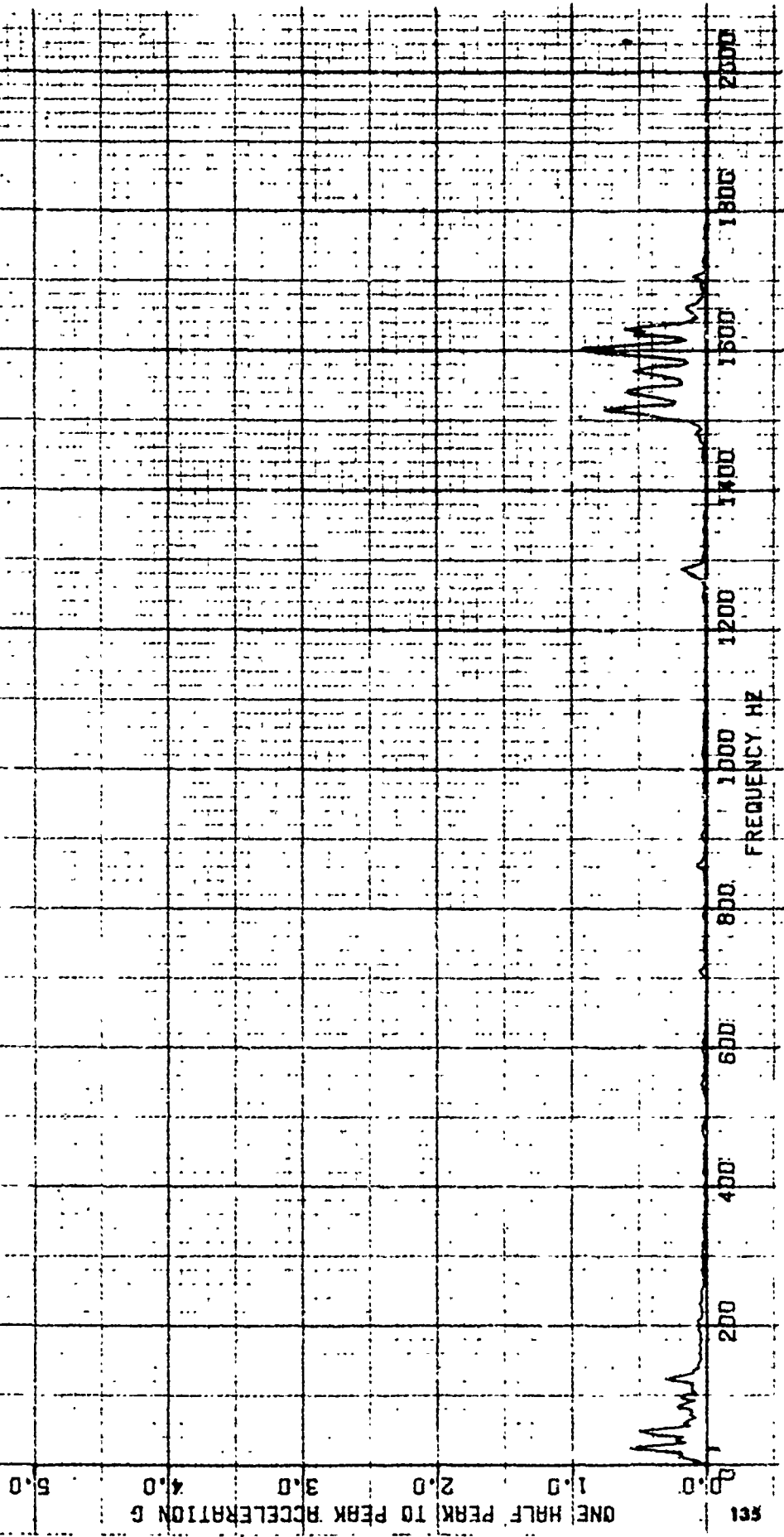

FIG 47

COMPRESSED VIBRATION DATA

CR-47C USB S/N 68-17126
R/C CONFIG-COMB CLEAN SLING AND INTERNAL LPD
FLY COND-HOVER
INSIR PANEL COMB AXIS-SENSOR LOC 1-2-3-4-5-6-7
COMPRESSION PASS NO.1 VIB PLOT 001

DOWN ACCELERATION
DOWN PLUG 8.51668 UPPER ACCELERATION LIMIT

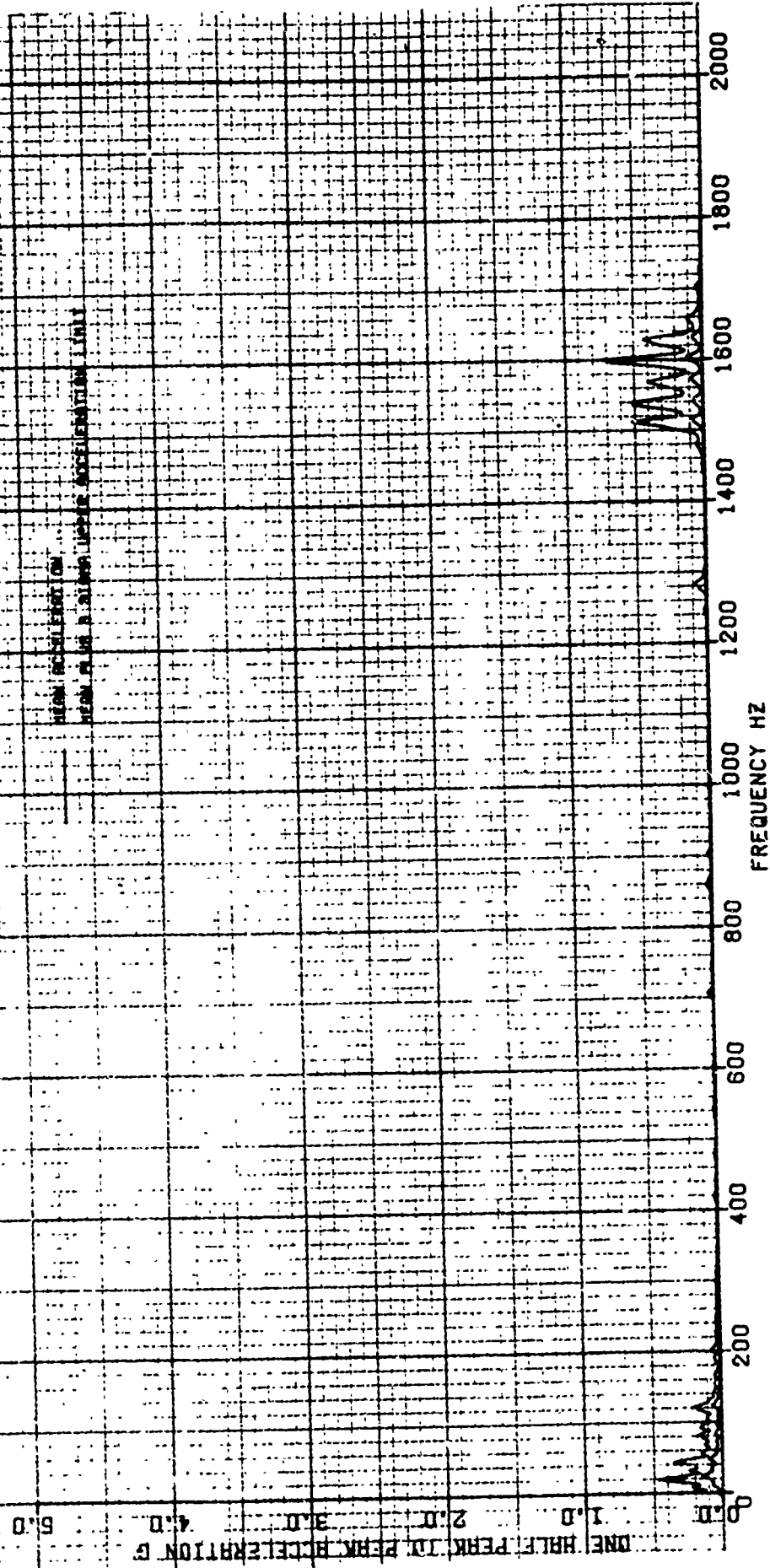

FIG 48
COMPRESSED VIBRATION DATA MAXIMUM ACCELERATION

CH-47C USA S/N 68-17126
A/C CONFIG-COMB CLEAN, SLING AND INTERNAL LOAD
FLT COND-LEVEL FLT
INSTR PANEL COMB AXIS-SENSOR LOC 1-2, 3-4-5-6, 7
COMPRESSION PASS NO. 1 VIB PLOT 002

5.0
4.0
3.0
2.0
1.0
0.0
ONE HALF PEAK TO PEAK ACCELERATION G

200 400 600 800 1000 1200 1400 1500 1800 2000
FREQUENCY HZ

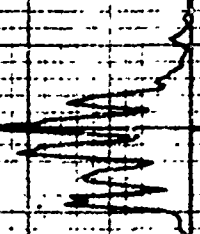

FIG 49

COMPRESSION DATA

CH-47L 1/2N 68-17126
A/C CONFIG-COMB CL... SLING AND INTERNAL LOAD
FLT COND-LEVEL FLT
INSIR PANEL COMB AXIS-SENSOR LOC 1-2-3-4-5-6-7
COMPRESSION PASS NO.1 VIB PLOT DP2

MEMO ACCELERATION
MEMO P. 08 3 SLOW UPPER ACCELERATION CHIT

0.1

5.0

4.0

3.0

2.0

1.0

0.5

0.2

0.1

0.05

0.02

0.01

0.005

0.002

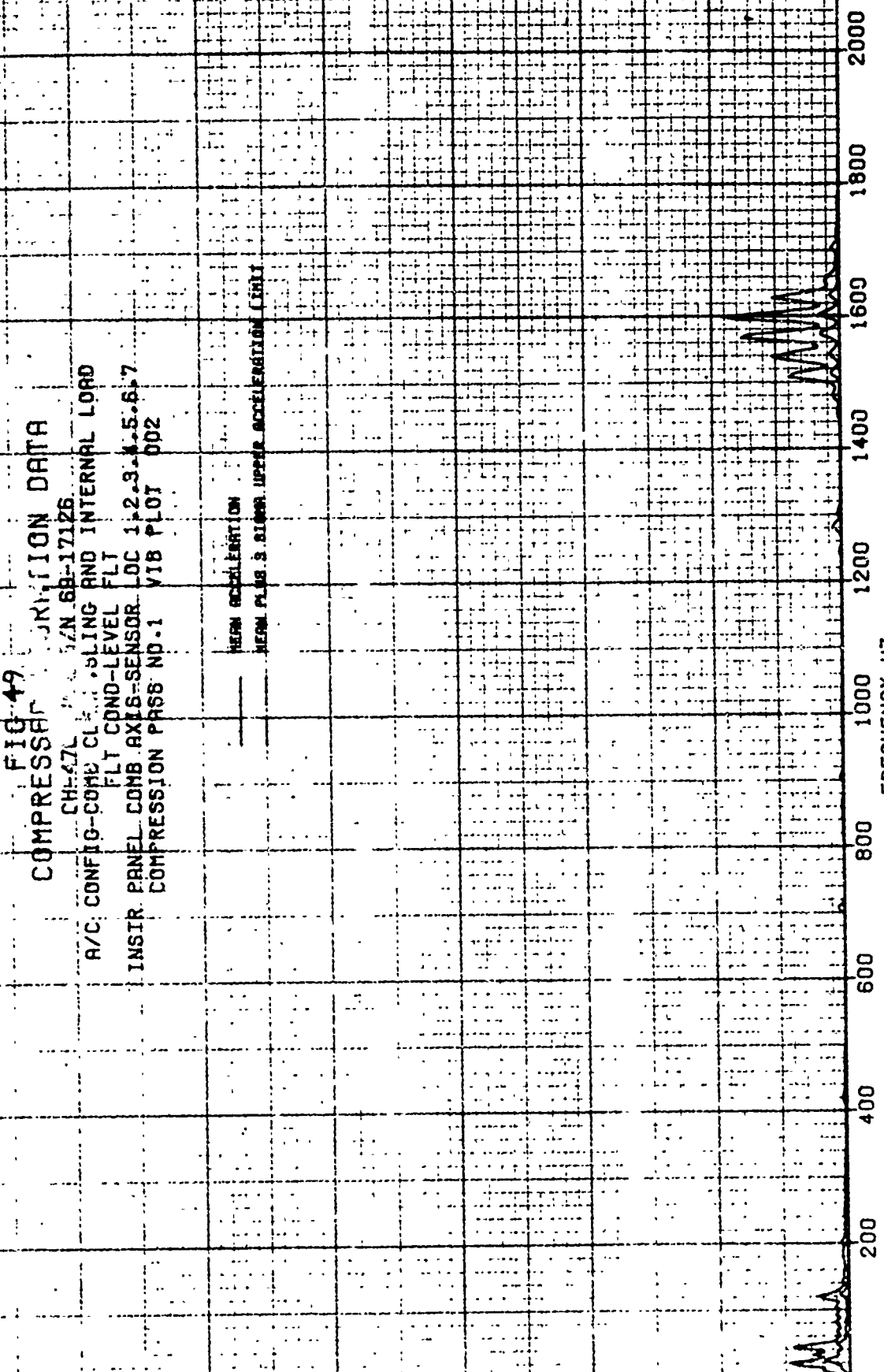

FIG 50
COMPRESSED VIBRATION DATA MAXIMUM ACCELERATION

CH-47C USAF S/N 68-17126
A/C CONFIG-COMB CLEAN, SLING AND INTERNAL LOAD
FLT CONDO-CLIMB
INSTR. PANEL COMB AXIS-SENSOR LOC 1.2.3.4.5.6.7
COMPRESSION PASS NO.1 VIB PLOT 003

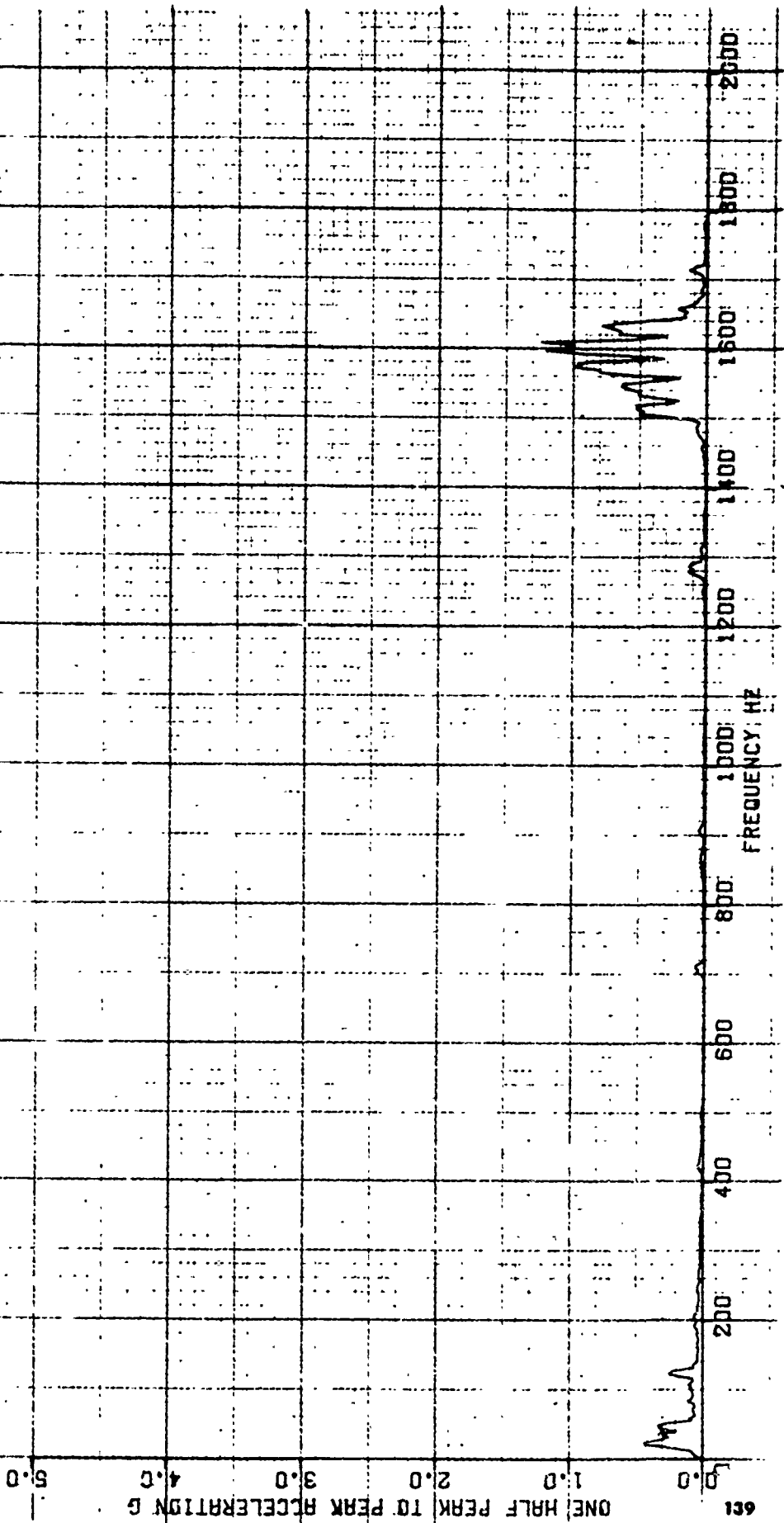

FIG 51 COMPRESSED VIBRATION DATA

CH-47C USA S/N 68-17126
 A/C CONFIG-COMB CLEAN SLING AND INTERNAL LOAD
 FLT COND-CLIMB
 INSTR PANEL COMB AXIS-SENSOR LOC 1-2-3-4-5-6-7
 COMPRESSION PASS NO.1 VIB PLOT 008

ONE HALF PEAK TO PEAK ACCELERATION G
 1.0
 2.0
 3.0
 4.0
 5.0

— PEAK ACCELERATION
 — MEAN PLUS 3 SIGMA UPPER ACCELERATION LIMIT

FREQUENCY HZ
 200 400 600 800 1000 1200 1400 1600 1800 2000

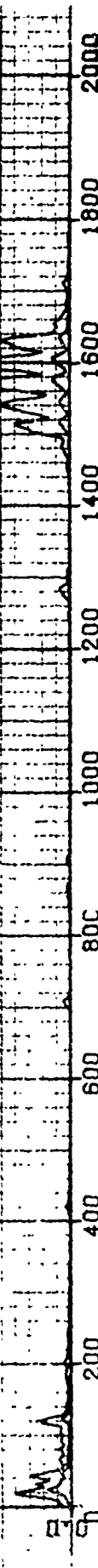

FIG 52
COMPRESSED VIBRATION DATA MAXIMUM ACCELERATION

CH-47C USA S/N 69-17126
A/C CONFIG-COMB CLEAN, SLING AND INTERNAL LOAD
FLY COND-DESCENT
INSTR PANEL CORR AXIS-SENSOR LOC 1-2-8-1-5-6-7
COMPRESSION PASS NO.1 VIB PLOT 1004

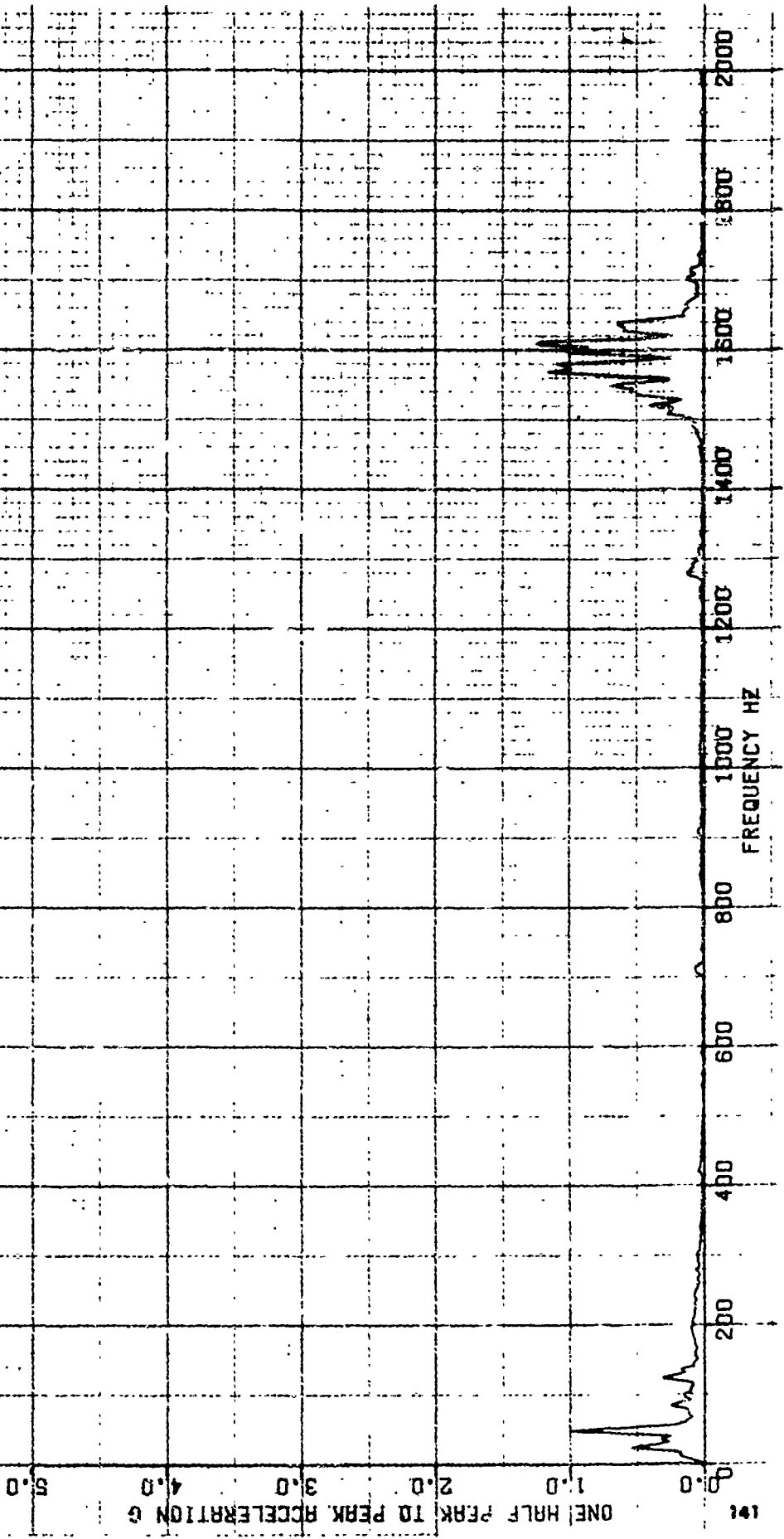

FIG 53
COMPRESSED VIBRATION DATA

CH-47C USA S/N 68-17126
A/C CONFIG-COMB CLEAN, SLING AND INTERNAL LOAD
FLT COND-DESCENT
INSTR PANEL COMB AXIS-SENSOR LOC 1.2.3.4.5.6.7
COMPRESSION PASS NO.1 VIB PLOT DD4

MEAN ACCELERATION
MEAN PLUS 3 SIGMA UPPER ACCELERATION LIMIT

ONE HALF PEAK TO PEAK ACCELERATION G
0.0
1.0
2.0
3.0
4.0
5.0

FREQUENCY HZ
200
400
600
800
1000
1200
1400
1600
1800
2000

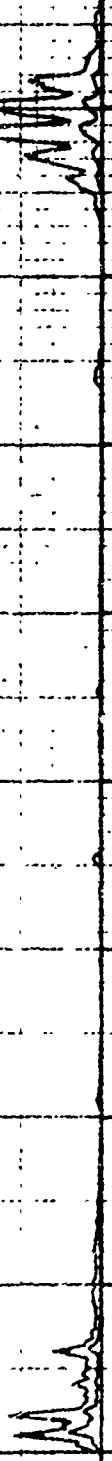

FIG 54
COMPRESSED VIBRATION DATA MAXIMUM ACCELERATION

CH-47C LUSA S/N SB-17126
A/C CONFIG-COMB CLEAN, SLING AND INTERNAL LOAD
FLT COND-COMB T/O AND LOGS
INSTR PANEL COMB AXIS-SENSOR LOC 1-2-3-4-5-6-7
COMPRESSION PASS NO.1 VIB PLOT 006

ONE HALF PEAK TO PEAK ACCELERATION G
5.0
4.0
3.0
2.0
1.0
0.0

2000
1800
1600
1400
1200
1000
800
600
400
200
0

FREQUENCY HZ

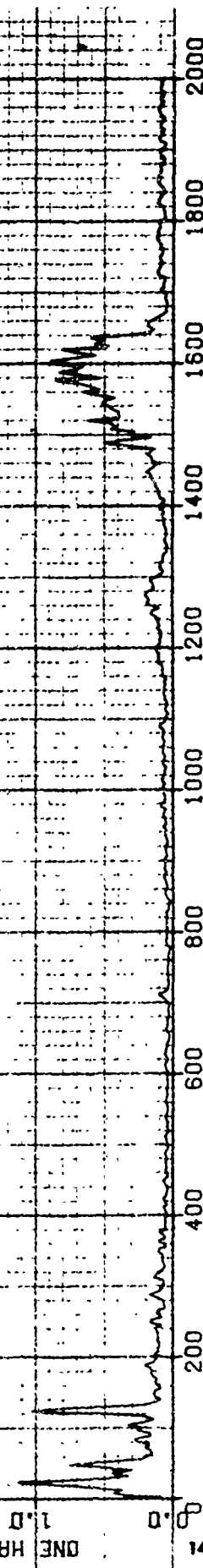

FIG 55

COMPRESSED VIBRATION DATA

CH-47C USA S/N 68-17126
R/C CONFIG-COMB CLEAN, SLING AND INTERNAL LOAD
FLT COND-COMB T/D AND LOGS
INSTR PANEL COMB AXIS-SENSOR OC 1-2-3-1-5-6-7
COMPRESSION PASS NO-1 VIB PLOT 005

MEAN ACCELERATION
MEAN PLUS 3 SIGMA UPPER ACCELERATION LIMIT

ONE HALF PEAK TO PEAK ACCELERATION G

FREQUENCY HZ

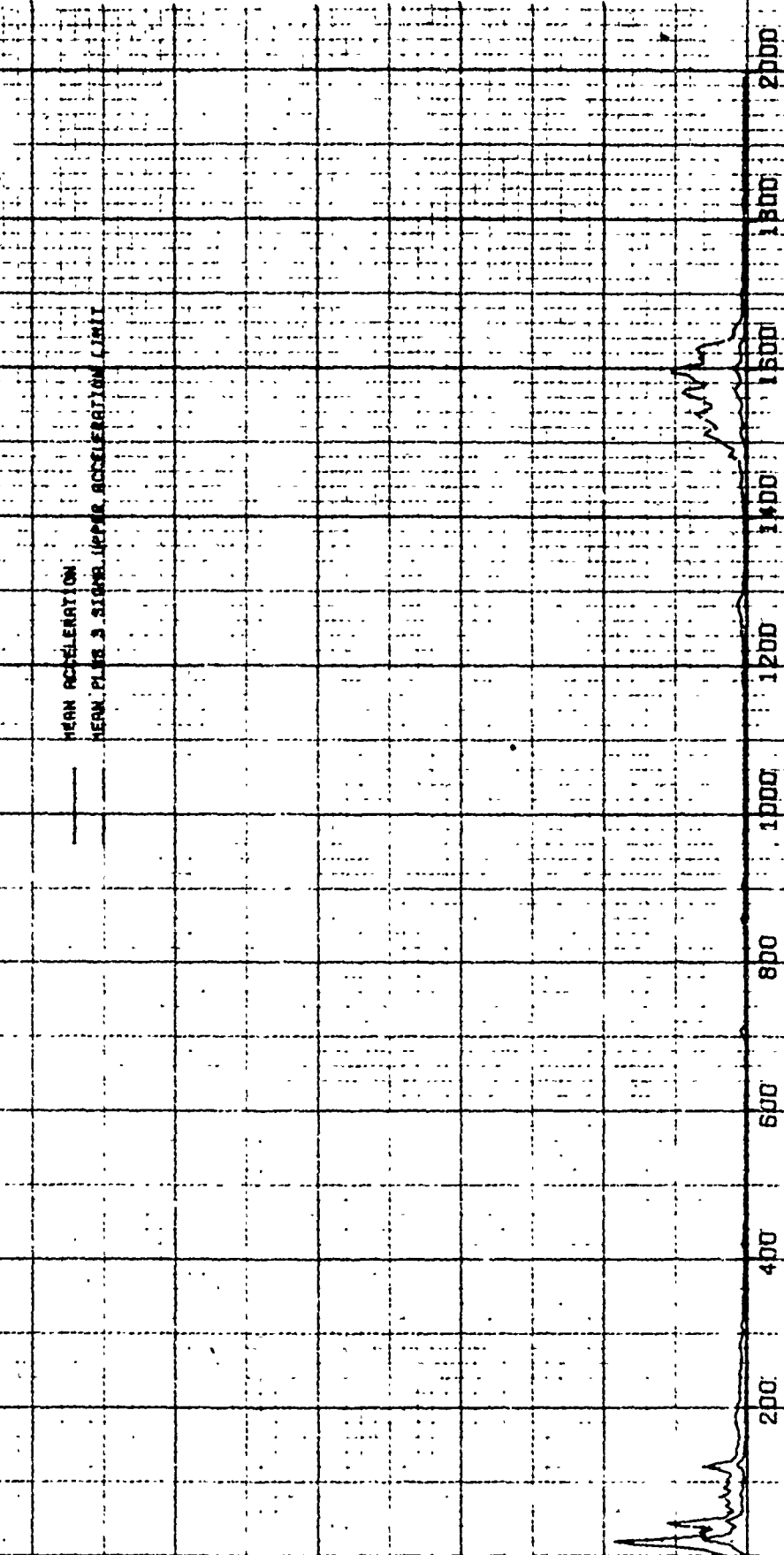

FIG 56
COMPRESSED VIBRATION DATA MAXIMUM ACCELERATION

CH-47C USA 67N 68-17126
A/C CONFIG-COMB CLEAN, SLING AND INTERNAL LOAD
FLT COND-COMB MANEUVERS
INSTR. PANEL COMB AXIS-SENSOR LOC 1.2.3.4.5.6.7
COMPRESSION PASS NO.1 VIB PLOT 006

ONE HALF PEAK TO PEAK ACCELERATION G

145

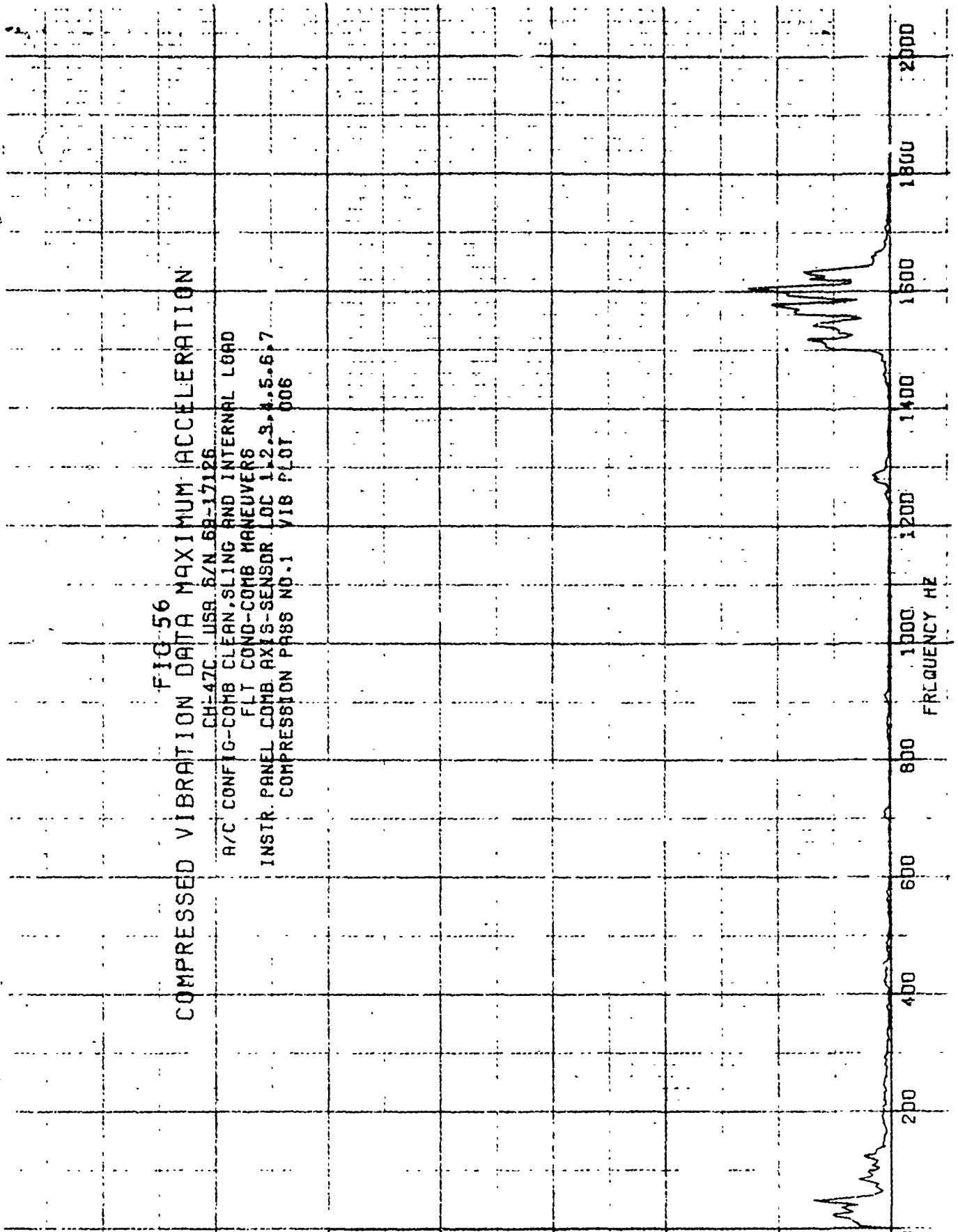

FIG 57

COMPRESSED VIBRATION DATA

CH-47C USA 6/N 68-17126
R/C CONFIG-COMB CLEAN, SITING AND INTERNAL LOAD
FLT COND-COMB MANEUVERS
INSTR PAR-EL COMB. AXIS-SENSOR LOC 1,2,3,4,5,6,7
COMPRESSION PASS NO.1 VIB PLOT 006

MEAN ACCELERATION
MEAN PLUS 3 SIGMA UPPER ACCELERATION LIMIT

ONE HALF PEAK TO PEAK ACCELERATION G
0.0 1.0 2.0 3.0 4.0 5.0

2000
1800
1600
1400
1200
1000
800
600
400
200
0
FREQUENCY HZ

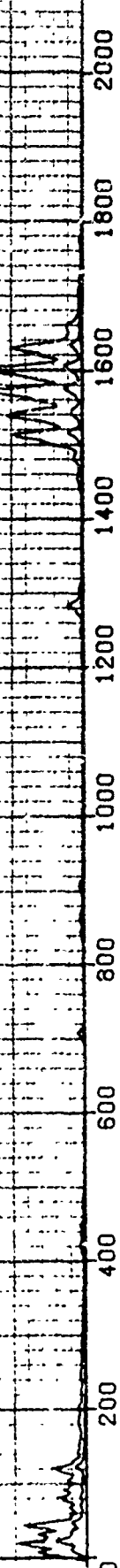
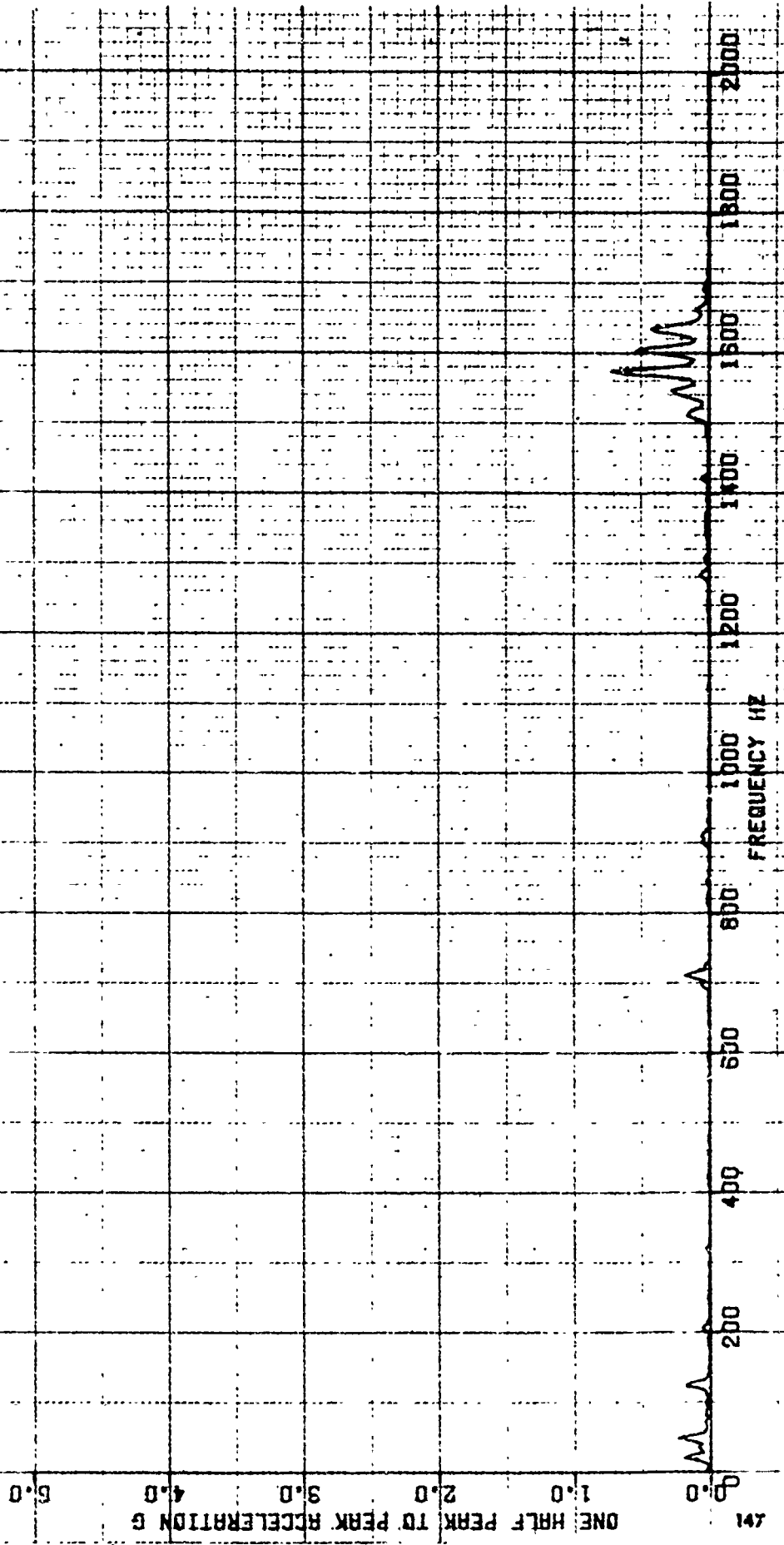

FIG 58 COMPRESSED VIBRATION DATA MAXIMUM ACCELERATION

CH-57C USS ZAL 58-17126
A/C CONFIG-7388 CLEAN, LING AND INTERNAL LOAD
AND RUN-COMB FLT AND CNO IDLE
INSTR PANEL COMB AX18-SENSEY LOC 1.2.3.4.5.6.7
COMPRESSION PASS NO.1 VIB PLOT 007



ONE HALF PEAK TO PEAK ACCELERATION G

FREQUENCY HZ

FIG 59
COMPRESSED VIBRATION DATA

CH-47C USA 8/N 89-17126
A/C CONFIG-COMB CLEAN, SLING AND INTERNAL LOAD
AND RUN-COMB FLT AND GND IDLE
INSTK PANEL COMB AXIS-SENSOR LOC 1-2, 3, 4, 5, 6, 7
COMPRESSION PASS NO. 1 VIB PLOT 007

NON-ACCELERATION
NON-FLY 3.5 MIN. UPPER ACCELERATION LIMIT

0.5
1.0
2.0
3.0
4.0
5.0

ONE HALF PERCENT PEAK ACCELERATION G

200 400 600 800 1000 1200 1400 1600 1800 2000
FREQUENCY HZ

W.A.

FIG 60
COMPRESSED VIBRATION DATA MAXIMUM ACCELERATION

CH-47C USA S/N 69-17126

A/C CONFIG-COMB CLEAN-SLING AND INTERNAL LOAD
FLT COND-HOVER

AVIONICS LOW FREQ EQUIP COMB AXIS-SENSOR LOC B.9.10.11.11
COMPRESSION PASS NO.1 VIB PLOT 008

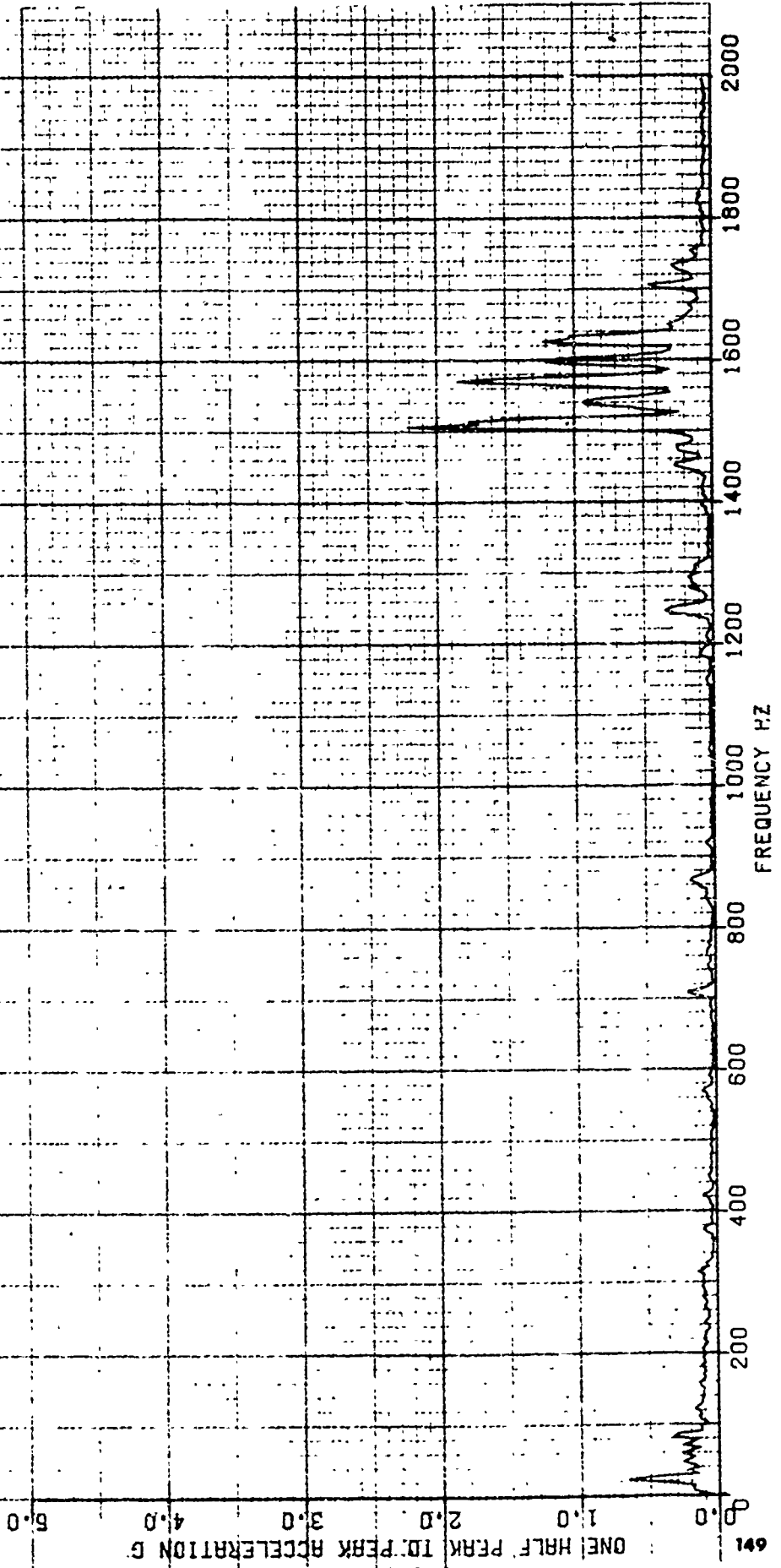

FIG 61

COMPRESSED VIBRATION DATA

CH-47C USA S/N 68-17126

R/C CONFIG-COMB CLEAN, SLING AND INTERNAL LOAD

FLT COND-HOVER

AVIONICS LON FREQ EQUIP COMB AXIS-SENSOR LOC 8.9.10.11.12

COMPRESSION PASS NO.1 VIB PLOT 008

ONE HALF PEAK TO PEAK ACCELERATION G

MEAN ACCELERATION
MEAN PLR 3 STAGE UPPER ACCELERATION LIMIT

200 400 600 800 1000 1200 1400 1600 1800 2000
FREQUENCY HZ

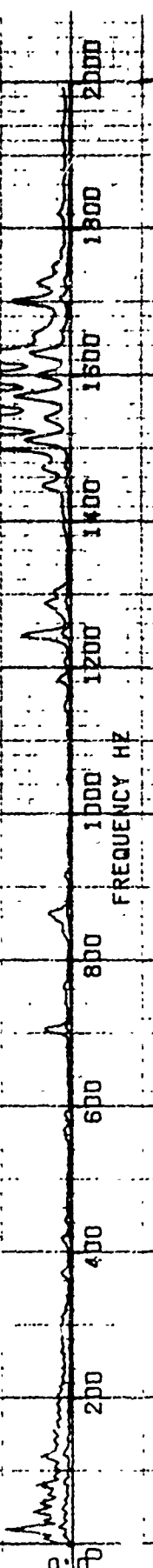

FIG 62
COMPRESSED VIBRATION DATA MAXIMUM ACCELERATION
CH-47C USA 6/N 68-17126
A/C CONFIG-COMB CLEAN, SLING AND INTERNAL LOAD
FLI COND-LEVEL FLY
AVIONICS LOW FREQ EQUIP COMB AXIS-SENSOR LOC B.9.10.11.11.11
COMPRESSION PASS NO.1 VIB PLOT 009

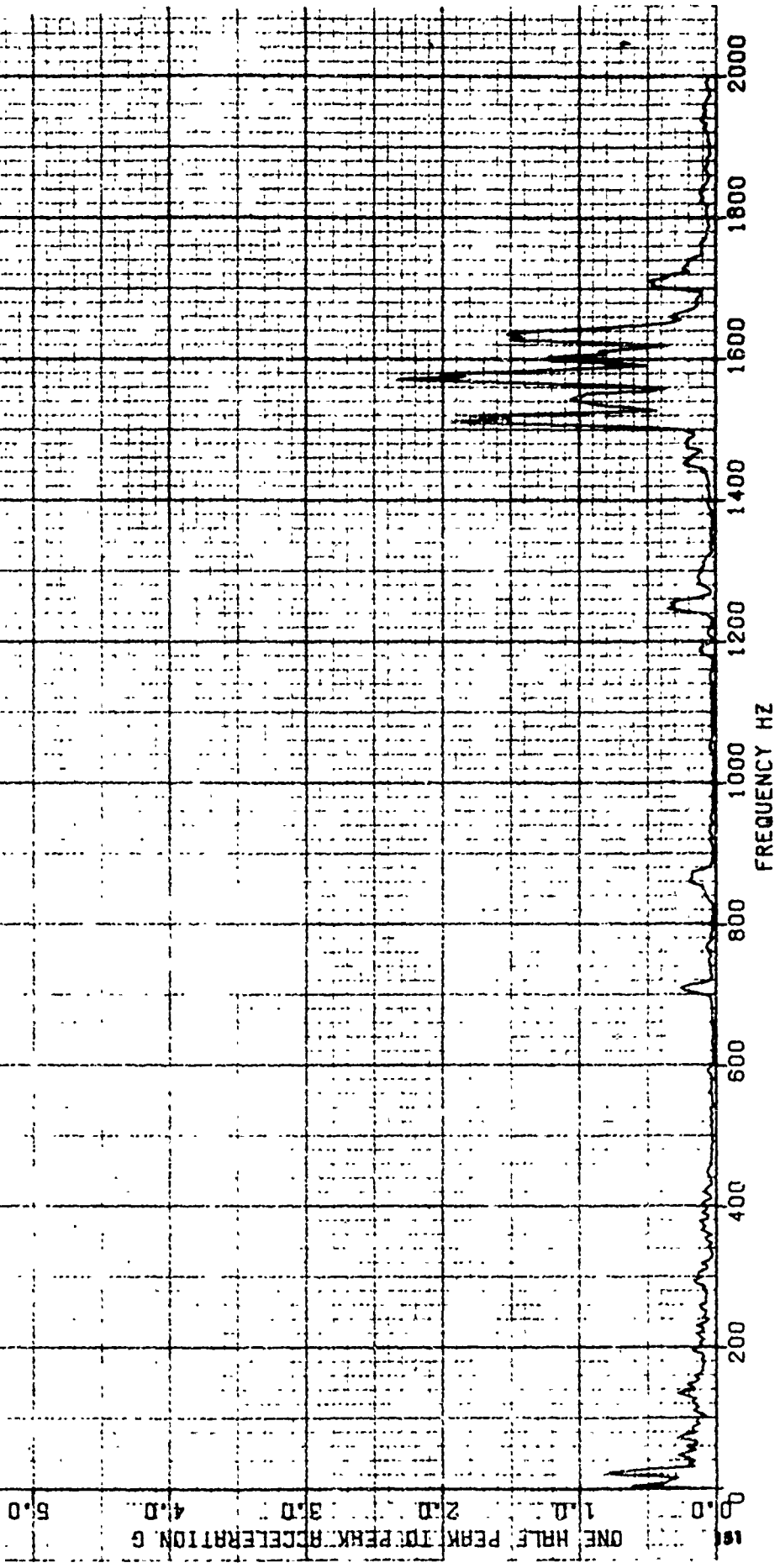

FIG 63

COMPRESSED VIBRATION DATA

CH-47C USA S/N 68-17126
A/C CONFIG-COMB CLEAN-SLING AND INTERNAL LOAD
FLT COND-LEVEL FLT
AVIONICS LOW FREQ EQUIP. COMB. AXIS-SENSOR LOC 8.8.10.11.11.4
COMPRESSION PRSS: NO. 1 VIB PLOT 009

Y-AXIS: ACCELERATION
X-AXIS: FREQ. UPPER ACCELERATION ONLY

ONE HALF PEAK TO PEAK ACCELERATION G
5.0
4.0
3.0
2.0
1.0
0.0

200 400 600 800 1000 1200 1400 1600 1800 2000
FREQUENCY HZ

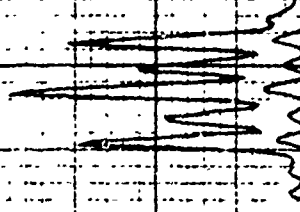

FIG 64
COMPRESSED VIBRATION DATA MAXIMUM ACCELERATION

CH-47C USA S/N 68-17126
A/C CONFIG-COMB CLEAN-SLING AND INTERNAL LOAD
FLT COND-CRIMP
AVIONICS LOW FREQ EQUIP COMB AXIS-SENSOR LOC B.B.10.11.14
COMPRESSION PASS NO.1 VIB PLOT 010

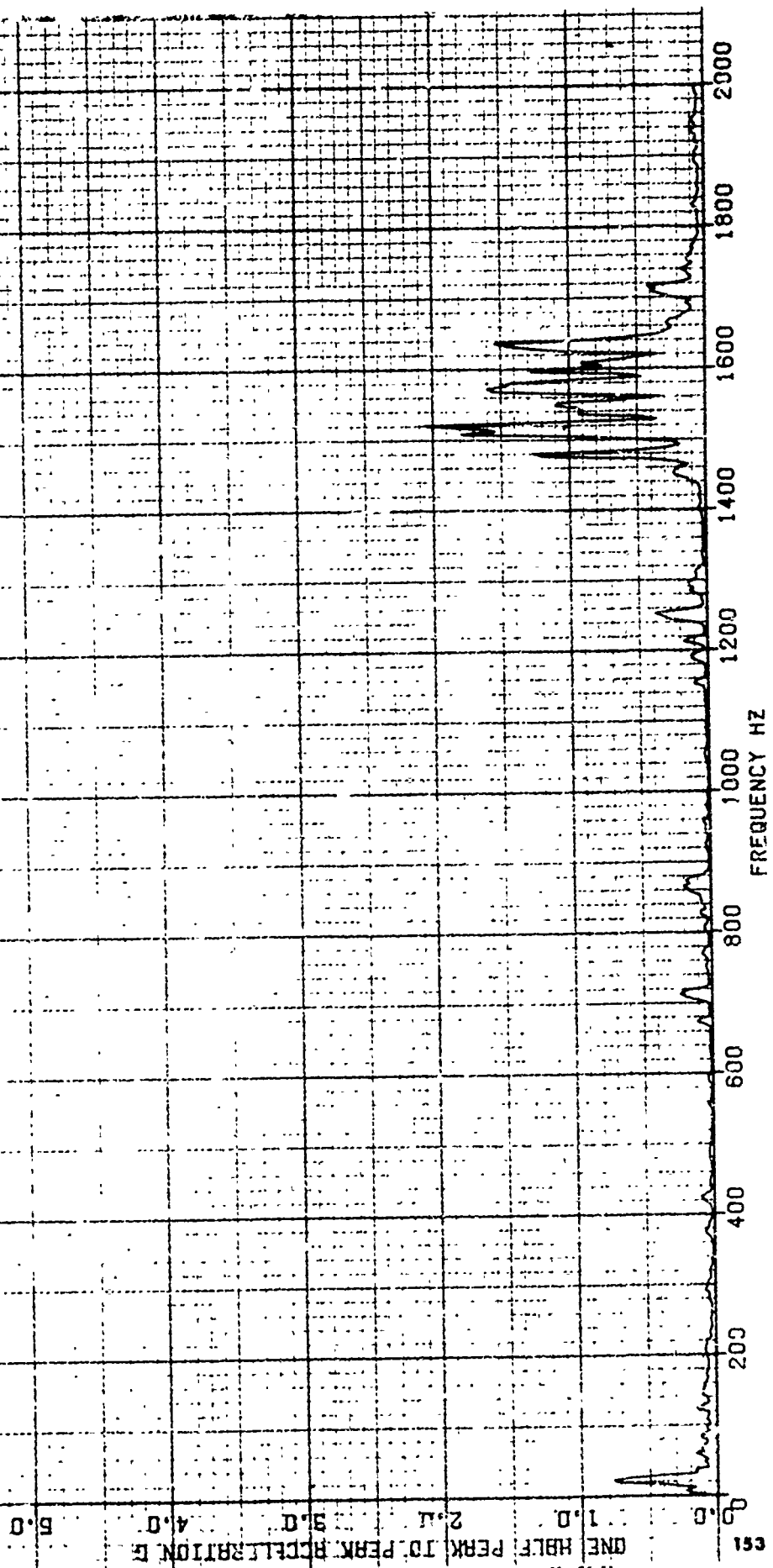

FIG. 65 COMPRESSED VIBRATION DATA

CHL47C USA 5/N 58-17126
A/C CONFIG-COMB CLEAN SLING AND INTERNAL LOAD
FLT COND-CLIMB
AVIONICS ON FREQ EQUIP. COMB AXIS--SENSOR LOC 8, 9, 10, 11, 12
COMPRESSION PASS NO. 1 VIB PLOT 010

100% ACCELERATION
100% PLG & 100% UPPER ATTENUATION LIMIT

ONE HALF PEAK TO PEAK ACCELERATION G
5.0
4.0
3.0
2.0
1.0
0.0

FREQUENCY HZ

200 400 600 800 1000 1200 1400 1600 1800 2000

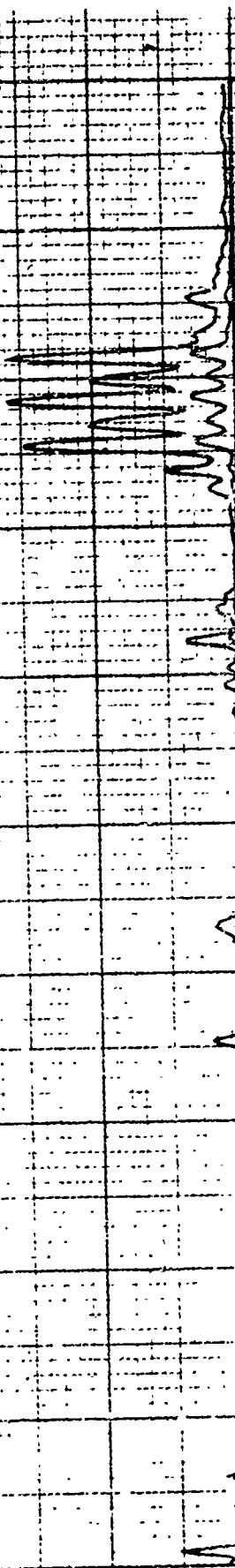

FIG 66
COMPRESSED VIBRATION DATA MAXIMUM ACCELERATION
CH-47C USA 8/N 68-17126
A/C CONFIG-COMB CLEAN-SLING AND INTERNAL LOAD
FLT COND-DESCENT
AVIONICS LOW FREQ EQUIP COMB AXIS-SENSOR LOC 8-8.10.11.14
COMPRESSION PASS NO.1 VIB PLOT 011

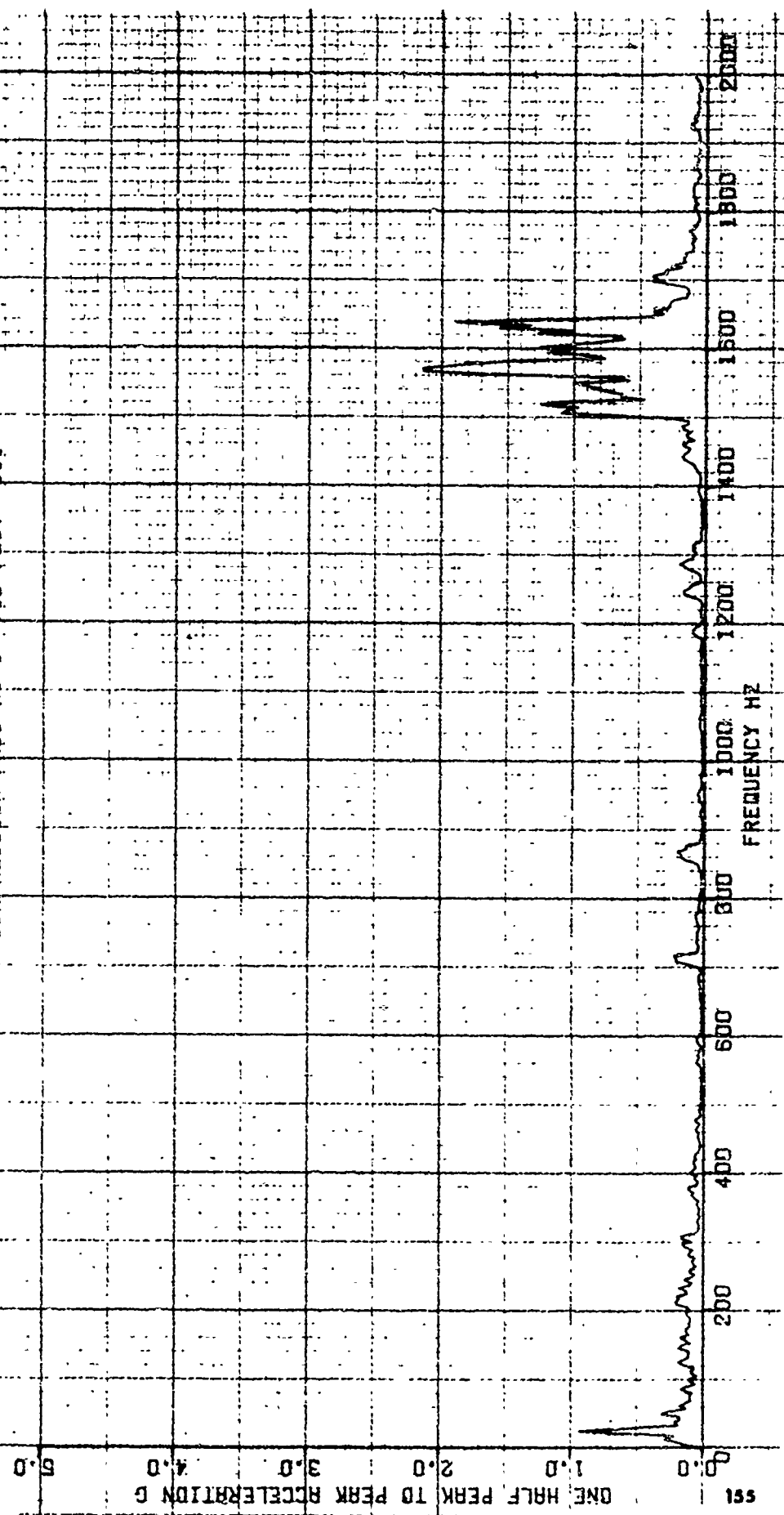

FIG 67 COMPRESSED VIBRATION DATA

CH 47C USB 8/2N 68-17126
A/C CONFIG-COMB CLEAN, SLING AND INTERNAL LOAD
FLT COND-DESCENT
AVIONICS LOW FREQ EQUIP. COMB. AXIS-SENSOR LDC 8.9.10.11.14
COMPRESSION PASS NO. 1 VIB PLOT 011

MAIN ACCELERATION
FROM PL 81 8.91008 UPPER ACCELERATION LIMIT?

ONE HALF PEAK TO PEAK ACCELERATION G
5.0
4.0
3.0
2.0
1.0
0

2000
1800
1600
1400
1200
1000
800
600
400
200
0

FREQUENCY HZ

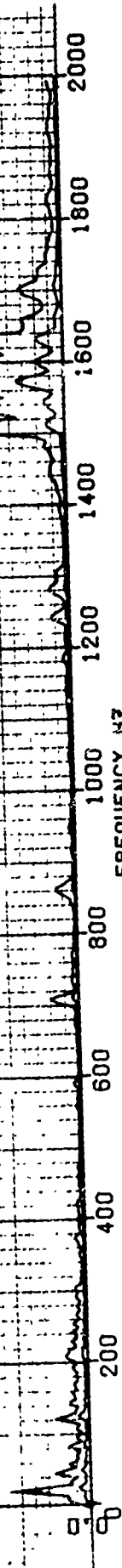

FIG 6B
COMPRESSED VIBRATION DATA MAXIMUM ACCELERATION

CH-47C USA S/N 69-17128
R/C CONFIG-COMB CLEAN SLING AND INTERNAL LOAD
FLT COND-COMB T70 AND LOGS
AVIGNICS LOW FREQ EQUIP COMB AXIS-SENSOR LOC 8.8.10.11514
COMPRESSION PASS NO.1 VIB PLOT 012

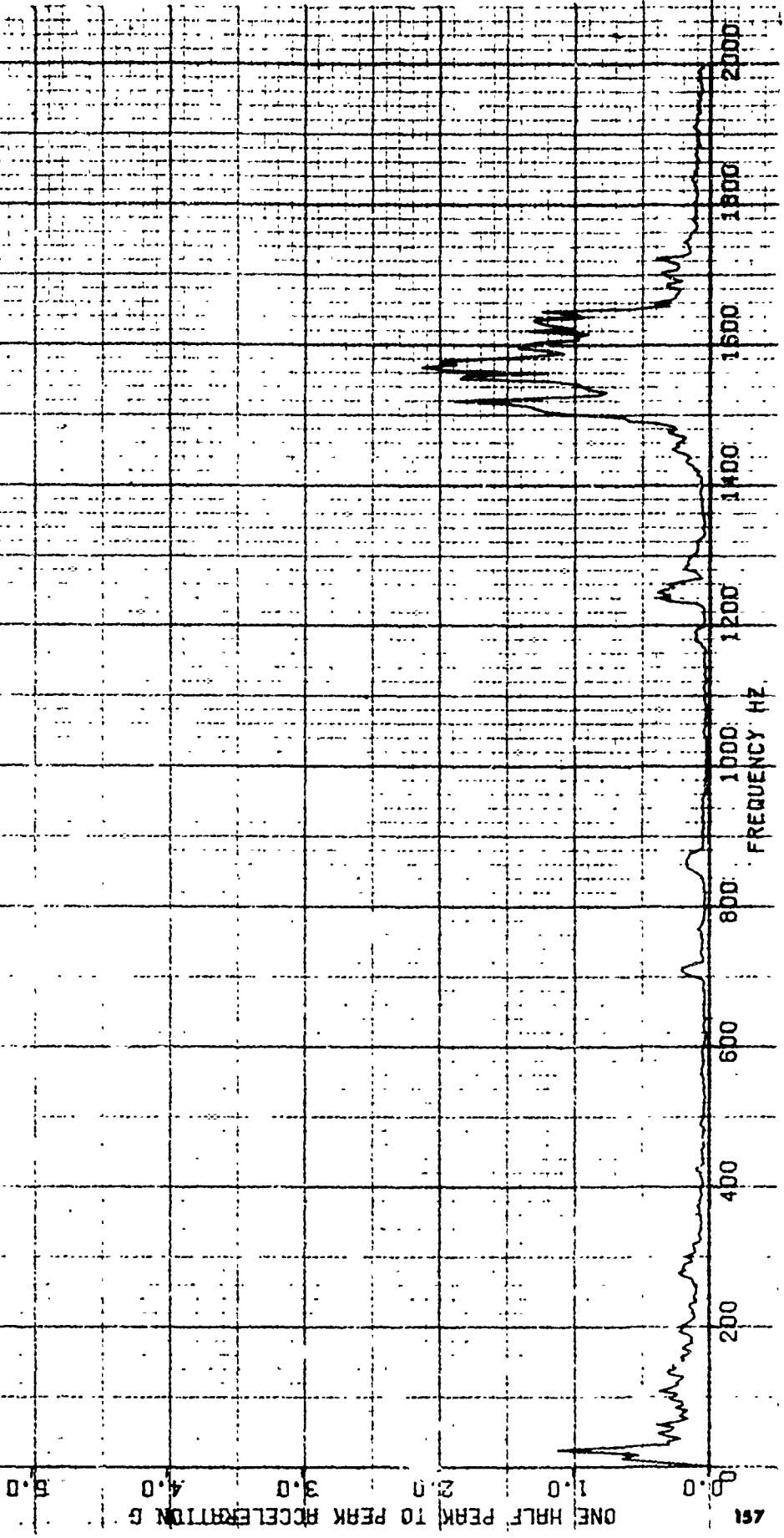

FIG 69 COMPRESSED VIBRATION DATA

CH-47C USAF S/N 68-17126
 A/C CONFIG-COMB CLEAN, SLING AND INTERNAL LOAD
 FLT COND-COMB TVO AND LDGS
 AVIONICS, LOW FREQ EQUIP, COMB, AXIS-SENSOR, LOC 8.9.10.11.14.
 COMPRESSION PASS NO.1 VIB PLOT 012.

MEAN ACCELERATION
 MEAN PLUS 3 SIGMA UPPER ACCELERATION LIMIT

ONE HALF PEAK TO PEAK ACCELERATION G

FREQUENCY HZ

200 400 600 800 1000 1200 1400 1600 1800 2000

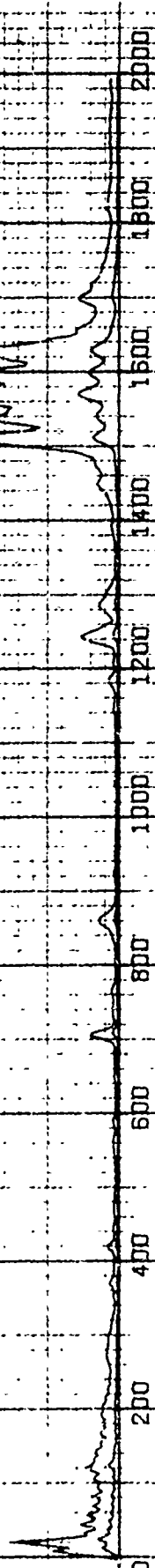

FIG 70
COMPRESSED VIBRATION DATA MAXIMUM ACCELERATION
CH-47C USA 69-17126
A/C CONFIG-COMB CLEAN SLING AND INTERNAL LOAD
FLT COND-COMB MANEUVERS
AVIONICS LOW FREQ EQUIP. COMB AXIS-SENSOR LOC 8.9.10.11.14
COMPRESSION PASS NO-1 VIB PLOT 013

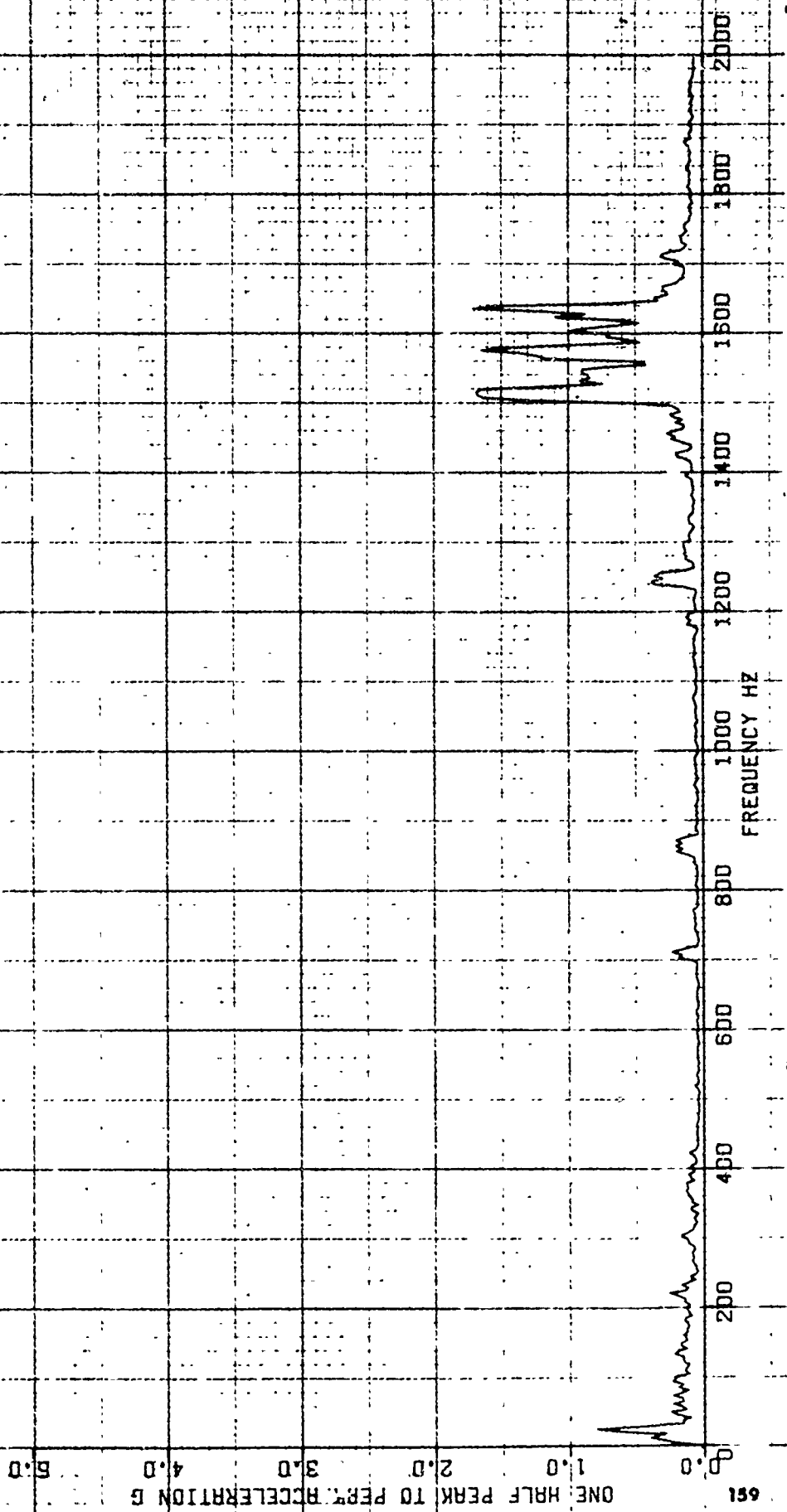

FIG 51 COMPRESSED VIBRATION DATA

CH-47C USA S/N 68-17126
A/C CONFIG-COMB CLEAN, SLING AND INTERNAL LOAD
FLT COND-COMB MANEUVERS
AVIDONICS LOW FREQ EQUIP COMB AXIS-SENSOR LOC 8.9.10.11.14
COMPRESSION PASS NO.1 VIB PLOT 013

— MEAN ACCELERATION
— MEAN PLUS 3 SIGMA UPPER ACCELERATION LIMIT

ONE HALF PEAK TO PEAK ACCELERATION G

FREQUENCY HZ

2000

1800

1600

1400

1200

1000

800

600

400

200

0

5.0

4.0

3.0

2.0

1.0

0

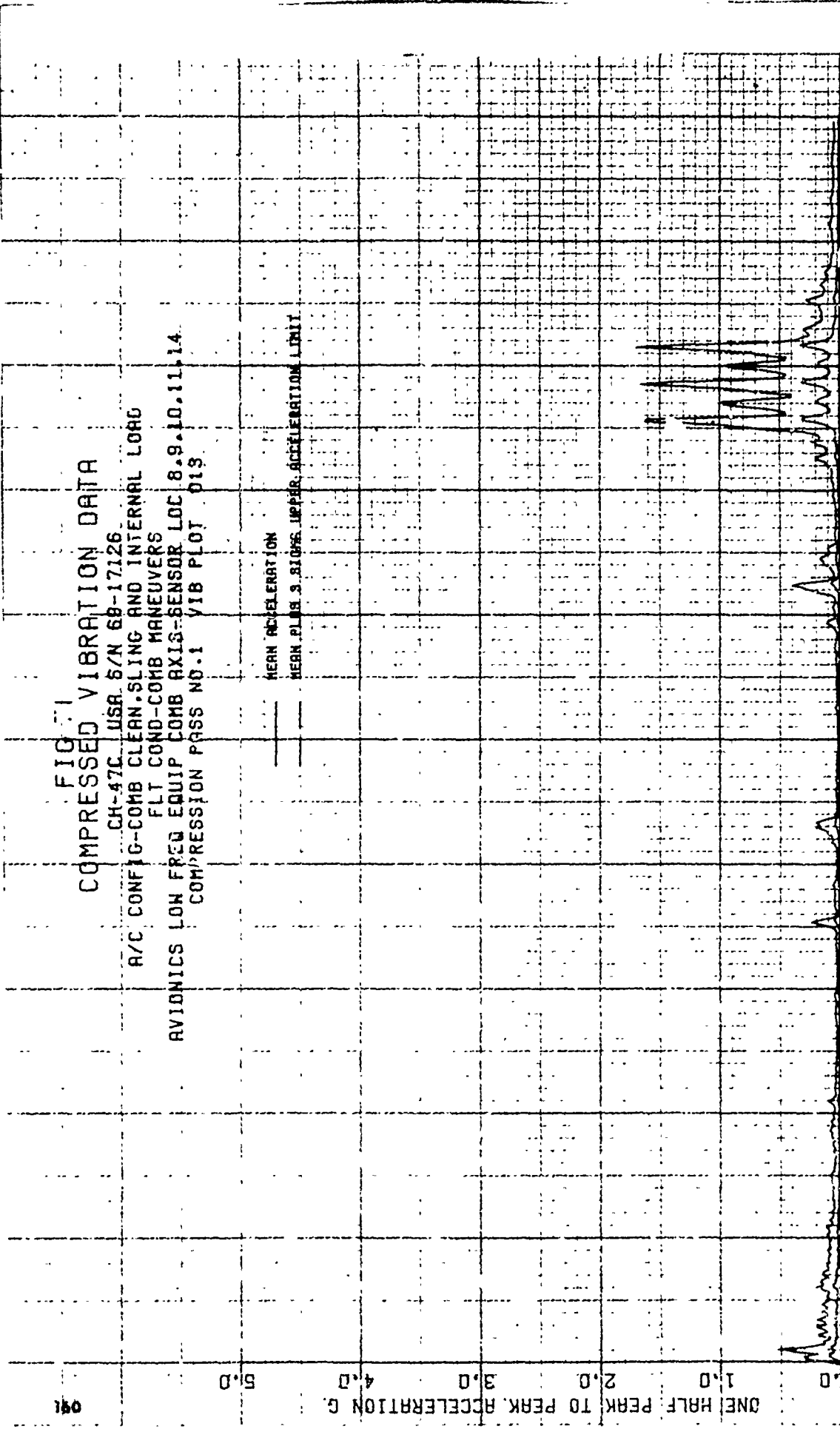

FIG 72
COMPRESSED VIBRATION DATA MAXIMUM ACCELERATION

CH-47C USA S/N 68-17126
A/C: CONFIG-COMB CLEAN, SLING AND INTERNAL LOAD
GND RUN-COMB FLT AND GND IDLE
AVIONICS LOW FREQ. EQUIP. COMB. AXIS-SENSOR LOC. 8.9.10.11.14
COMPRESSION PASS NO.1 VIB PLOT 014

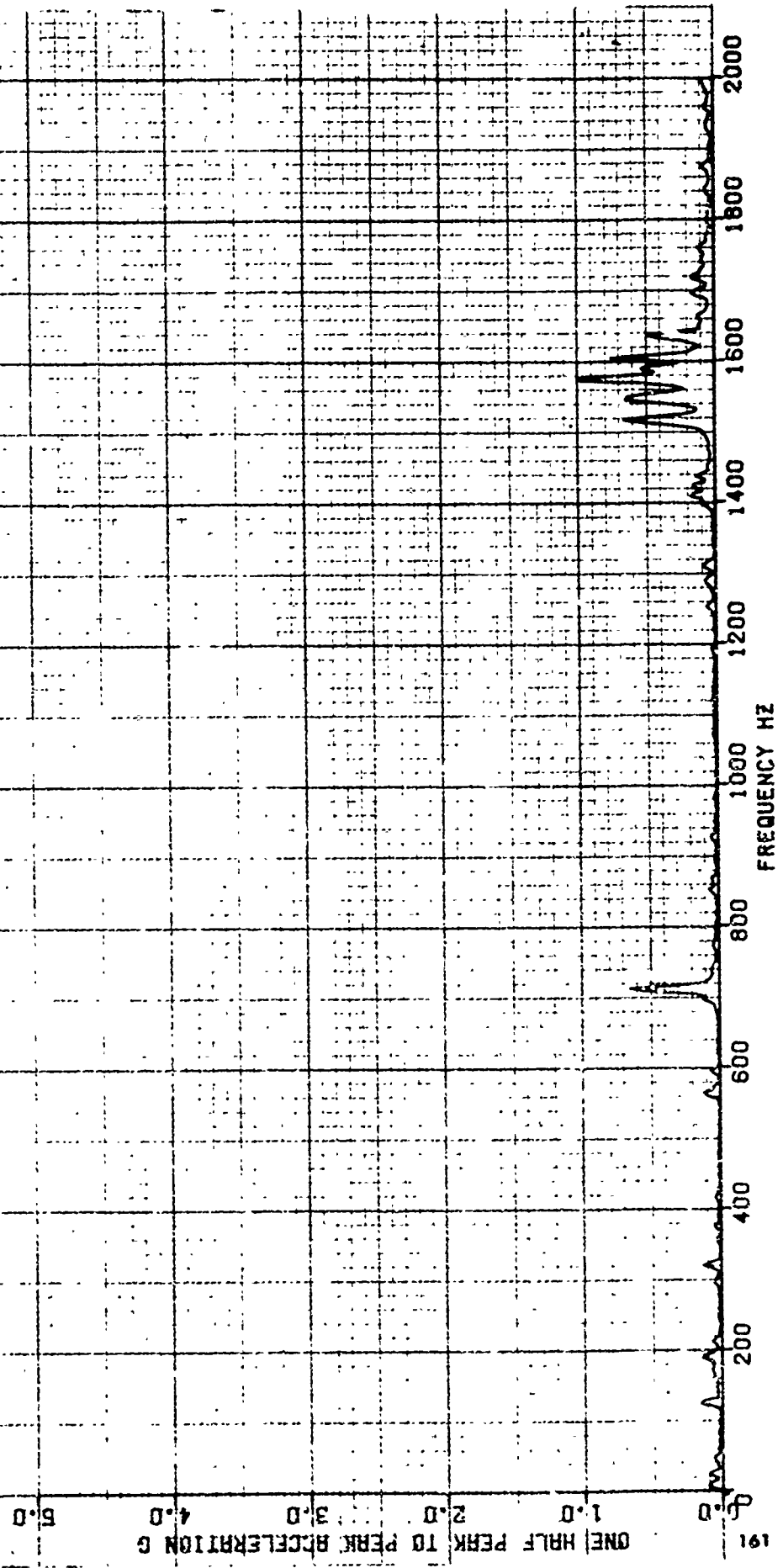

FIG 73

COMPRESSED VIBRATION DATA

CH-47C USAF S/N 68-17126

R/C CONFIG-COMB CLEAN-SLING AND INTERNAL LOAD
GND RUN-COMB FLT AND GND IDLE

AVIONICS LOW FREQ EQUIP. COMB. AXIS-SENSOR LOC. BLS. 10.111.1A
COMPRESSION PASS NO. 1 VIB PLOT 014

MAIN ACCELERATION
SENS. PLAN 3 ALONG UPPER ACCELERATION AXIS

291

5.0

ONE HALF PEAK TO PEAK ACCELERATION G
1.0
2.0
3.0
4.0

0.0

200 400 600 800 1000 1200 1400 1600 1800 2000
FREQUENCY HZ

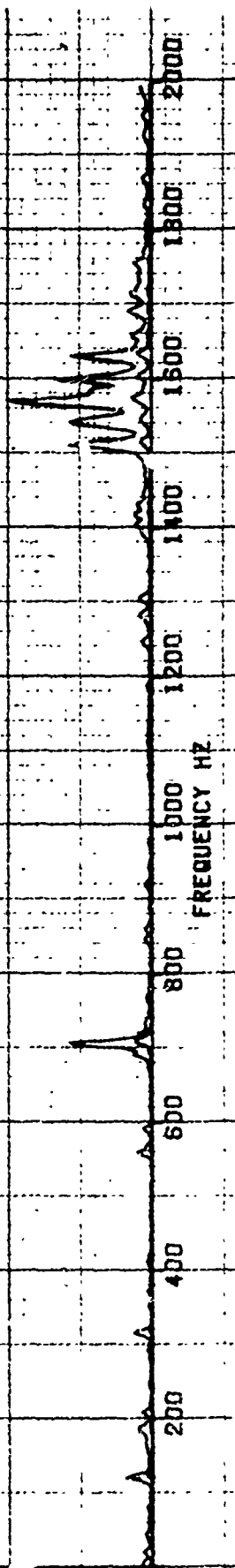

FIG 74
COMPRESSED VIBRATION DATA MAXIMUM ACCELERATION

CH-47C USA S/N 68-17126
A/C CONFIG-COMB CLEAN, SLING AND INTERNAL LOAD
FLT COND-HOVER
AVIONICS HIGH FREQ EQUIP. COMB. AXIS-SENSOR LOC. L2.13
COMPRESSION PASS NO. 1 VIB PLOT 016

ONE HALF PEAK TO PEAK ACCELERATION G
5.0
4.0
3.0
2.0
1.0
0

FREQUENCY Hz
200 400 600 800 1000 1200 1400 1600 1800 2000

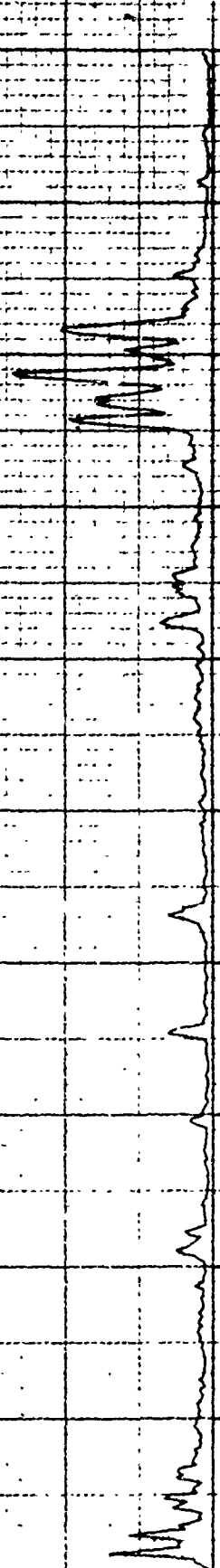

Fig 75 COMPRESSED VIBRATION DATA

CH-47C USA S/N 68-17126
R/C CONFIG-COMB CLEAN, SLING AND INTERNAL LOAD
FLT COND: HOVER
AVIONICS HIGH FREQ EQUIP COMB. AXIS-SENSOR LOC 12, 18
COMPRESSION PASS NO. 1 VIB PLOT 015

MEAN ACCELERATION
MEAN PLUS 2 SIGMA UPPER ACCELERATION LIMIT

ONE HALF PEAK TO PEAK ACCELERATION G

FREQUENCY Hz

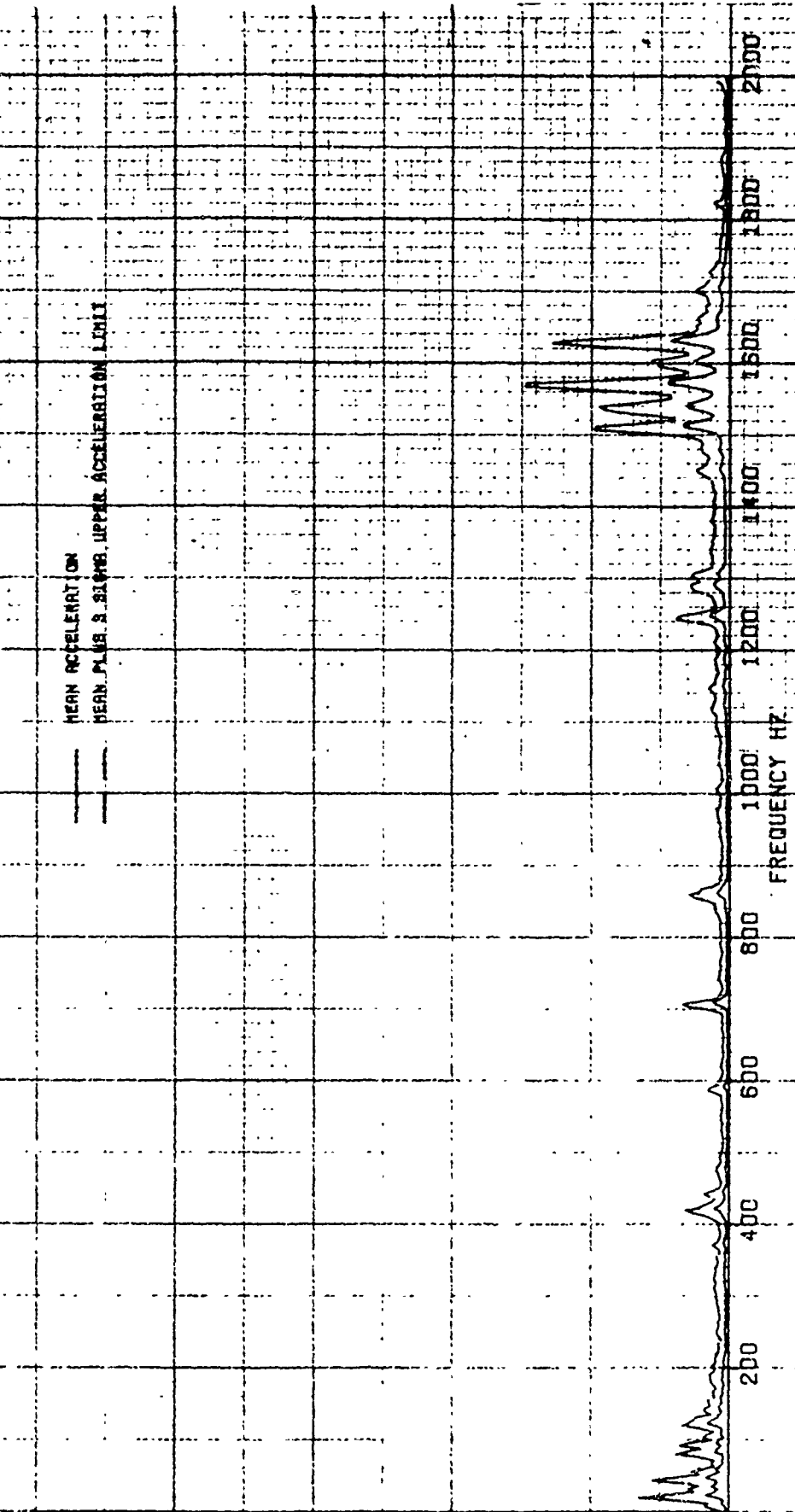

FIG 76
COMPRESSED VIBRATION DATA MAXIMUM ACCELERATION

CH-47C USAF S/N 68-17126
A/C CONFIG-COMB CLEAN, SLING AND INTERNAL LOAD
FLT COND-LEVEL FLT
AVIONICS HIGH FREQ EQUIP COMB AXIS-SENSOR LOC 12-13
COMPRESSION PASS NO.1 VIB PLOT 018

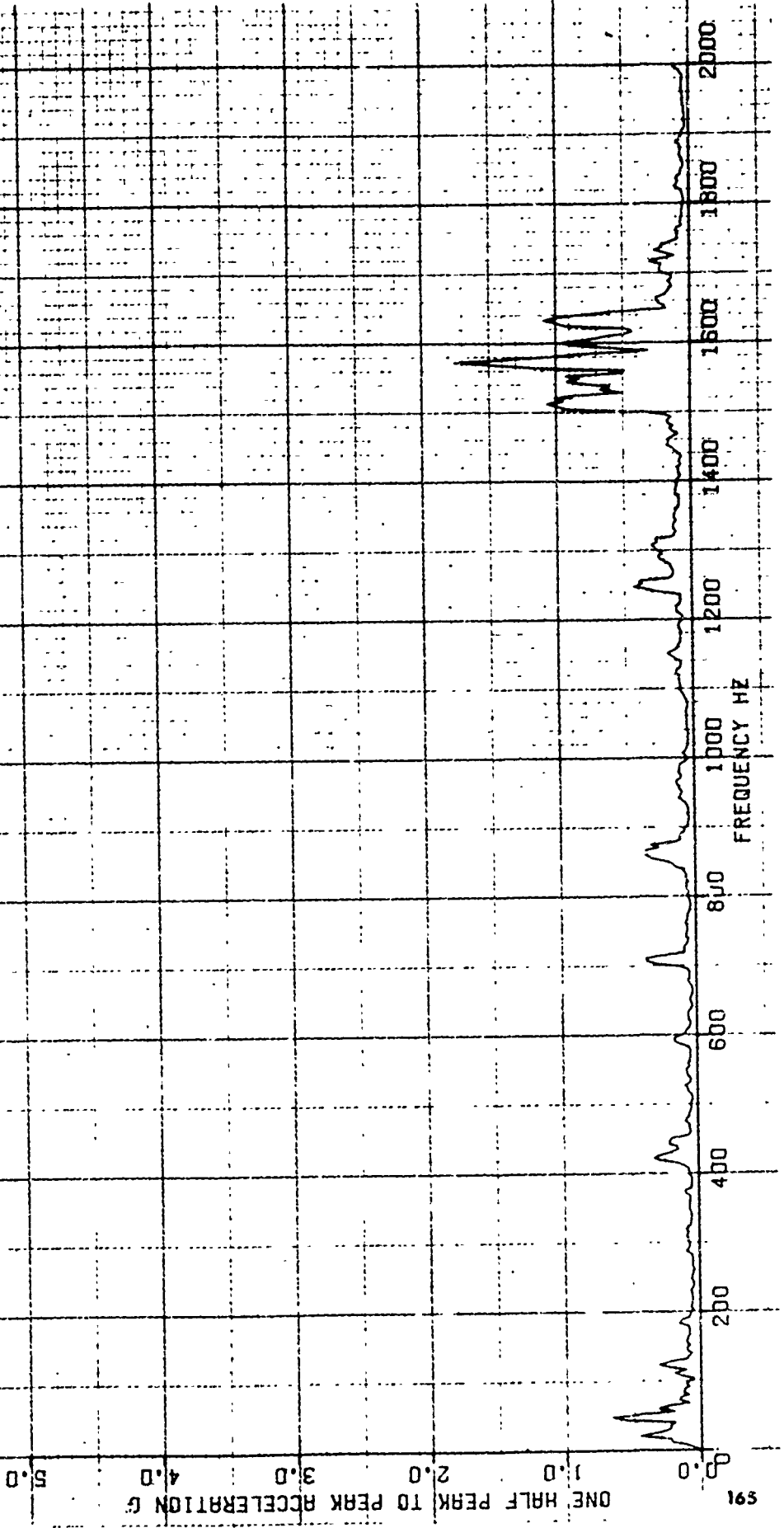

FIG. 77 COMPRESSED VIBRATION DATA

CH-47C USA S/N 68-17126
A/C CONFIG-COHB CLEAN, SLING AND INTERNAL LOAD
FLT COND-LEVEL FLY
AVIONICS HIGH FREQ EQUIP. COMB. AXIS-SENSOR LDC 12.13
COMPRESSION PASS NO.1 VIB. PLOT 016

MEAN ACCELERATION
MEAN PLUS 3 SIGMA UPPER ACCELERATION LIMIT

ONE HALF PEAK TO PEAK ACCELERATION G

5.0
4.0
3.0
2.0
1.0
0.0

200 400 600 800 1000 1200 1400 1500 1800 2000
FREQUENCY HZ

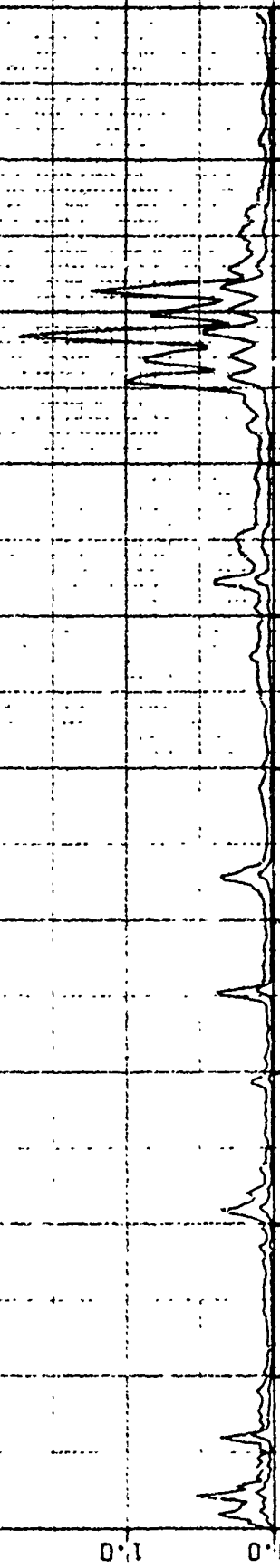

FIG 78
COMPRESSED VIBRATION DATA MAXIMUM ACCELERATION

CH-47C USA 67N 68-17126
R/C CONFIG-COMB CLEAN, SLING AND INTERNAL LOAD
FLT COND-CLIMB
AVIDONICS HIGH FREQ EQUIP COMB. AXIS-SENSOR LOC 12.13
COMPRESSION PASS NO.1 VIB PLOT 017

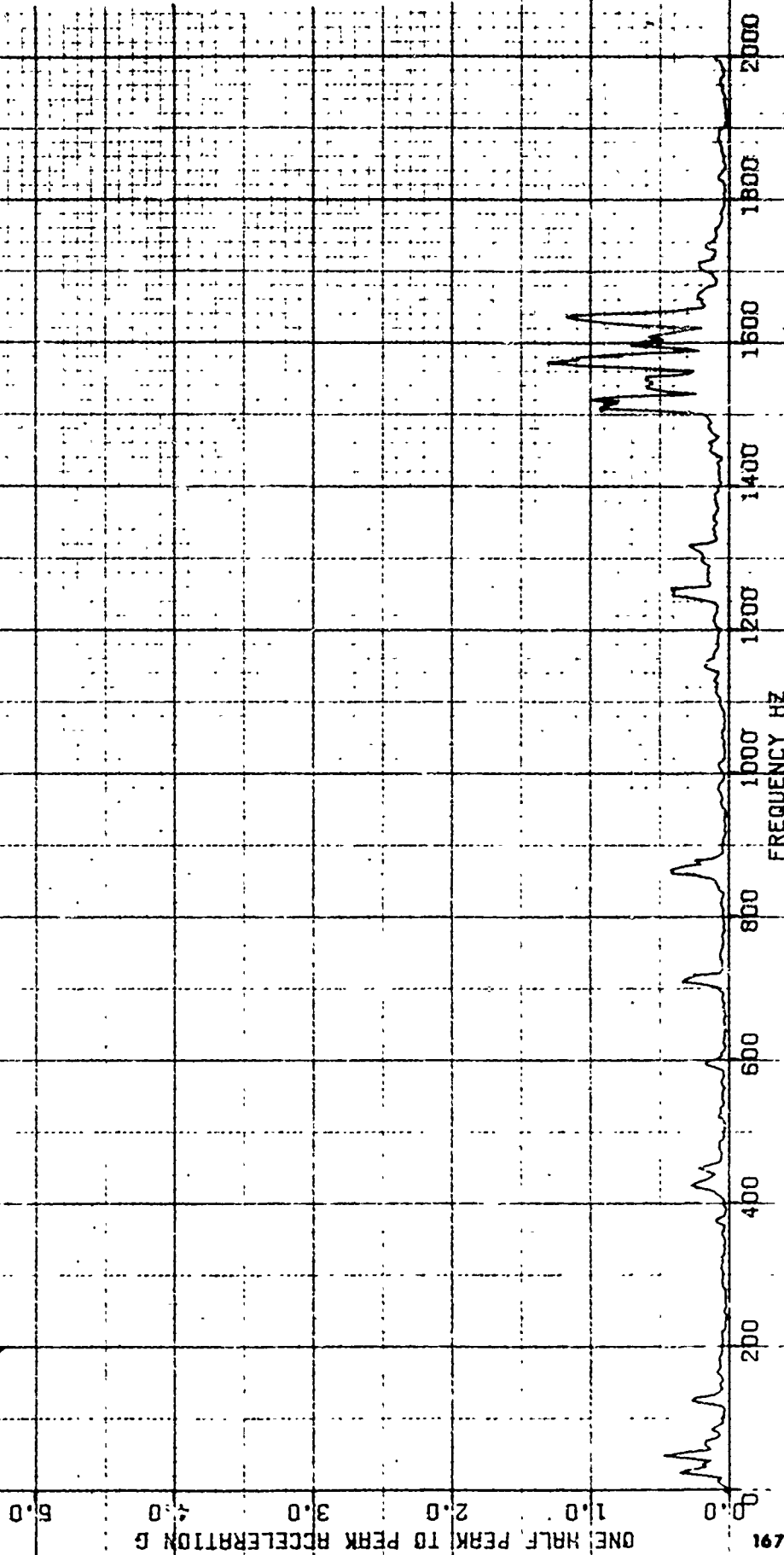

FIG 79
COMPRESSED VIBRATION DATA

CH-47C USR 5/N 68-17126
A/C CONFIG-COMB CLRN,SLING AND INTERNAL LOAD
FLT COND-CLIMB
AVIONICS HIGH FREQ EQUIP COMB AXIS-SENSOR LDC 12.15
COMPRESSION PASS NO.1 W/B PLOT 017

MEMO ACCELERATION
MEMO PLUS 3 SIGMA UPPER ACCELERATION LIMIT

ONE HALF PEAK TO PEAK ACCELERATION G
5.0
4.0
3.0
2.0
1.0
0.0

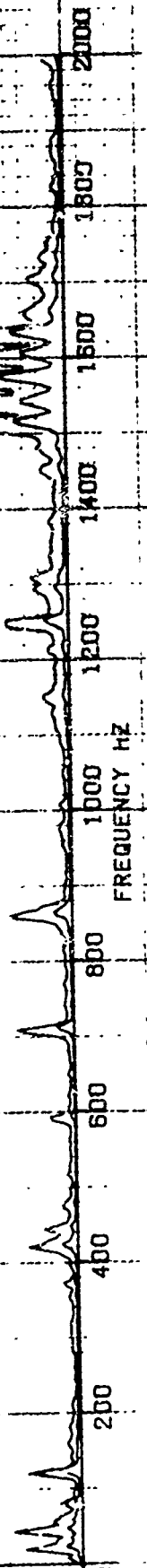

FIG 00
COMPRESSED VIBRATION DATA MAXIMUM ACCELERATION

CH-47C U68 62N 68-17126
A/C CONFIG-COMB CLEAN, SLING AND INTERNAL LOAD
FLT. COND-DESCENT
AVIONICS HIGH FREQ EQUIP COMB AXIS-SENSOR LOC 12-13
COMPRESSION PASS NO.1 VIB PLDT D18

91
ONE HALF PEAK TO PEAK ACCELERATION G
5.0
4.0
3.0
2.0
1.0
0.0

2000
1800
1600
1400
1200
1000
800
600
400
200
FREQUENCY HZ

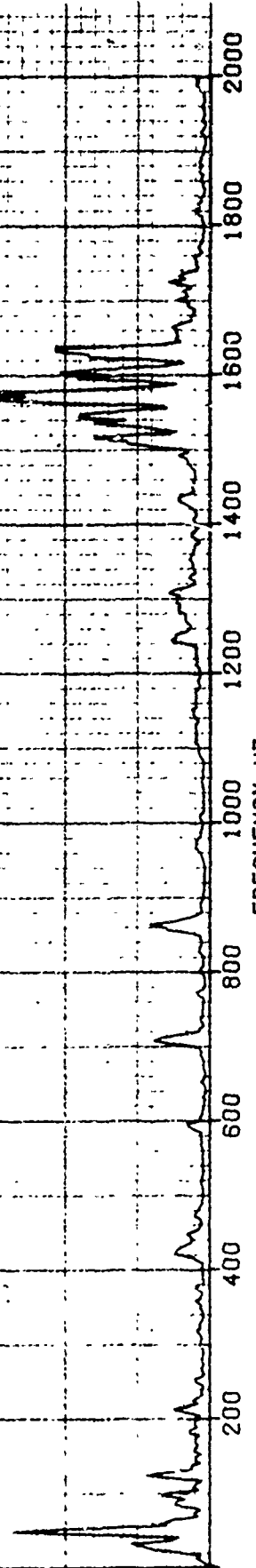

FIG. 81
COMPRESSED VIBRATION DATA

CH-47C USA S/N 68-17126
RYC CONFIG-COMB CLEAN-SLING AND INTERNAL LOAD
FLY COND-DESCENT
AVIONICS-HIGH FREQ EQUIP COMBLAKIS-SENSOR LOC 12.18
COMPRESSION PASS NO. 1 VIB PLOT 018

MEAN ACCELERATION
MEAN PLAS & SILVER UPPER ACCELERATION LIMIT

0.1

0.5

1.0

2.0

3.0

4.0

5.0

ONE HALF PEAK TO PEAK ACCELERATION G

0.0

200

400

600

800

1000

1200

1400

1600

1800

2000

FREQUENCY, HZ

1500

FIG 82
COMPRESSED VIBRATION DATA MAXIMUM ACCELERATION

CH-47C USA 6/N BR-17126
A/C CONFIG-COMB CLEAN SLING AND INTERNAL LOAD
FLT COND-COMB T/O AND LDGB
AMJONJ'S HIGH FREQ EQUIP COMB AXIS-SENSOR LOC 12-13
COMPRESSION PASS NO.1 VIB PLOT 019

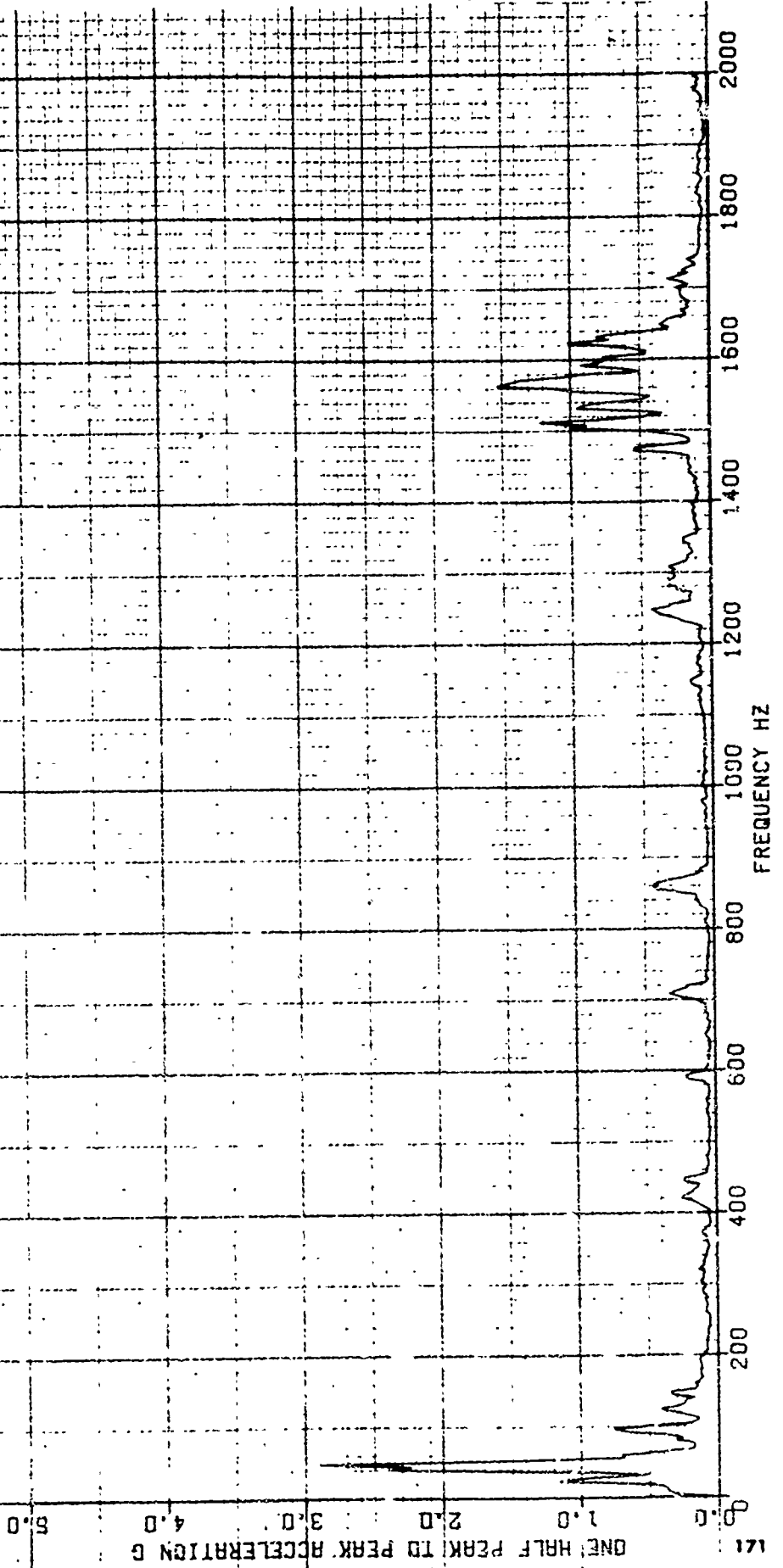

FIG 83

COMPRESSED VIBRATION DATA

CHE-47C USB S/N 6A-17126
A/C CONFIG-COMB CLEAN, SLING AND INTERNAL LOAD
FLT COND-COMR T/O AND LOGS
AVIONICS HIGH FREQ. EQUIP. OMB AXIS-SENSOR LOC. 12-13
COMPRESSION PASS NO. 1 VIB PLOT 019

MEAN ACCELERATION
MEAN PLUS 3 SIGMA UPPER ACCELERATION LIMIT

ONE HALF PEAK TO PEAK ACCELERATION G

FREQUENCY HZ

200 400 600 800 1000 1200 1400 1600 1800 2000

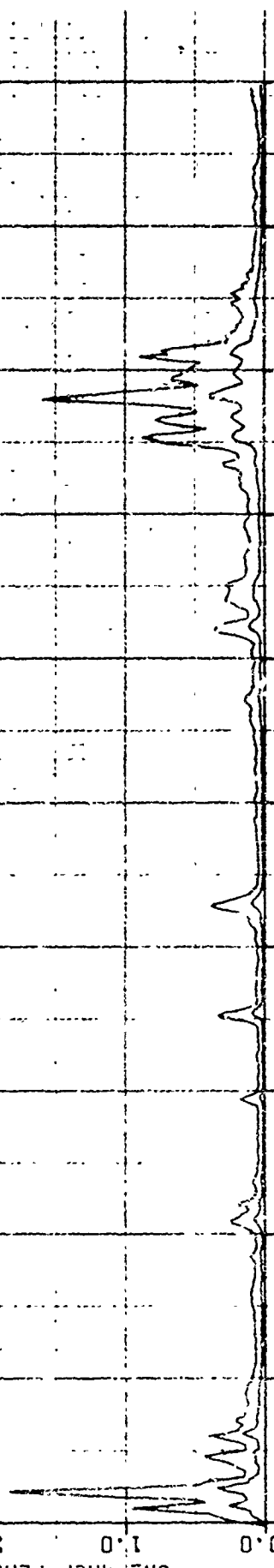

FIG 84
COMPRESSED VIBRATION DATA MAXIMUM ACCELERATION

CH-47C USA 67N 68-17126
R/C CONFIG-COMB CLEAN, SLING AND INTERNAL LOAD
FLT COND-COMB MANEUVERS
AMI UJCS HIGH FREQ EQUIP COMB AKIS-SENSOR LOC 12.19
COMPRESSION PASS ND.1 VIB PLOT 020

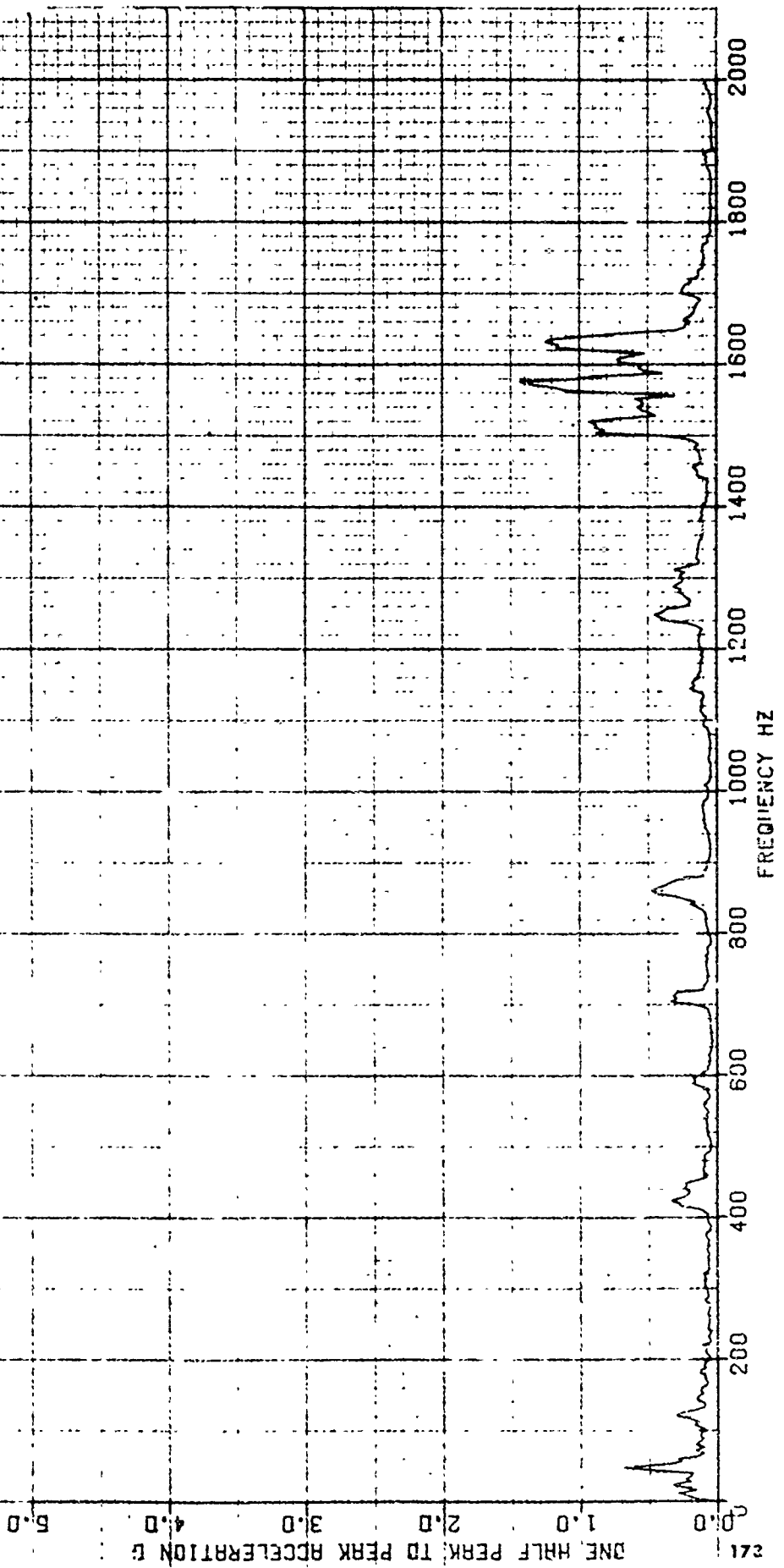

FIG 85 COMPRESSED VIBRATION DATA

CH-47C USAF S2-17126
 A/C CONFIG-COMB CLEAN, SLING AND INTERNAL LOAD
 FLT COND-COMB MANEUVERS
 AVIONICS HIGH FREQ EQUIP COMB. AXIS-SENSOR LOC 12.13
 COMPRESSION PASS NO.1 VIB PLOT 020

——— MEAN ACCELERATION
 - - - MEAN PLUS 3 SIGMA UPPER ACCELERATION LIMIT

ONE HALF PEAK TO PEAK ACCELERATION G
 5.0
 4.0
 3.0
 2.0
 1.0
 0.0

FREQUENCY HZ

200 400 600 800 1000 1200 1400 1500 1800 2000

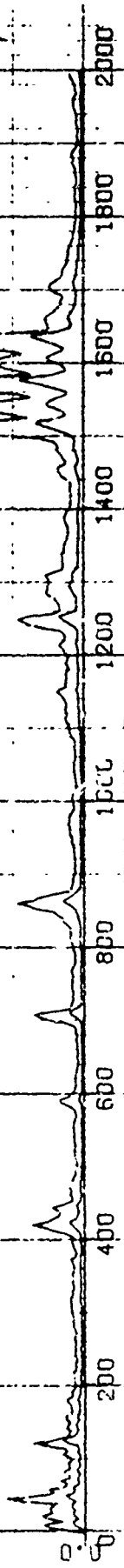
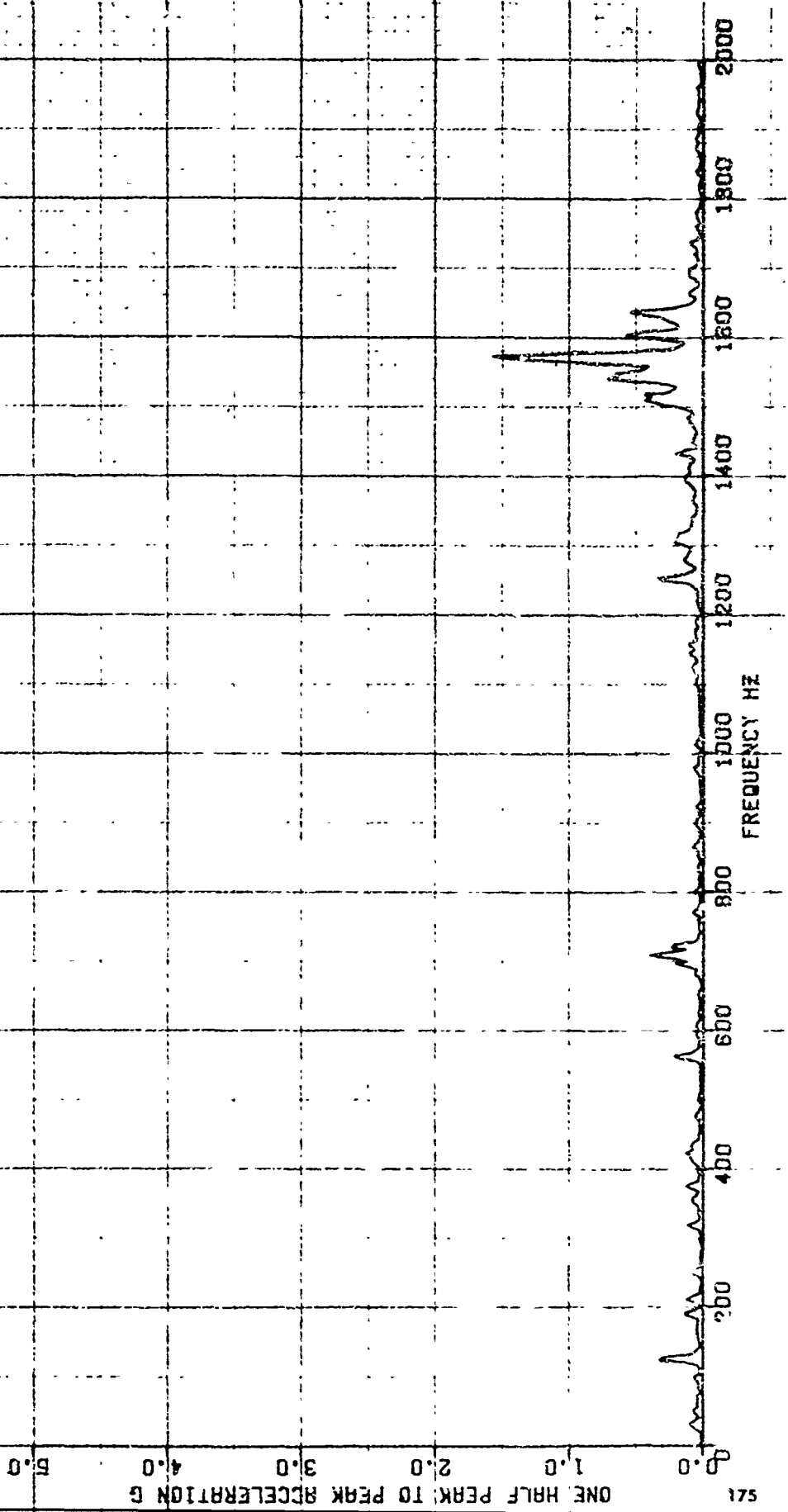

FIG 86
COMPRESSED VIBRATION DATA MAXIMUM ACCELERATION

CH-47C USA 5/N 58-17126
A/C CONFIG-COMB CLEAN,BLING AND INTERNAL LOAD
GND RUN-COMB FLT ANG GND IDLE
AVIONICS HIGH FREQ EQUIP COMP. AXIS-SENSOR LOC 12.13
COMPRESSION PASS 3D.. VIB PLOT 021



ONE HALF PEAK TO PEAK ACCELERATION G

5.0

4.0

3.0

2.0

1.0

0.5

FIG 07

COMPRESSED VIBRATION DATA

CH-47C USA S/N 68-17126
R/C CONFIG-COMB CLFN, SLING AND INTERNAL LOAD;
GND RUN-COMB FLT AND GND IDLE
AVIONICS HIGH FREQ EQUIP COMB AXIS-SENSOR LOC 12-15
COMPRESSION PASS N° 1 VIB PLOT 021

— MEAN ACCELERATION
--- VIBR PLM 2 AXIS UPTR. ACCELERATION LIMIT

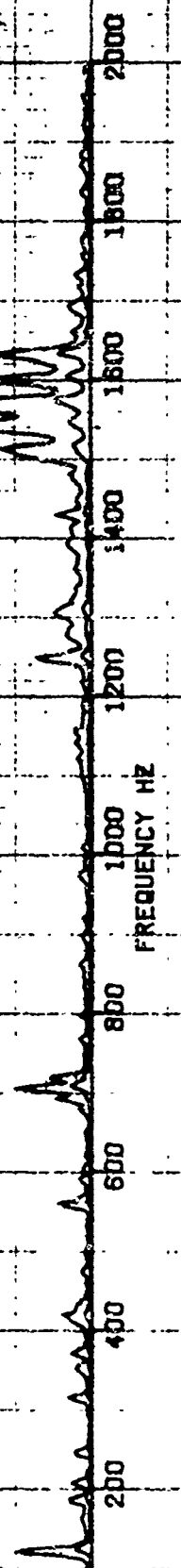

FIG 88
COMPRESSED VIBRATION DATA MAXIMUM ACCELERATION

CH-47C USA S/N 68-17126
A/C CONFIG-COMB CLEAN SLING AND INTERNAL LOAD

FLY COND-HOVER

PILOT AREA VIB INPUT COMB AX18-SENSOR LOC 16, 16, 17, 18, 19
COMPRESSION PASS NO.1 VIB PLOT 022

5.0

4.0

3.0

2.0

1.0

0.0

177

ONE 1/2 PEAK TO PEAK ACCELERATION G

200

400

600

800

1000

1200

1400

1500

1800

2000

FREQUENCY HZ

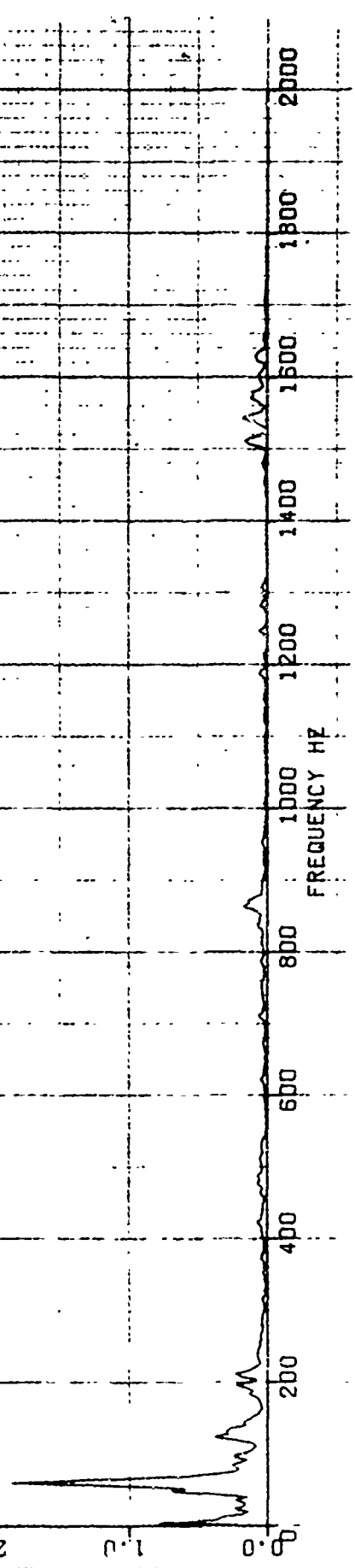

FIG 89 COMPRESSED VIBRATION DATA

CH-47C USA S/N 68-17126
 A/C CONFIG-COMB CLEAN, SLING AND INTERNAL LOAD
 FLT COND-HOVER
 PILOT AREA VIB INPUT COMB AX15-SENSOR LOC 15, 16, 17, 18, 19
 COMPRESSION PASS NO. 1 VIB PLOT 022

MEAN ACCELERATION
 MEAN PLUS 3 SIGMA UPPER ACCELERATION LIMIT

ONE HALF PEAK TO PEAK ACCELERATION G

0.0
1.0
2.0
3.0
4.0
5.0

200 400 600 800 1000 1200 1400 1600 1800 2000

FREQUENCY HZ

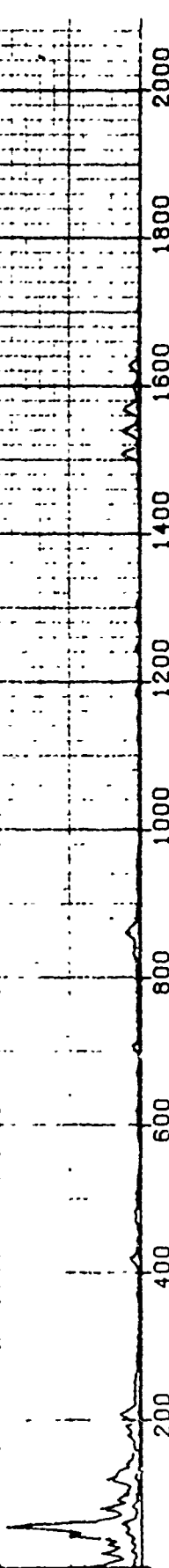

FIG 90
COMPRESSED VIBRATION DATA MAXIMUM ACCELERATION

CH-47C U68 B/N 68-17126
A/C CONFIG-COMB CLEAN, SLING AND INTERNAL LOAD
FLT COND-LEVEL FLT
PILOT AREA VIB INPUT COMB AXIS-SENSOR LOC 15, 16, 17, 18, 19
COMPRESSION PAST NO.1 VIB PLOT 029

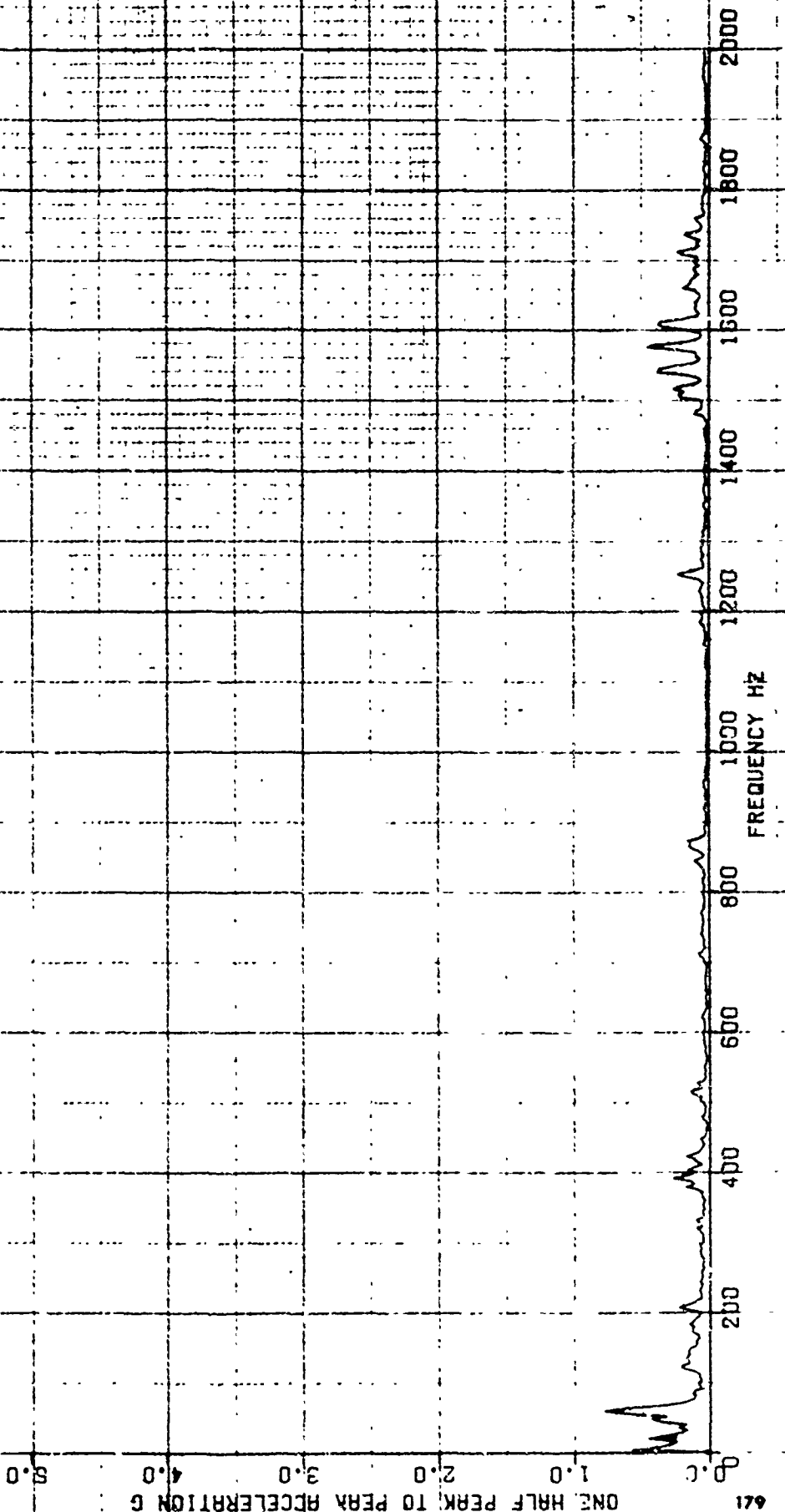

FIG 91
COMPRESSED VIBRATION DATA

CH-47C USB 5/N 68-17125

A/C CONFIG-COMB CLEAN-SLING AND INTERNAL LOAD

FLT COND-LEVEL FLT

PILOT AREA VIB INPUT COMB AXIS-SENSOR LOC 15,16,17,18,19

COMPRESSION PASS NO.1 VIB PLDT 02S

MEAN ACCELERATION

MEAN PLUS 3 SIGMA UPPER ACCELERATION LIMIT

081

ONE HALF PEAK TO PEAK ACCELERATION G

FREQUENCY HZ

2000

1800

1600

1400

1200

1000

800

600

400

200

0

FIG. 92
COMPRESSED VIBRATION DATA MAXIMUM ACCELERATION
CH-47C USA S/N 69-17126
A/C CONFIG-COMB CLEAN, SLING AND INTERNAL LOAD
FLT COND-CLIMB
PILOT AREA VIB INPUT COMB AXIS-SENSOR LOC. 15, 16, 17, 18, 19
COMPRESSION PASS NO. 1 VIB PLOT 024

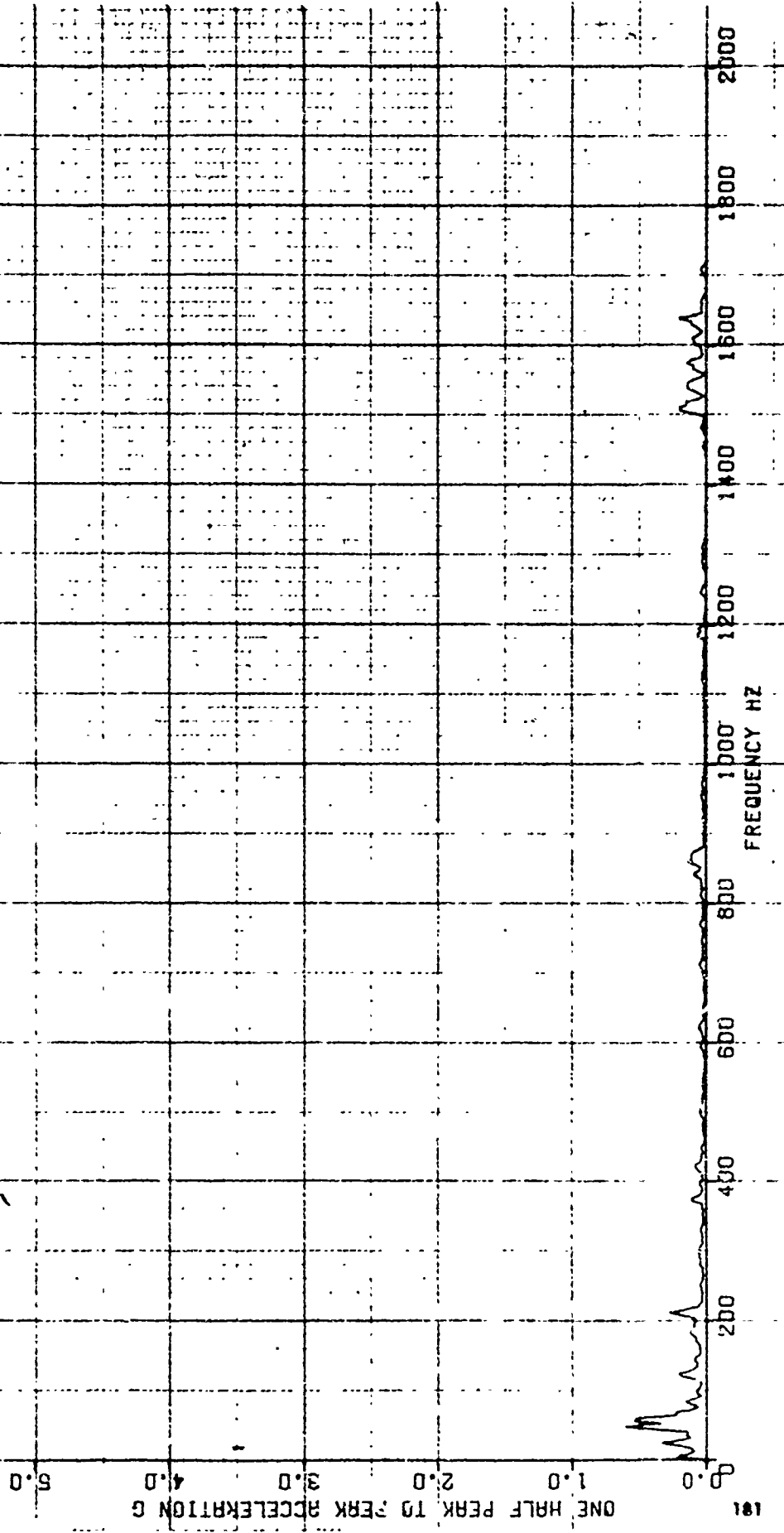

FIG 93
COMPRESSED VIBRATION DATA

CH-47C USA S/N 68-17126

R/C CONFIG-COMB CLEAN, SLING AND INTERNAL LOAD

FLT COND-CLIMB

PILOT AREA VIB INPUT COMB AXIS-SENSOR LOC: 15, 16, 17, 18, 19

COMPRESSION PASS NO. 1 VIB PLOT 524

ONE HALF PEAK TO PEAK ACCELERATION G

5.0

4.0

3.0

2.0

1.0

0.0

FREQUENCY HZ

2000

1800

1600

1400

1200

1000

800

600

400

200

MEAN ACCELERATION

MEAN FLIGHT AREA UPPER ACCELERATION LIMIT



FIG 94
COMPRESSED VIBRATION DATA MAXIMUM ACCELERATION

CH-47C USA S/N 68-17126

A/C CONFIG-COMB CLEAN SLING AND INTERNAL LOAD
FLT COND-DESCENT

PILOT AREA VIB INPUT COMB AXIS-SENSOR LOC 15,16,17,18,19
COMPRESSION PASS NO.1 VIB PLOT 025

ONE HALF PEAK TO PEAK ACCELERATION G
5.0
4.0
3.0
2.0
1.0
0.0

FREQUENCY HZ
200
400
600
800
1000
1200
1400
1600
1800
2000

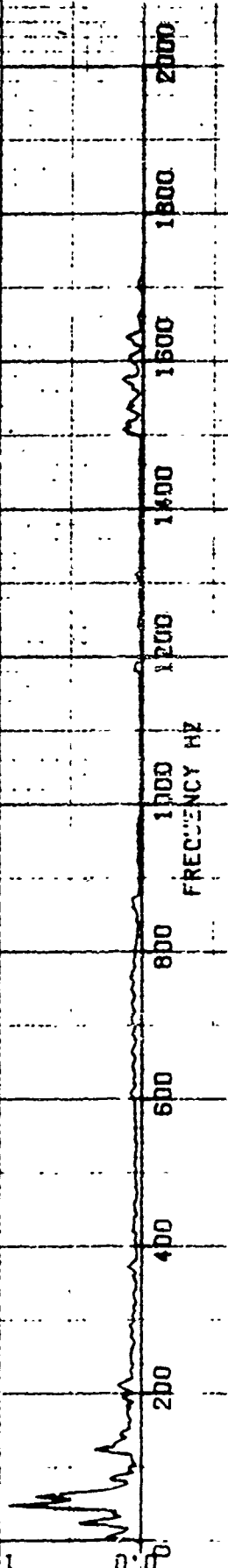

FIG 95

COMPRESSED VIBRATION DATA

CH-47C U68 82N 68-17126
 A/C CONFIG-COMB CLEAN, SLING AND INTERNAL LOAD
 FLT COND-DESCENT
 PILOT AREA VIB INPUT COMB AXIS-SENSOR LOC. 15, 16, 17, 18, 19
 COMPRESSION PROC NO. 1 VIB PLOT 025

W/AVG ACCELERATION
 X-AXIS UPPER LACCELERATION (1 IN)

ONE HALF PEAK TO PEAK ACCELERATION G

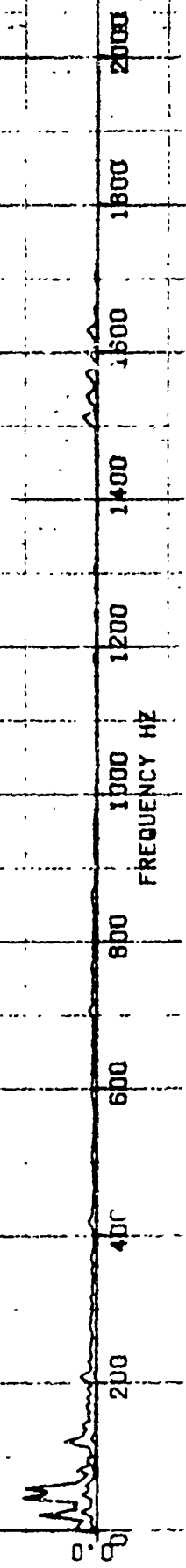

FIG 96
COMPRESSED VIBRATION DATA MAXIMUM ACCELERATION

CH-47C USA 67N 68-17126
A/C CONFIG CLEAN SLING AND INTERNAL LOAD
FLT COND-COMB T/O AND LOGS
PILOT AREA VIB INPUT COMB AXIS-SENSOR LDC 15, 16, 17, 18, 19
COMPRESSION PASS NO. 1 VIB PLOT 026

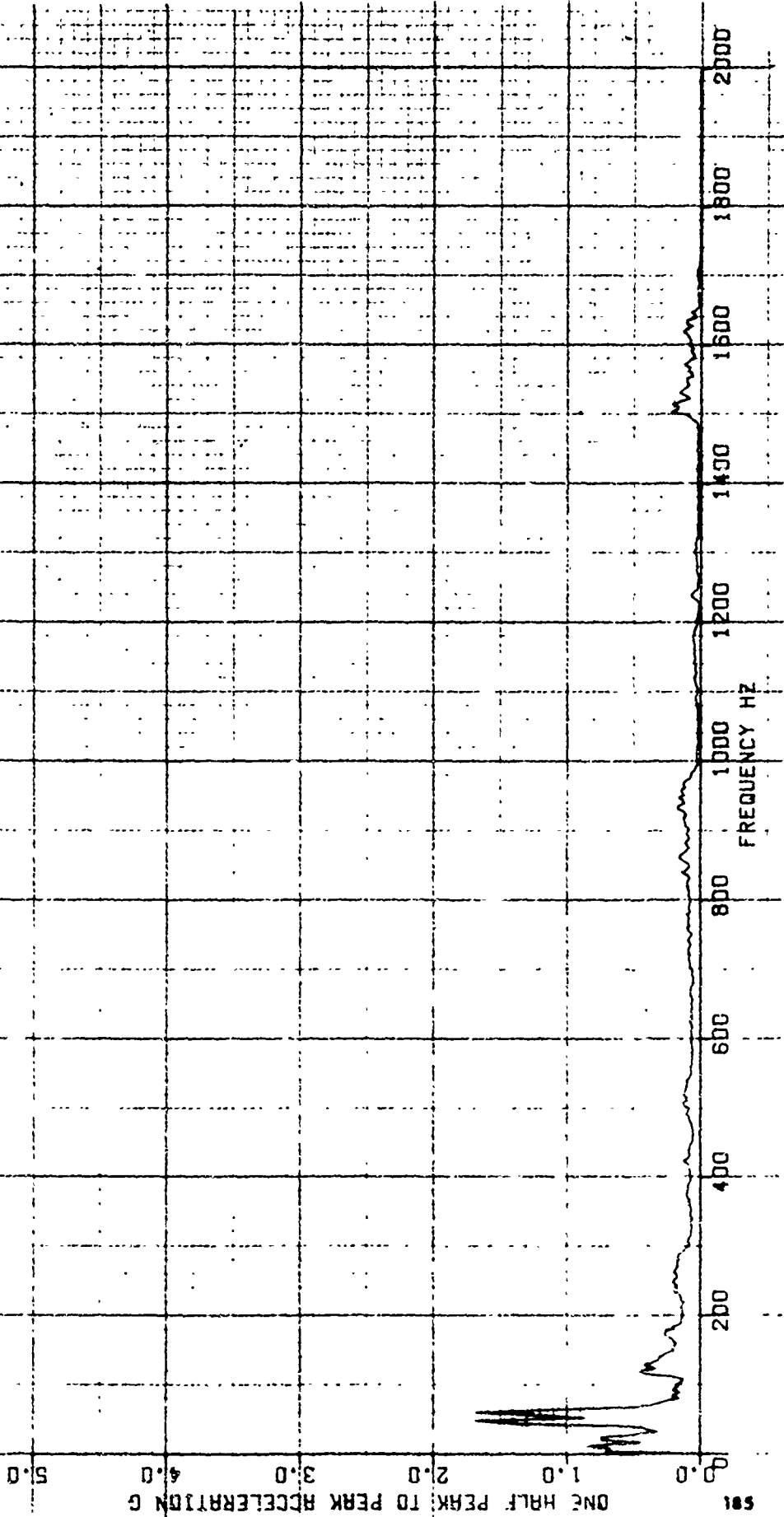

FIG 97 COMPRESSED VIBRATION DATA

CH-47C, USA S/N 68-17126
 A/C CONFIG COMB CLEANSLING AND INTERNAL LOAD
 FLT COND-COMB T/O AND LOGS
 PILOT AREA VIB INPUT COMB AX16-SENSOR LDC 16.16.17.18.18
 COMPRESSION PASS NO.1 VIB PLOT 026

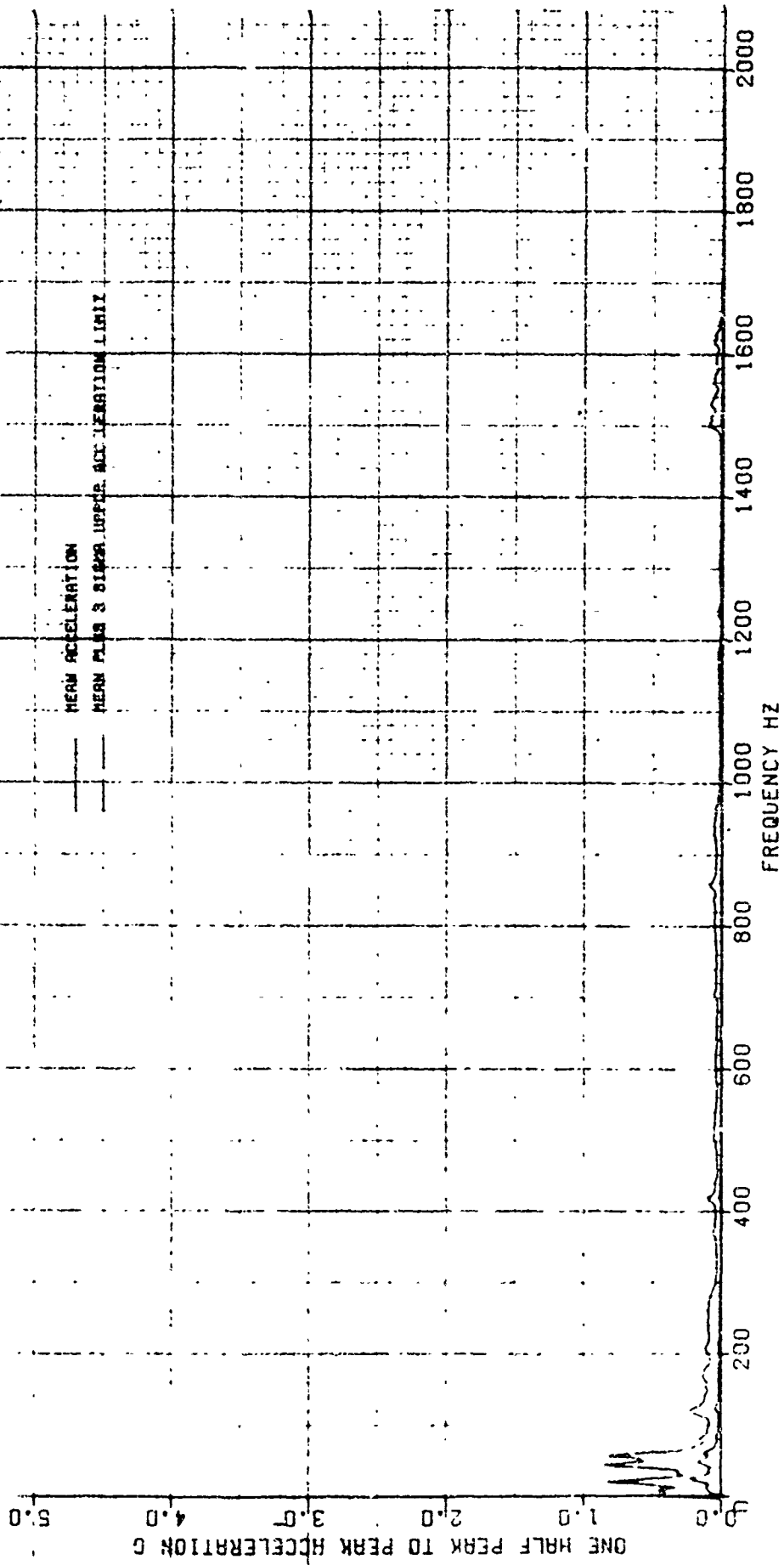

FIG 98
COMPRESSED VIBRATION DATA MAXIMUM ACCELERATION

CH-47C USA S/N 68-17126
A/C CONFIG-COMB CLEAN, SLING AND INTERNAL LOAD
FLT COND-COMB MANEUVERS
PILOT AREA VIB INPUT COMB AXIS-SENSOR LOC. 15, 16, 17, 18, 19
COMPRESSION PASS NO.: VIB PLOT 027

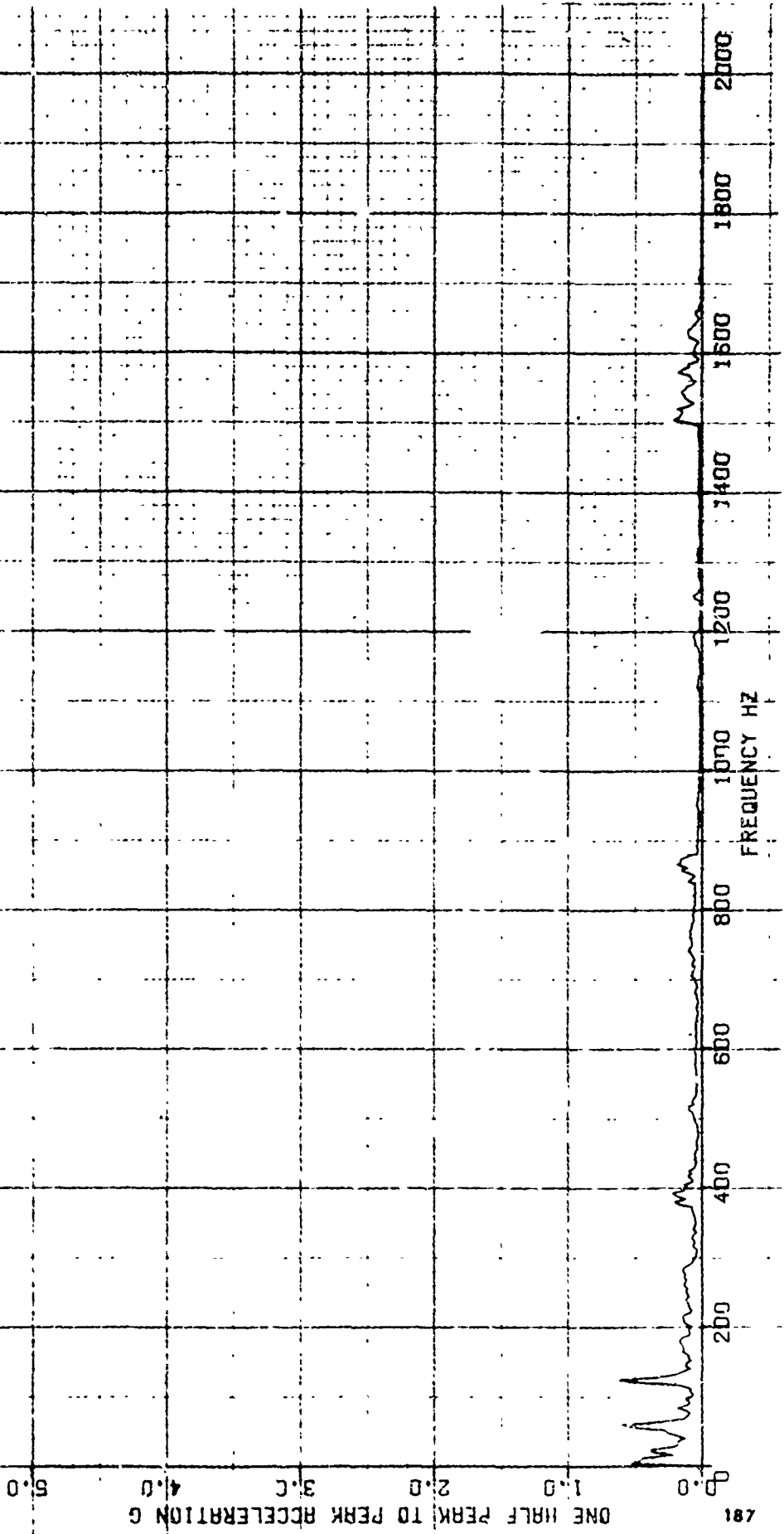

FIG 99
COMPRESSED VIBRATION DATA

CH-47C USAF B/N 68-17126
A/C CONFIG-COMB CLEAN, SLING AND INTERNAL LOAD
FLT COND-COMB MANEUVERS
PILOT AREA VIB INPUT COMB AXIS-SENSOR, LOC. 15, 16, 17, 18, 19
COMPRESSION PASS NO. 1 VIB PLOT 027

— MEAN ACCELERATION
— MEAN PLUS 3 SIGMA UPPER ACCELERATION LIMIT

ONE HALF PEAK TO PEAK ACCELERATION G

FREQUENCY HZ

2000

1600

1500

1400

1200

1000

800

600

400

200

0.0

5.0

4.0

3.0

2.0

1.0

0.0

FIG 100
COMPRESSED VIBRATION DATA MAXIMUM ACCELERATION

CH-47C USA B/N 68-17126
A/C CONFIG CLEAN, SLING AND INTERNAL LOAD
GND RUN-COMB FLT AND GND IDLE
PILOT AREA VIB INPUT COMB AXIS-SENSOR. LOC 16, 18, 17, 18, 19.
COMPRESSION PASS NO. 1. VIB PLOT 026

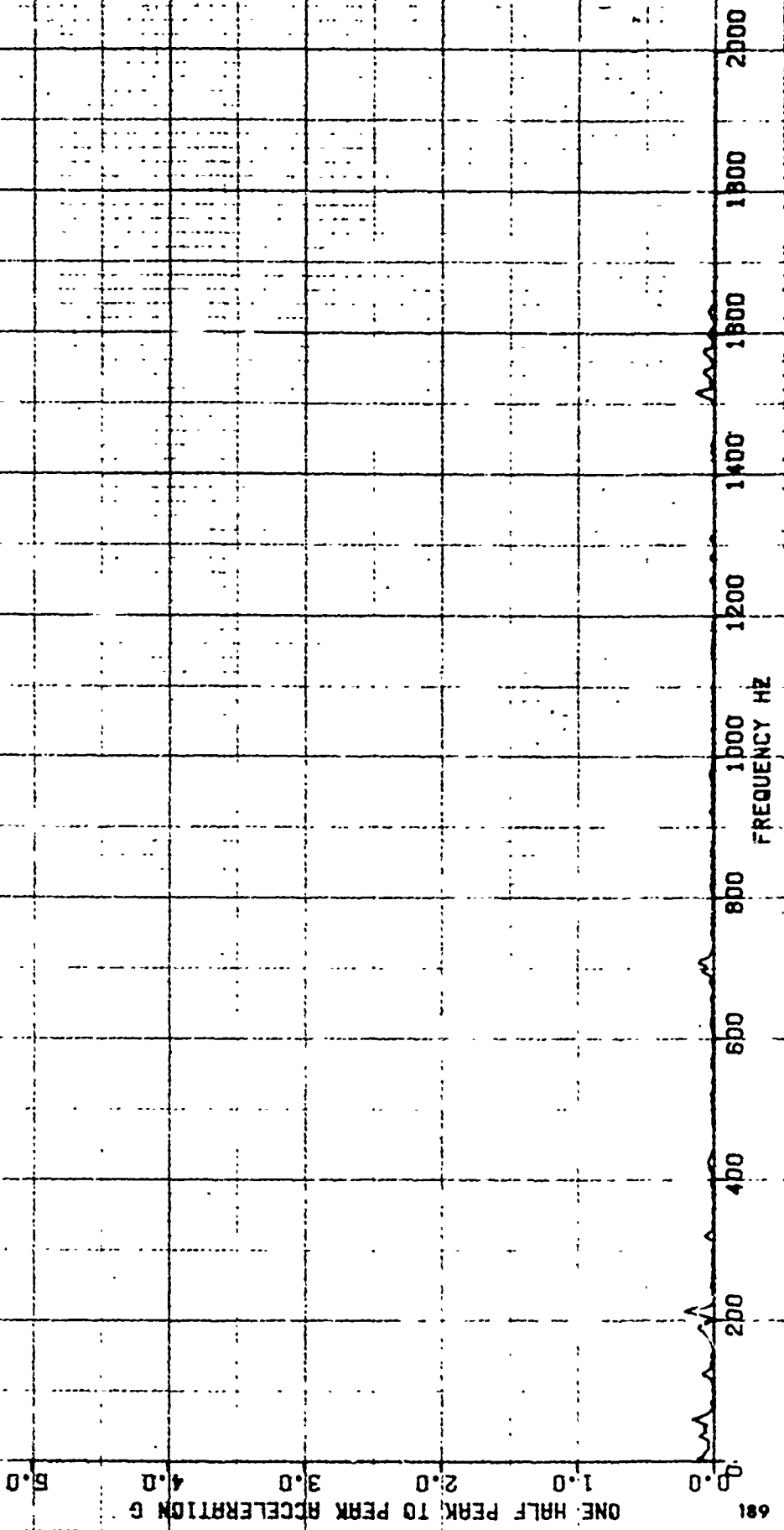

FIG 101
COMPRESSED VIBRATION DATA

CA-47C UBR S/M 88-1712B
R/C CONFIG-COMB CLEAN, SLING, AND INTERNAL LOAD
GND RUN-COMB FLT AND GND IDLE
PILOT AREA VIB INPUT COMB AXIS-SENSOR LOC. 15, 16, 17, 18, 19
COM-MESSON PASS NO. 1 - VIB PLOT 028

MEAN ACCELERATION
MEAN VALUE A BELOW UPPER ACCELERATION LIMIT

ONE HALF PEAK TO PEAK ACCELERATION G

0.0

1.0

2.0

3.0

4.0

5.0

200 400 600 800 1000 1200 1400 1600 1800 2000

FREQUENCY HZ

FIG 102
COMPRESSED VIBRATION DATA MAXIMUM ACCELERATION

CH-47C USA S/N 69-17126
A/C CONFIG-COMB CLEAN SLING AND INTERNAL LOAD
FLT COND-HOVER
PILOT OUTPUT VIB COMB AXIS-SENSOR LOC 20.21
COMPRESSION PASS NO.1 VIB PLOT 028

ONE HALF PEAK TO PEAK ACCELERATION G
0.0
0.4
0.8
1.2
1.6
2.0

FREQUENCY HZ
0
200
400
600
800
1000
1200
1400
1600
1800
2000

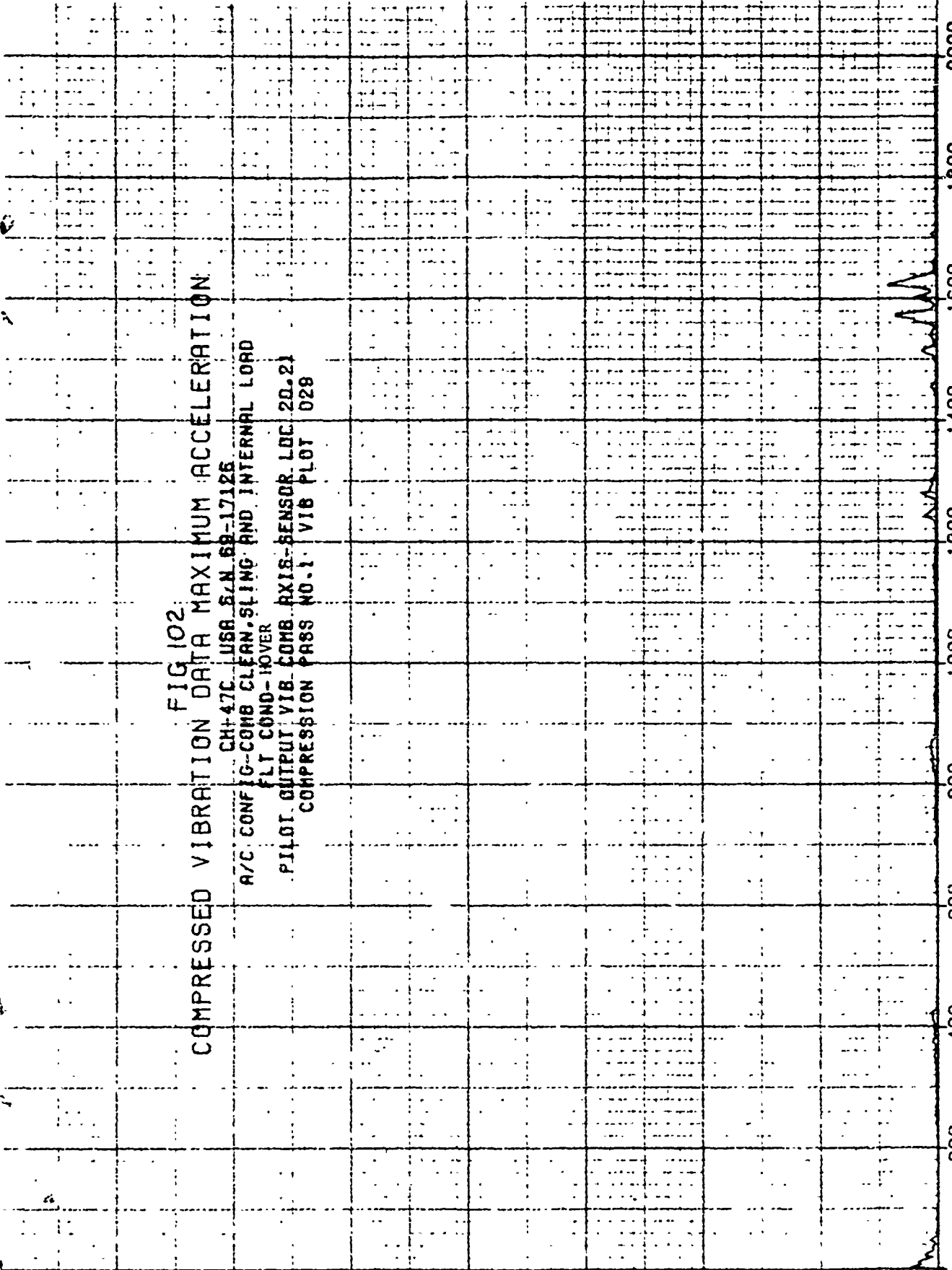

FIG 103

COMPRESSED VIBRATION DATA

CH-47C USAF 57N 59-17126
A/C CONFIG-COMB CLEAN, SLING AND INTERNAL LOAD
FLT COND-HOVER

PILOT OUTPUT VIB. COMB. AXIS-SENSOR LOC. 20.21
COMPRESSION PASS NO. 1 VIB PLOT 029

MEAN ACCELERATION
MEAN PLUS 2 SIGMA UPPER ACCELERATION LIMIT

ONE HALF PEAK TO PEAK ACCELERATION G

FREQUENCY HZ

200 400 600 800 1000 1200 1400 1600 1800 2000

Handwritten signature

FIG 104
COMPRESSED VIBRATION DATA MAXIMUM ACCELERATION

CH-57C USA S/N 68-17126
R/C CONFIG-COMB CLEAN, SLING AND INTERNAL LOAD
FLY COND-LEVEL FLY
PILOT OUTPUT VIB COMB AXIS-SENSOR LJC 20-21
COMPRESSION PASS NO.1 VIB PLOT 080

ONE HALF PEAK TO PEAK ACCELERATION G
2.0
1.6
1.2
0.8
0.4
0.2
0

FREQUENCY HZ
200
400
600
800
1000
1200
1400
1600
1800
2000

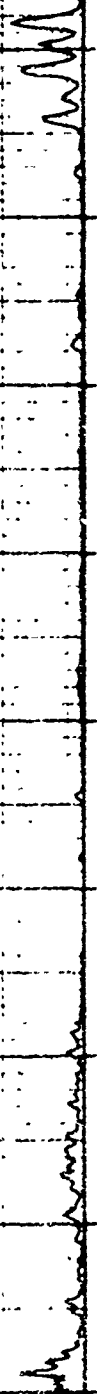

FIG 105

COMPRESSED VIBRATION DATA

CH-47C USA S/N 68-17126
RYC CONFIG-COMB CLEAN, SLING AND INTERNAL LOAD
FLT COND-LEVEL FLT
PILOT OUTPUT VIB COMB AXIS-SENSOR LOC 20.21
COMPRESSION PASS NO.1 VIB PLOT PSD

NON-ACCELERATION
NON-FLIGHT-STATUS UPPER ACCELERATION LIMIT

ONE HALF PEAK TO PEAK ACCELERATION G
0.4
0.8
1.2
1.6
2.0

FREQUENCY HZ

200 400 500 800 1000 1200 1400 1600 1800 2000

AS W

FIG 106
COMPRESSED VIBRATION DATA MAXIMUM ACCELERATION

CH-47C USA S/N 68-17126
A/C CONFIG-COMB CLEAN, SLING, AND INTERPIL LOAD
FLT COND-CLIMB
PILOT OUTPUT VIB COMB AXIS SENSOR LOC 20.21
COMPRESSION PASS NO.1 VIB PLOT 031

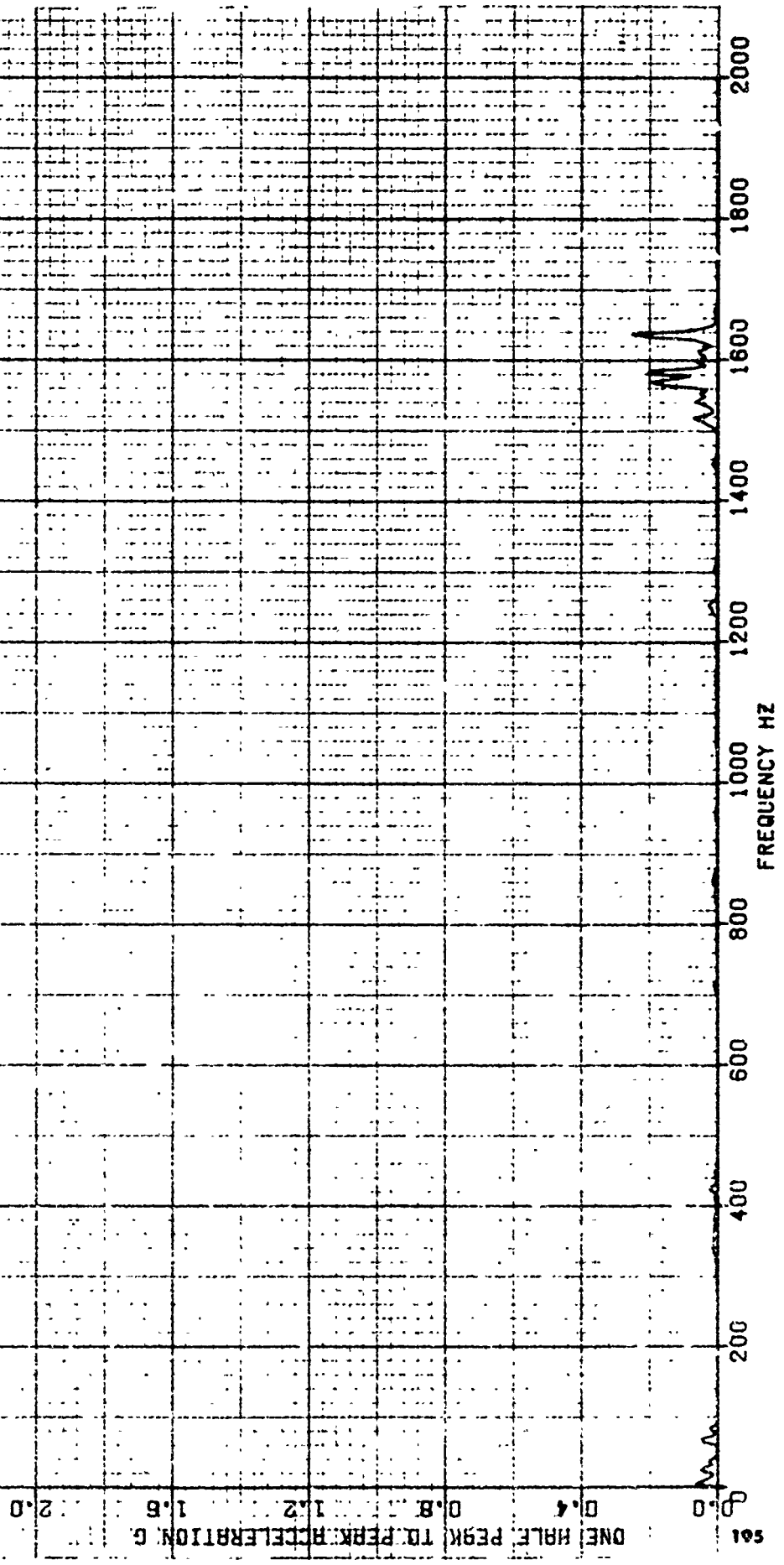

FIG 107

COMPRESSED VIBRATION DATA

CH-47C USA S/N 68-17126
R/C CONFIG-COMB CLEAN, SLING AND INTERNAL LOAD
FLT COND-CLIMB
PILOT OUTPUT VIB COMB AXIS-SENSOR LOC 20.21
COMPRESSION PASS NO.1 VIB PLOT 031

Peak Acceleration
Mean Plan 1 Along X-Direction

ONE HALF PEAK TO PEAK ACCELERATION G
2.0
1.5
1.2
0.8
0.4
0.2

2000
1800
1600
1400
1200
1000
800
600
400
200
FREQUENCY HZ



FIG 108
COMPRESSED VIBRATION DATA MAXIMUM ACCELERATION

CH-47C USA S/N 68-17126
A/C CONFIG-COMB CLEAN, SLING AND INTERNAL LOAD
FLT COND-DESCENT
PILOT OUTPUT VIB COMB AXIS-SENSOR LOC 20.21
COMPRESSION PASS NO.1 VIB PLOT 092

ONE HALF PEAK TO PEAK ACCELERATION G
2.0
1.6
1.2
0.8
0.4
0.0

200 400 600 800 1000 1200 1400 1600 1800 2000
FREQUENCY HZ

Handwritten scribble

FIG 109 COMPRESSED VIBRATION DATA

CH-47C USA S/N 68-17126
A/C CONFIG-COMB CLEAN, SLING AND INTERNAL LOAD
FLT COND-DESCENT
PILOT OUTPUT VIB COMB AXIS-SENSOR LOC 20.21
COMPRESSION PASS NO.1 VIB PLOT DS2

ONE HALF PEAK TO PEAK ACCELERATION G
2.0
1.6
1.2
0.8
0.4
0.2

HEAVY ACCELERATION
HEAVY PLUN & SHOCK UPPER ACCELERATION LIMIT

FREQUENCY HZ

2000

1800

1600

1400

1200

1000

800

600

400

200

0

Handwritten scribble

FIG 119
COMPRESSED VIBRATION DATA MAXIMUM ACCELERATION

CH-47C USB S/N 68-17126
A/C CONFIG-COMB CLEAN, SLING AND INTERNAL LOAD
FLT COND-COMB T/O AND LOGS
PILOT OUTPUT: VIB COMB AXIS-SENSOR LOC 20-21
COMPRESSION PASS NO.1 VIB PLOT 033

ONE HALF PEAK TO PEAK ACCELERATION G
2.0
1.6
1.2
0.8
0.4
0.0

FREQUENCY HZ
200 400 600 800 1000 1200 1400 1600 1800 2000

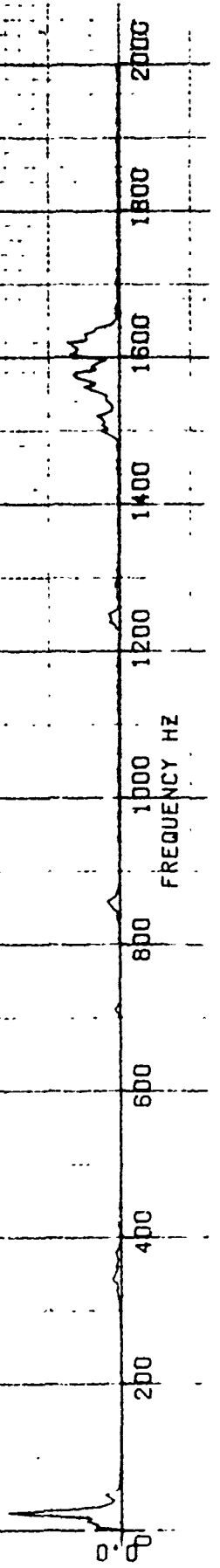

FIG III COMPRESSED VIBRATION DATA

CH-47C USA S/N 65-1712E
A/C CONFIG-COMB CLEANSLING AND INTERNAL LOAD
FLT COND-COMB T/O AND LOGS
PILOT OUTPUT VIB COMB AXIS-SENSOR LOC 2D.21
COMPRESSION PASS NO.1 VIB PLOT 058

MEAN ACCELERATION
MEAN PLUS 3-SIGMA UPPER ACCELERATION LIMIT

992

ONE HALF PEAK TO PEAK ACCELERATION G
2.0
1.6
1.2
0.8
0.4
0.0

FREQUENCY HZ
200 400 600 800 1000 1200 1400 1600 1800 2000

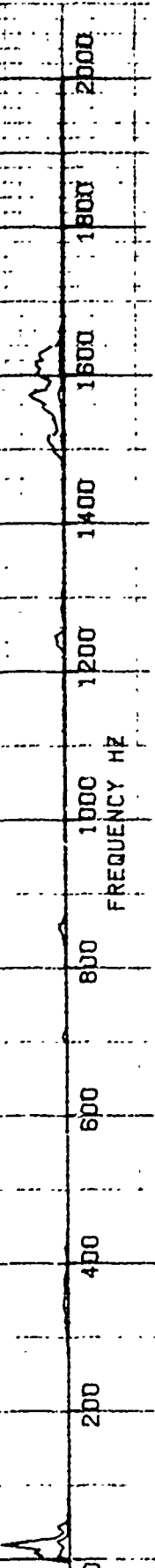

FIG 112
COMPRESSED VIBRATION DATA MAXIMUM ACCELERATION

CR47C USA S/N 68-17126
A/C CONFIG-COMB CLEAN, SLING AND INTERNAL LOAD
FLT COND-COMB MANEUVERS
PILOT OUTPUT VIB COMB AXIS-SENSOR LOC 20.21
COMPRESSION PASS NO.1 VIB PLOT 034

ONE HALF PEAK TO PEAK ACCELERATION G
0.0 0.4 0.8 1.2 1.6 2.0

200 400 600 800 1000 1200 1400 1600 1800 2000
FREQUENCY HZ



FIG 113
COMPRESSED VIBRATION DATA

CH-47C USA S/N 68-17126
A/C CONFIG-COMB CLEAN, SLING AND INTERNAL LOAD
FLT COND-COMB MANEUVERS
PILOT OUTPUT VIB COMB AXIS-SENSOR LOC 20.21
COMPRESSION PASS NO. 1 VIB PLOT 034

MEAN ACCELERATION
MEAN PLUS 3 SIGMA UPPER ACCELERATION LIMIT

ONE HALF PEAK TO PEAK ACCELERATION G
0.0
0.4
0.8
1.2
1.6
2.0

FREQUENCY HZ
200
400
600
800
1000
1200
1400
1600
1800
2000

Handwritten signature

FIG 114
COMPRESSED VIBRATION DATA MAXIMUM ACCELERATION

CH-47C USAF S/N 69-17126
A/C CONFIG-COMB CLEAN, BLINS AND INTERNAL LOXO
GND RUN-COMB 1LT AND GND IDLE
PILOT OUTPUT VIB COMB AXIS-SENSOR LOC. 20.21
COMPRESSION PASS NO.1 VIB PLOT DB6

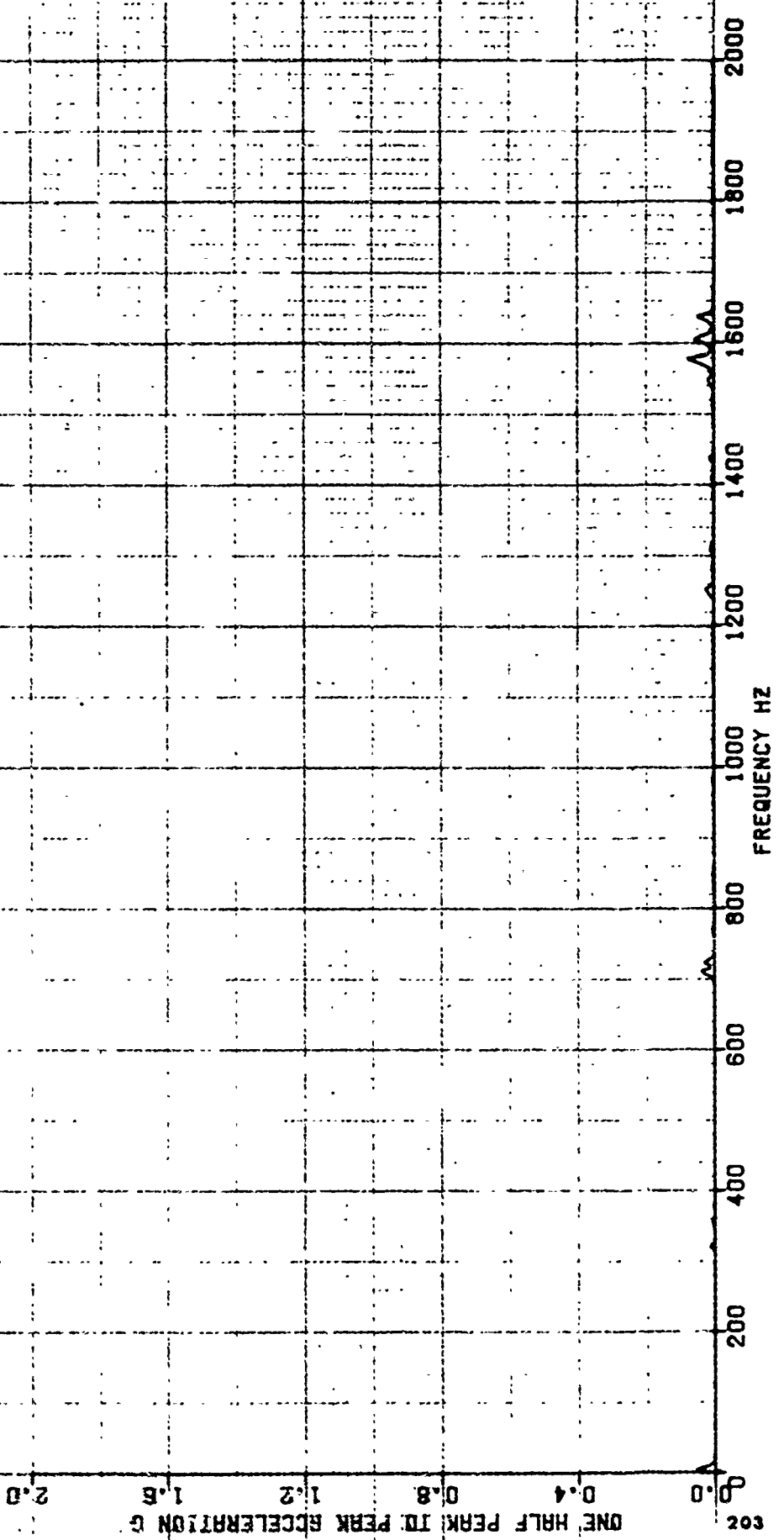

FIG 115

COMPRESSED VIBRATION DATA

CH-47C, USB S/N 68-17126
A/C CONFIG-COMB CLEAN, SLING AND INTERNAL LOAD
GND RUN-COMB FLT AND GND IDLE
PILOT OUTPUT VIB COMB AXIS-SENSOR LOC 20.21
COMPRESSION PASS NO.1 VIB PLOT 095

— MAIN ACCELERATION
— MAIN PLUS 3 SIGMA UPPER ACCELERATION LIMIT

ONE HALF PEAK TO PEAK ACCELERATION G
0.0 0.4 0.8 1.2 1.6 2.0

FREQUENCY HZ

200 400 600 800 1000 1200 1400 1500 1800 2000

AAA

0
A

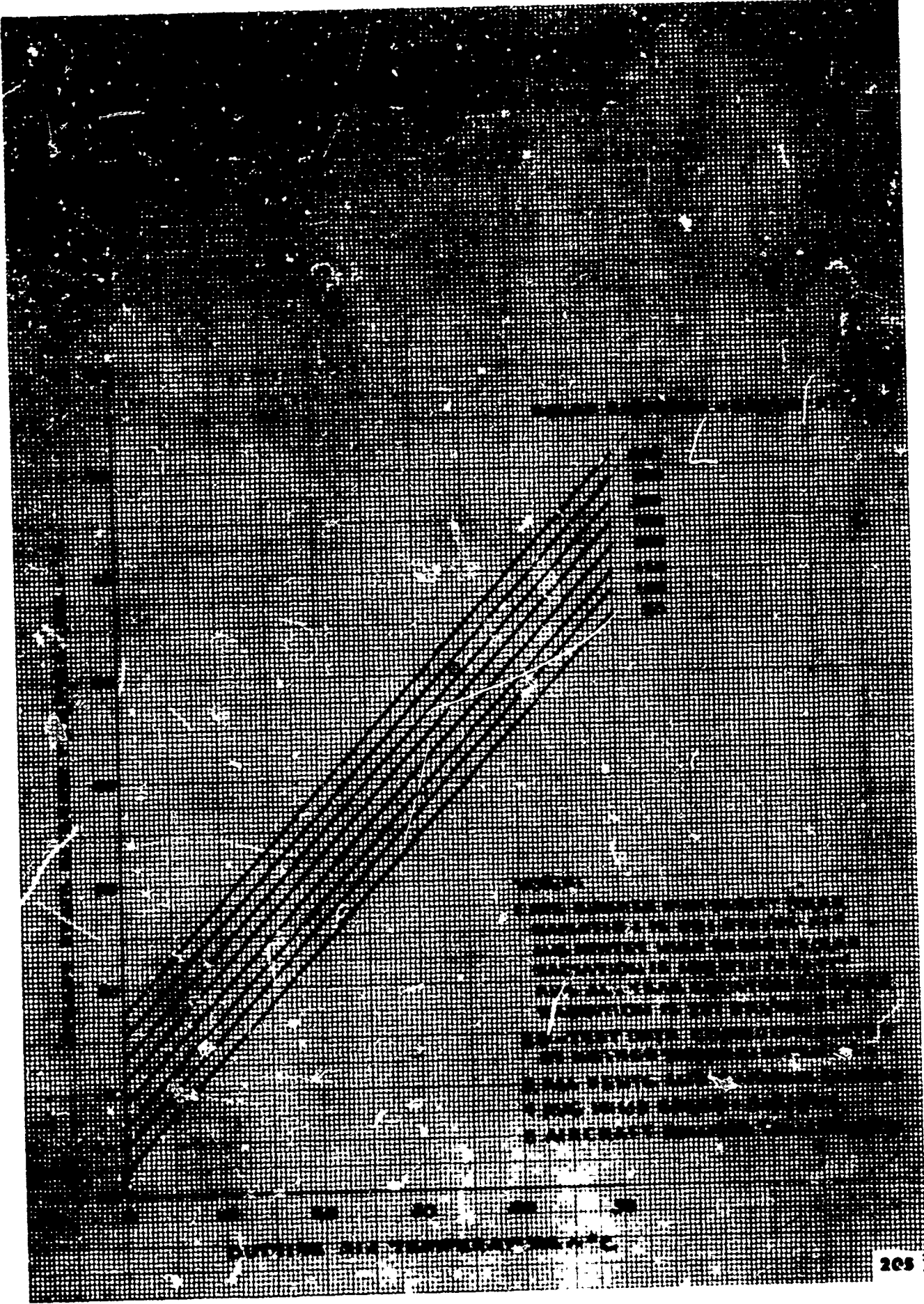

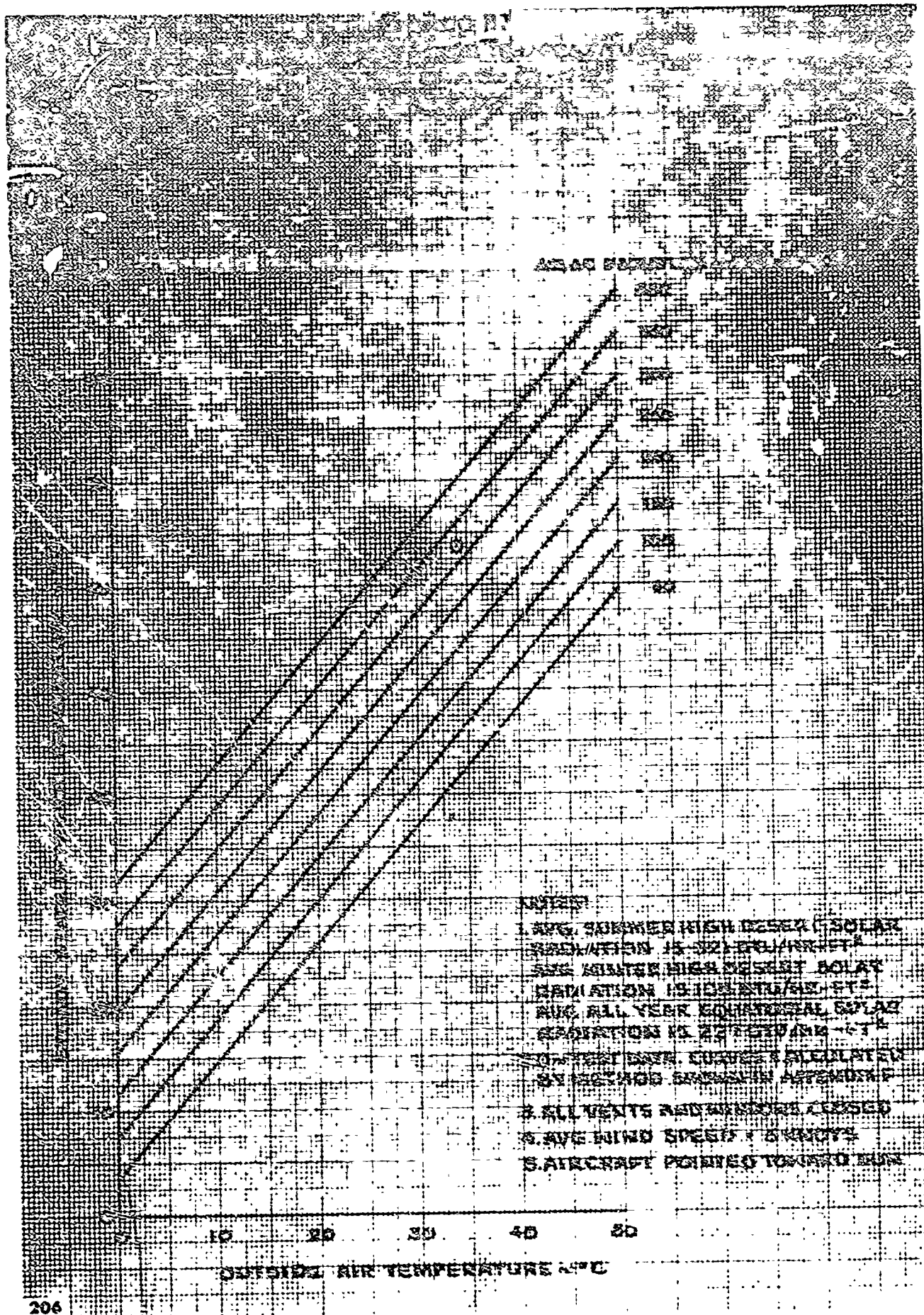

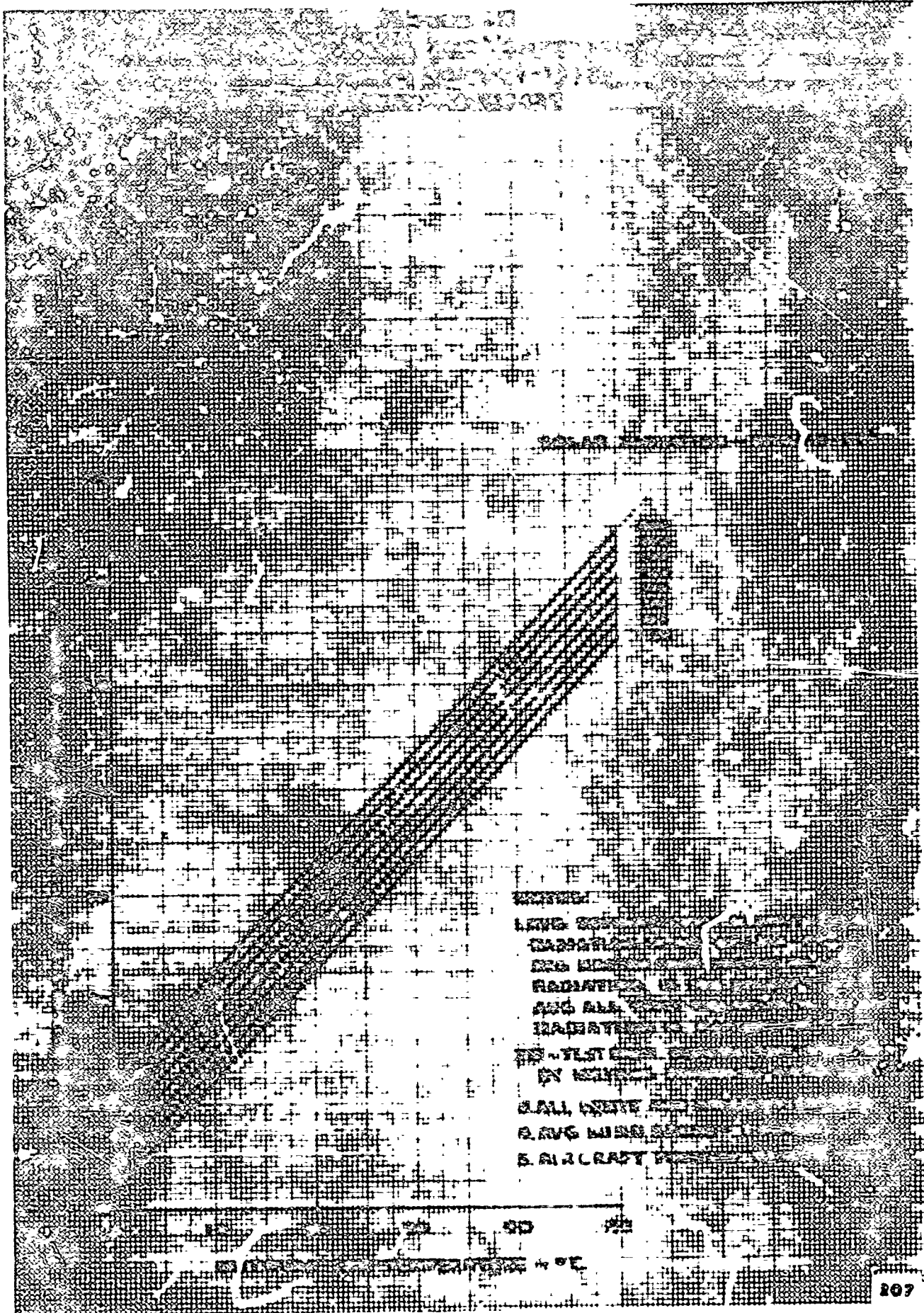
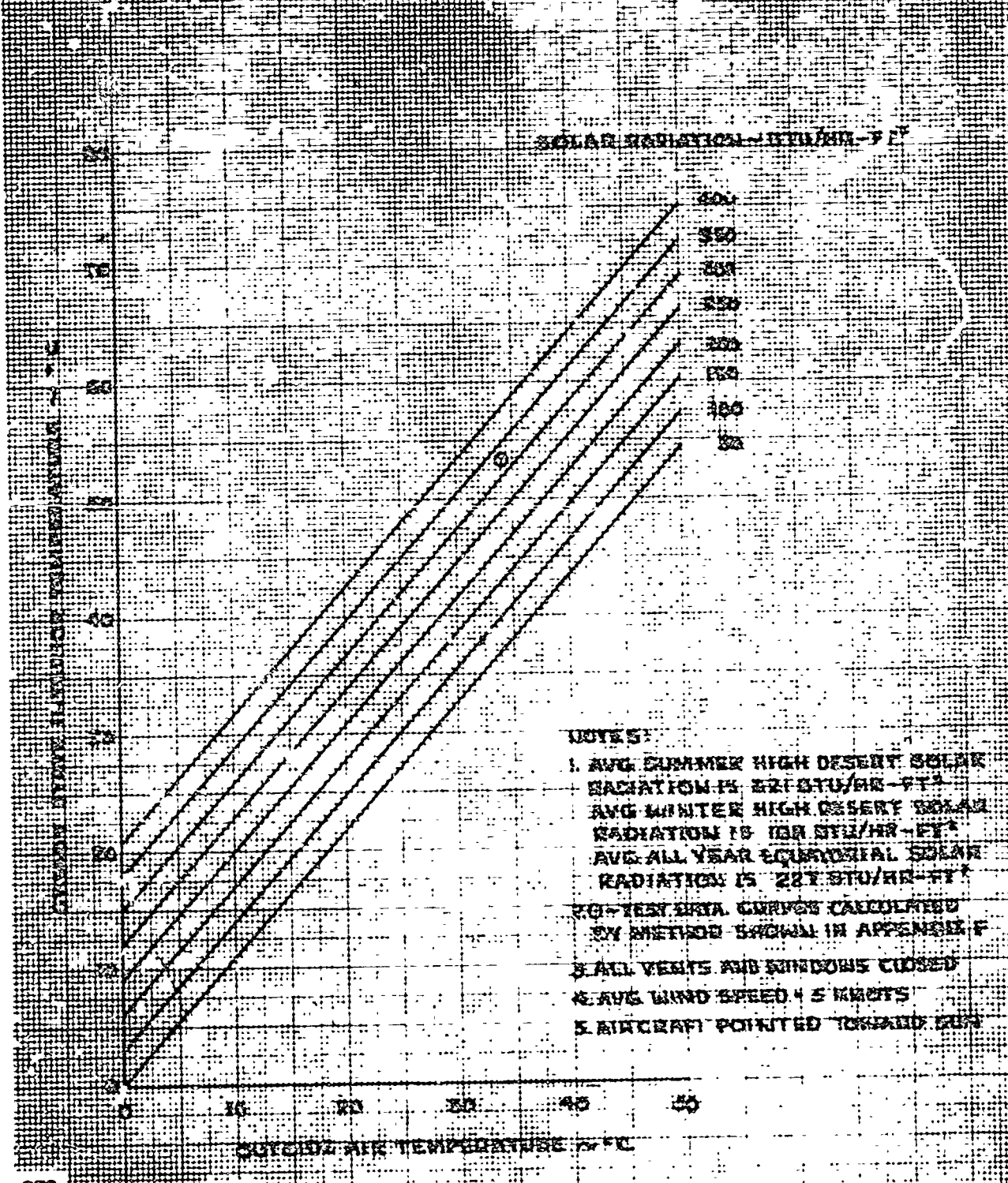

Figure 10
 Heating Load Temperature
 Correction Factors
 (See also Figure 9)



SOLAR RADIATION - BTU/HR - FT²

NOTES:

- 1. AVG. SUMMER HIGH DESERT SOLAR RADIATION IS 521 BTU/HR - FT²
- 2. AVG. WINTER HIGH DESERT SOLAR RADIATION IS 109 BTU/HR - FT²
- 3. AVG. ALL YEAR EQUATORIAL SOLAR RADIATION IS 227 BTU/HR - FT²
- 4. TEST DATA CURVES CALCULATED BY METHOD SHOWN IN APPENDIX F
- 5. ALL VENTS AND WINDOWS CLOSED
- 6. AVG. WIND SPEED 4.5 KNOTS
- 7. AIRCRAFT POINTED TOWARD SUN

OUTSIDE AIR TEMPERATURE - °F

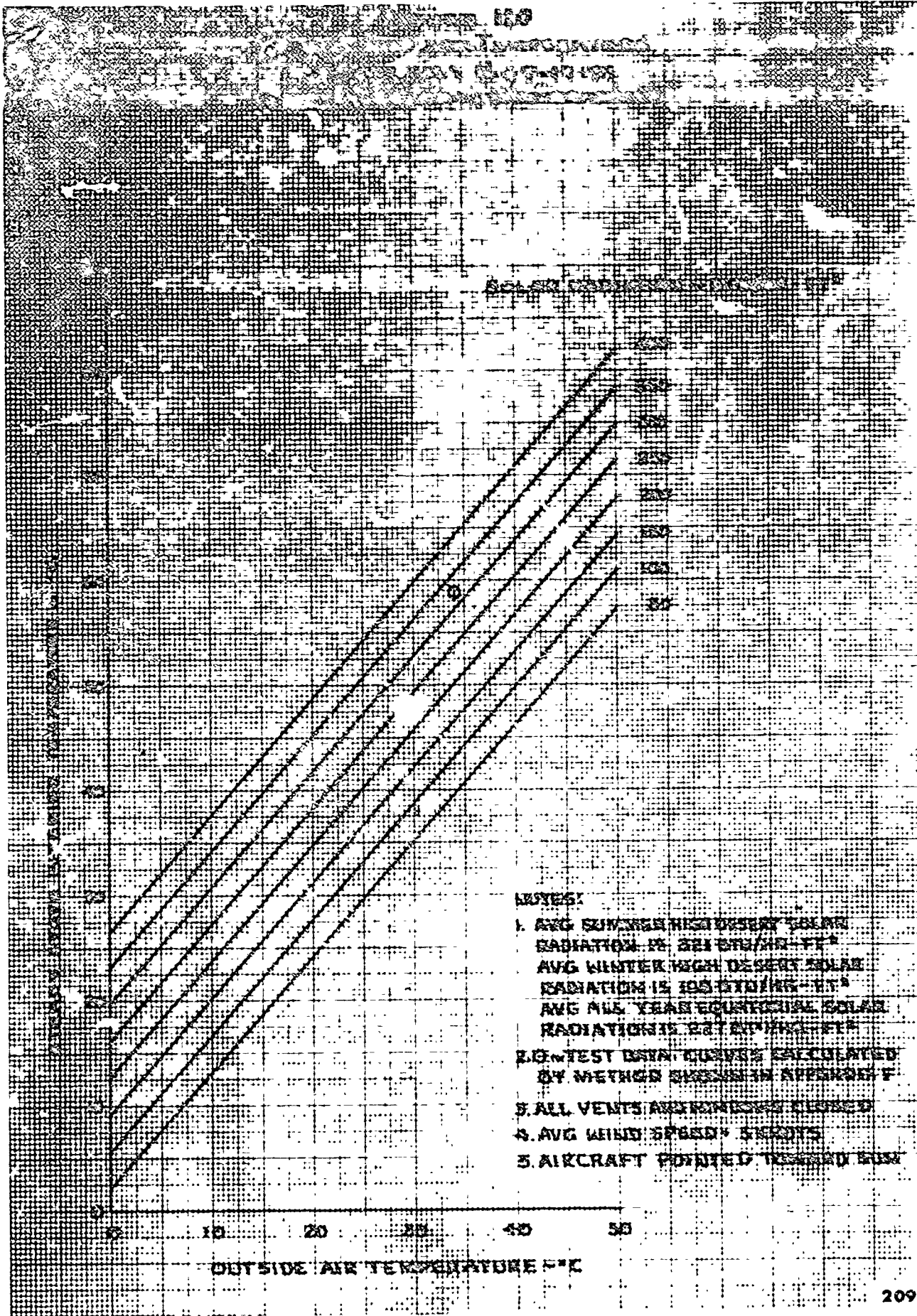

NOTES:

1. AVG SUMMER HIGH DESERT SOLAR RADIATION IS 321 BTU/HR-FT²
2. AVG WINTER HIGH DESERT SOLAR RADIATION IS 100 BTU/HR-FT²
3. AVG ALL-YEAR EQUATORIAL SOLAR RADIATION IS 247 BTU/HR-FT²
4. TEST DATA CURVES CALCULATED BY METHOD SHOWN IN APPENDIX F
5. ALL VENTS AUTOMATICALLY CLOSED
6. AVG WIND SPEED* 5 KNOTS
7. AIRCRAFT POINTED TOWARD SUN

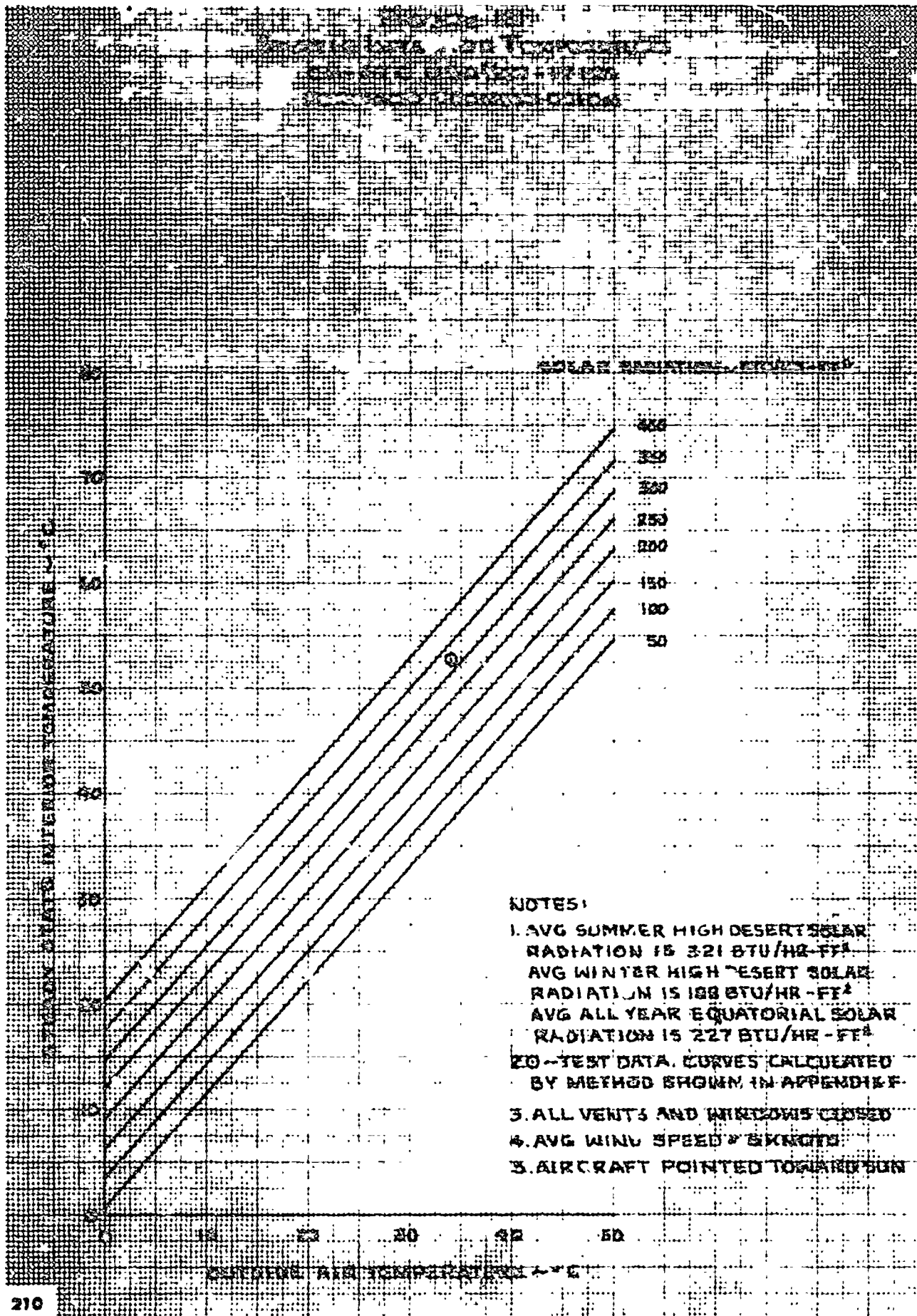

NOTES:

1. AVG SUMMER HIGH DESERT SOLAR RADIATION IS 321 BTU/HR-FT²
2. AVG WINTER HIGH DESERT SOLAR RADIATION IS 188 BTU/HR-FT²
3. AVG ALL YEAR EQUATORIAL SOLAR RADIATION IS 227 BTU/HR-FT²
- 20 - TEST DATA. CURVES CALCULATED BY METHOD SHOWN IN APPENDIX F
3. ALL VENTS AND WINDOWS CLOSED
4. AVG WIND SPEED 4.6 KNOTS
5. AIRCRAFT POINTED TOWARD SUN

FIGURE 122
 STATIC INTERIOR TEMPERATURE
 CH-47C USA WING-1126G
 HANGER 03A001C 1

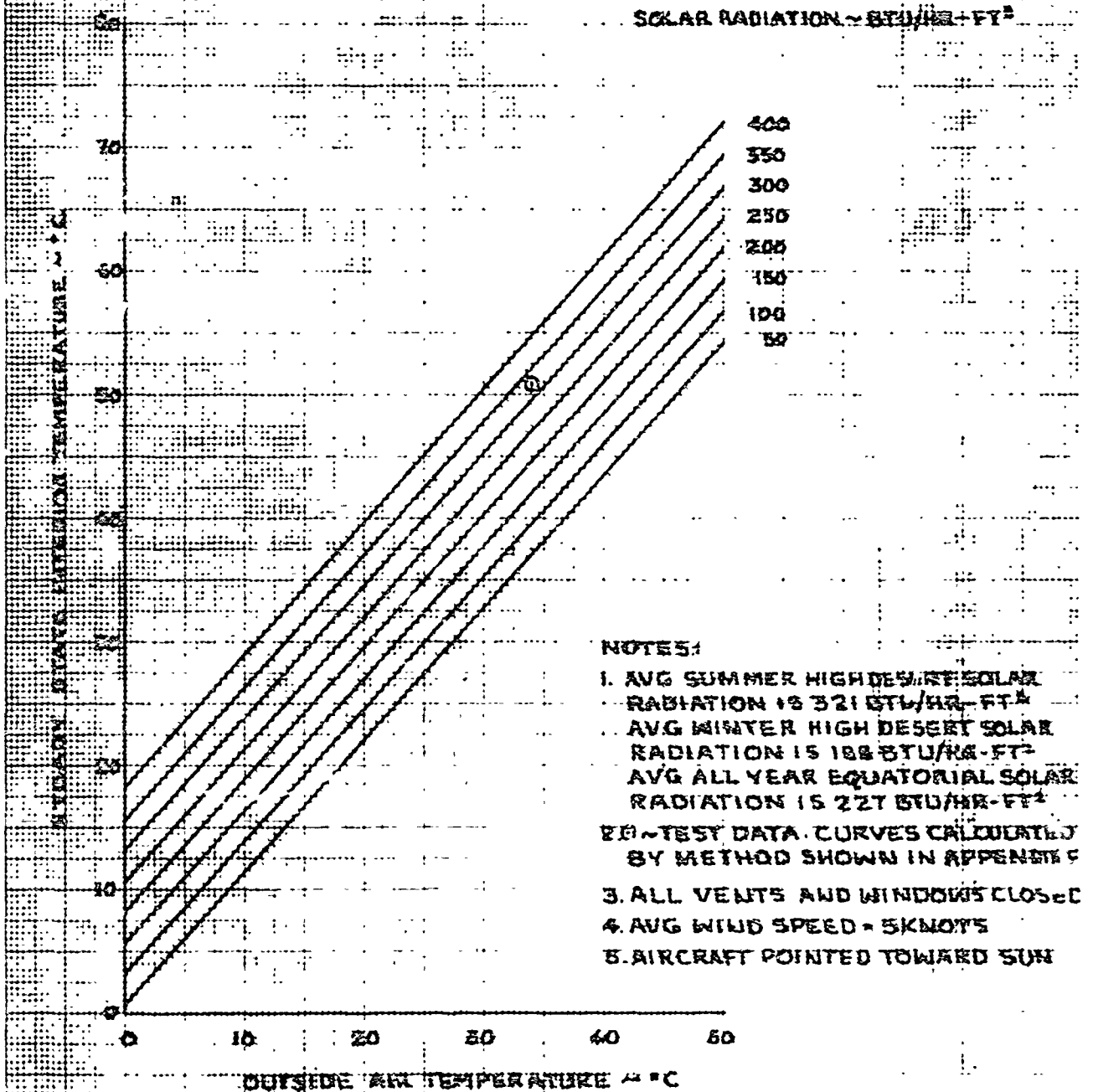

APPENDIX F. GLOSSARY

<u>ABBREVIATION</u>	<u>DEFINITION</u>
Config	Configuration
Comb	Combined
Fwd	Forward
GW	Gross weight
H	Longitudinal axis
Hz	Hertz
IGE	In ground effect
In.	Inches
KCAS	Knots calibrated airspeed
L	Lateral axis
Lb	Pound
Ldg	Landing
LF	Level flight
Li	Left
N ₁	Engine gas producer turbine
N ₂	Engine power turbine
OGE	Out of ground effect
PTIT	Power turbine inlet temperature
Rt	Right
R/C	Rate of climb
R/D	Rate of descent
RPM	Revolutions per minute
SHP	Shaft horsepower
T/O	Takeoff
V	Vertical axis
V _{NE}	Never-exceed airspeed
V _H	Maximum airspeed for level flight
V _{loiter}	Airspeed for maximum endurance
V _{best R/C}	Airspeed for maximum rate of climb
V _{cruise R/C}	Airspeed for cruise rate of climb

V_{\min} R/D

V_{500} fpm R/D

15 right

15 left

30 right

30 left

Airspeed for minimum rate
of descent

Cruise descent at 500 feet
per minute

15-degree right bank

15-degree left bank

30-degree right bank

30-degree left bank